

2011



Strategic Planning for Florida Governmental Broadband Capabilities

Prepared for the Florida Department of Management Services
By the Public Utility Research Center at the University of Florida



Strategic Planning for Florida Governmental Broadband Capabilities

Volumes 1 and 2

Prepared for

Florida Department of Management Services
4030 Esplanade Way
Tallahassee, Florida 32399-0950

Prepared by

David Brevitz
Herb Cash
Mary Galligan
Lynne Holt, Ph.D.
Theodore Kury
Mark Jamison, Ph.D.
Public Utility Research Center
University of Florida
P.O. Box 117142
Gainesville, Florida 32611-7142
<http://www.purc.ufl.edu>

February 28, 2011

Acknowledgements

A project of this magnitude does not succeed without the help of a large number of people. We would like to acknowledge at least some of them.

The integration of broadband into government operations made it essential for us to gather facts and viewpoints from numerous persons. We interviewed numerous agency and network managers, who graciously devoted their time (and patience) to us. There was no requirement that any managers talk with us for purposes of this project—participation was entirely voluntary—but without exception the people we needed to talk to for the project took time from very busy schedules to meet with us and provide information and understanding of broadband networking in Florida. We gained a deep appreciation for the true expertise and dedication the agency managers have for their agency and mission.

Bill Price, Broadband Program Manager at the Division of Telecommunications (DivTel) in DMS developed a crucial, detailed understanding of broadband in Florida in the time period leading up to this project. He used that understanding to develop awareness of broadband trends and opportunities at all levels, and led the effort to obtain funds for targeted broadband activities for government in Florida. He provided to us at the beginning of the project the vast amount of information he had already collected on broadband, and provided a continuous stream of additional information over the course of the project. His generosity with his time and knowledge was invaluable.

This project could not have succeeded without the strong and continuous support provided by DivTel management, who supported us in our goal of providing an objective and unbiased study of government broadband in Florida. A wealth of institutional knowledge and expertise was given to us by Charles Ghini, Michael Kyvik, Kevin Langston, Ed Peters, Jessica West, Nick Platt, Bill Smith and others over the course of this project. Transition from prior networking and implementation of the outsourced *MyFloridaNet* is relatively recent, and the DivTel team shared many insights and plans with us.

Phil Halstead, Veronica Sarjeant and David Pokorney shared their time and knowledge of *Florida LambdaRail* (FLR) operations with us, as well as general knowledge of national trends regarding research and education networks. The information and understanding they provided was essential for this project due to the importance of FLR to broadband networking in Florida. We greatly appreciate the willingness shown by Lex Thomas of GeoPlan at the University of Florida to understand the network data we obtained from cooperating entities.

Elizabeth Birriel, Randy Pierce, and Frank Deasy manage a third set of communications assets in the Intelligent Transportation System (ITS) program at Florida Department of Transportation. Elizabeth, Randy and Frank generously shared their time and knowledge of ITS with us, explaining the overall ITS system and providing detailed mapping information showing ITS

communications facilities in Florida.

David Taylor at Agency for Enterprise Information Technology was generous in sharing his time and insights regarding technology practices in Florida, technology trends, and his experience with Information and Communications Technology (ICT) in Florida.

Many ICT managers at the city and county level supported our study with their time and information regarding the networks they operate in their jurisdictions. Over 100 city and county managers provided information about their broadband networking infrastructure and approaches through two surveys conducted to support this project. Additional substantial support and knowledge was provided by Ted Kellerman at Gainesville Regional Utilities, Steve Bordelon and Mike Butler of Palm Beach County, Kevin Kryzda of Martin County, Chuck Spalding of Palm Beach Broadband, John Honker of Magellan Advisors, and Don Landin of Fort Pierce Utility Authority.

The North Florida Broadband Authority (NFBA) and Florida Rural Broadband Alliance (FRBA) came into being as our project was beginning. Jeff Hendry of the Florida Institute of Government at Florida State University and Pat Lien of NFBA/FRBA were instrumental in explaining the objectives and network design and planning for NFBA and FRBA.

Judith Ring, Loretta Flowers, Mark Flynn, Jill Canono and Amy Johnson brought us up to date on the work that is being done to support broadband access in public libraries throughout Florida and the work that remains to be done to improve that access for public use. Melinda Crowley shared with us the knowledge that was gained through the Hayes e-Government Resources assessment of library broadband technology use. Bridget Duff provided important research and background on E-rate.

We also want to acknowledge the support of numerous people at the Public Utility Research Center, including Rossana Passaniti, who provided project management and proofread the report; Patricia Casey, who completed the bibliography and report formatting; Naronpol Chotset, who provided research on broadband networks and technologies; David Brown and Claudia Bittman, who background research on healthcare and education; John Banko and his team of University of Florida finance students, who provided data and analysis for our financial modeling; and Jessica Chapman and Courtney Owens for their data gathering and reviews.

Any errors or omissions in the report are the responsibilities of the authors.

The authors of this report are David Brevitz of Brevitz Consulting, Topeka, Kansas; Herb Cash, a private consultant from Atlanta, Georgia; Mary Galligan, a private consultant from Topeka, Kansas; and Dr. Lynne Holt, Theodore Kury, and Dr. Mark Jamison, Public Utility Research Center, University of Florida.

Warrington College of Business Administration
Public Utility Research Center

205 Matherly Hall
PO Box 117142
Gainesville, FL 32611-7142
352-392-6148
352-392-7796 FAX
www.purc.ufl.edu

February 28, 2011

Mr. Jonathan D. Yeaton
Division of Telecommunications
Department of Management Services
4030 Espalande Way
Tallahassee, FL 32399-0950

Dear Mr. Yeaton:

I am providing this report, *Strategic Planning for Florida Governmental Broadband Capabilities*, in accordance with contract 09/10-074 between the Florida Department of Management Services and the University of Florida.

Please feel free to contact me if there are any comments or questions.

Best regards,



Mark A. Jamison, Ph.D.
Director, Public Utility Research Center
University of Florida

cc Bill Price, DMS
Charles Gini, DMS
Brian Prindle, UF

Table of Contents

Acknowledgements.....	iii
Transmittal Letter.....	v
Table of Contents.....	vi
List of Tables.....	xv
List of Figures.....	xvii

Volume 1

1 Introduction.....	1
2 Background, Findings, and Options.....	7
2.1 Why is This Report Important?.....	7
2.2 Findings, Observations, and Recommendations.....	8
2.2.1 Planning and Governance.....	8
2.2.2 Scope of the Enterprise Network Strategic Plan.....	11
2.2.3 Broadband Services – Self-Provisioning and Outsourcing.....	12
2.2.4 Centralization and Decentralization of Network Procurement and Provisioning... 13	
2.2.4.1 Local Government Innovation.....	13
2.2.4.2 Government Barriers to Leveraging Resources.....	14
2.2.4.3 Competitive Access.....	14
2.2.5 Maintenance of Statewide Broadband Maps.....	15
2.2.6 Flexibility and Innovation.....	15
2.2.7 Performance Monitoring.....	16
2.2.8 Federal E-Rate Funding for Schools and Libraries.....	17
3 Report Methodology.....	19
3.1 Qualitative Method.....	19
3.1.1 Literature Review.....	19
3.1.2 Interviews.....	19
3.1.3 Meetings.....	20
3.2 Quantitative Method.....	20

3.2.1	Broadband Utilization Analysis	20
3.2.2	Mapping	20
3.2.3	Financial Modeling	21
4	Broadband Trends	22
4.1	National and International Trends.....	22
4.2	Fiber Deployment for Access.....	22
4.3	Fiber Deployment for Transport	23
4.4	Mobile Broadband.....	24
4.5	Challenges	25
4.6	Broadband Trend Implications for Florida.....	26
5	Drivers for Government Agency and Anchor Institution Use of Broadband Technology	29
5.1	Education.....	29
5.2	Law Enforcement	31
5.3	Health Care.....	32
5.4	E-government – Residential Users.....	33
5.5	E-government – Business Users.....	34
5.6	E-government Applications.....	35
5.6.1	Interactive Video.....	35
5.6.2	Online Records and Transactions	37
5.7	Public Safety Interoperable Systems.....	37
5.8	Productivity Enhancement	38
5.9	Telecommuting.....	38
5.10	Local Government Needs.....	39
6	Florida’s Legal Framework.....	41
6.1	Florida Communication Information Technology Services Act	41
6.1.1	Use of State SUNCOM Network by Municipalities.....	42
6.1.2	Use of State SUNCOM Network by Nonprofit Corporations	43
6.1.3	Use of SUNCOM Network by Libraries	43
6.1.4	State Agency Law Enforcement Radio System and Interoperability Network	43
7	Description of Florida’s State Broadband Networks	44

7.1	MyFloridaNet (MFN).....	44
7.2	Florida LambdaRail (FLR).....	45
7.3	Department of Transportation’s Intelligent Transportation System (ITS).....	47
7.3.1	ITS Networking	48
7.3.2	“Highway Purposes” Policy Requirement and Implications	48
7.4	Barriers for State Agencies	50
7.5	Barriers for Health Care	51
8	Florida Local Government Networks	54
8.1	Florida Law Impacting Municipal Networks	54
8.1.1	Article VIII, Section 2(b), of the Florida Constitution	54
8.2	Description of Local and Regional Networks	55
8.2.1	Gainesville Regional Utilities/GRUCom.....	56
8.2.2	Palm Beach County.....	57
8.2.3	Applications	57
8.2.4	Cost-sharing Arrangements	57
8.3	Opportunities for Collaboration with Local Authorities	59
8.4	ARRA Broadband Technology Opportunities Program (BTOP)	61
8.5	Barriers to Local Use of Broadband.....	61
9	Governance and Planning	64
9.1	State Enterprise IT Governance	64
9.2	Florida IT Governance	66
9.2.1	Agency for Enterprise Technology (AEIT)	67
9.2.2	Technology Review Workgroup.....	69
9.2.3	Department of Management Services (DMS).....	70
10	E-Rate Funding	71
11	Financial Modeling to Assess Options for Delivery Models.....	79
11.1	Scenarios	81
11.1.1	Scenario 1: Present Method of Operation (PMO).....	81
11.1.2	Scenario 2: Leveraging Dark Fiber with Continued Premium Service	81
11.1.3	Scenario 3: Leveraging Dark Fiber with Increased Client Service Options.....	81

11.1.4	Scenario 4: Insourcing Market-priced Dark Fiber	81
11.1.5	Scenario 5: Traffic Aggregation	82
11.2	Modeling Approach.....	82
11.2.1	Probabilistic Modeling.....	82
11.2.2	Top-Down.....	82
11.3	Cost Impacts of Delivery Model	82
11.4	Financial Modeling Results.....	83
12	Conclusion	86
12.1	Section 1: Goals and Objectives.....	86
12.2	Section 2: Service Delivery Models.....	86
12.3	Section 3: Collaboration and Centralization	86
12.4	Section 4: Performance Assessment	86
12.5	Section 5: Governance	86

Volume 2

13	Financial Modeling for This Report	89
13.1	Modeling Approach.....	91
13.1.1	Probabilistic Modeling.....	91
13.1.2	Bottom-Up versus Top-Down.....	92
13.2	Policy Scenarios	93
13.3	Impacts of Ownership on Costs	95
13.3.1	Agency Problems	96
13.3.2	Objectives	96
13.3.3	Expropriation	97
13.3.4	Cost of Money.....	98
13.4	Outputs	100
13.5	Data Sources.....	102
13.6	Estimating Total Cost.....	103
13.7	Scenarios	109

13.7.1	Scenario 1: Present Method of Operation (PMO).....	109
13.7.2	Scenario 2: Leveraging Dark Fiber with Continued Premium Service	109
13.7.3	Scenario 3: Leveraging Dark Fiber with Increased Client Service Options.....	109
13.7.4	Scenario 4: Insourcing Market-priced Dark Fiber	109
13.7.5	Scenario 5: Traffic Aggregation	109
13.8	Explanations of Each Scenario’s Algorithms.....	110
13.8.1	Algorithms for Scenario 1: Present Method of Operation.....	110
13.8.2	Algorithms for Scenario 2: Leveraging Dark Fiber with Continued Premium Service	112
13.8.3	Scenario 3: Leveraging Dark Fiber with Increased Client Service Options.....	117
13.8.4	Scenario 4: Insourcing Market-priced Dark Fiber	118
13.8.5	Scenario 5: Traffic Aggregation	119
13.9	Modeling Results.....	120
13.9.1	Summary of Findings.....	120
13.9.2	State Agencies.....	121
13.9.3	Education	123
13.9.4	Local Governments.....	124
14	Statewide Florida Broadband Networks and Services for Government Use.....	126
14.1	Florida Law	126
14.2	Florida Communication Information Technology Services Act	126
14.2.1	DMS Powers and Duties.....	127
14.2.2	Exemptions from the Required Use SUNCOM Network.....	128
14.2.3	Use of State SUNCOM Network by Municipalities.....	129
14.2.4	Use of State SUNCOM Network by Nonprofit Corporations	129
14.2.5	Use of SUNCOM Network by Libraries	130
14.3	The MyFloridaNet (MFN)	130
14.3.1	Funding of MFN	131
14.3.2	MFN Features and Benefits	132
14.3.3	MFN Before and After the Contract Extension	133
14.3.4	MFN Competitive Access.....	133

14.3.5	Remote Broadband Service and MFN Access.....	135
14.3.6	MFN Contract Renewal and Extension	136
14.3.7	Mobile Broadband	141
14.3.7.1	AirCard Service	141
14.3.7.2	Mobile Communication Services Procurement.....	141
14.3.7.3	Additional Broadband Options.....	143
14.4	Florida Lambda Rail (FLR).....	143
14.4.1	FLR Funding and Membership.....	143
14.4.2	FLR Network	145
14.4.3	FLR Operations and Services	147
14.4.4	Geographic Extent of Florida LambdaRail Network.....	148
14.4.5	Interconnection Between MFN and FLR.....	149
14.5	Florida Department of Transportation’s Intelligent Transportation System.....	151
14.5.1	ITS in Florida.....	151
14.5.2	ITS Networking	153
14.5.3	“Highway Purposes” Policy Requirement and Implications	154
14.6	New Networks Funded by American Recovery and Reinvestment Act	157
14.6.1	North Florida Broadband Authority (NFBA) and Florida Rural Broadband Alliance (FRBA)	157
15	Networks Operated by Florida Local Units of Government.....	159
15.1	Florida Law Impacting Municipal Networks.....	159
15.1.1	Municipal Home Rule.....	159
15.1.2	Provision of Telecommunications Services by Municipalities or Other Entities of Local Government.....	160
15.1.3	Procedures and Operating Conditions for Governmental Entities Providing Cable or Telecommunications Services.....	160
15.2	Summary of Findings.....	162
15.3	Summary of City and County Broadband Networking.....	162
15.4	South Florida Shared Fiber Initiative (SFSFI).....	164
16	Comparison of State Networks	166
16.1	Scope and Role of Networks.....	167

16.2	Evolution of Networks	169
16.3	Outsourcing or State Ownership and Operation	175
16.4	Availability of Services to Local Units of Government.....	176
16.5	Administration and Operation of Networks -- General Overview.....	178
16.6	Administration and Operation of Networks -- Performance and Accountability	180
16.7	Administration and Operation of Networks – Financing.....	182
17	Higher Education Networks.....	186
17.1	The National Context	186
17.2	Higher Education State Strategic Plans.....	188
17.3	Organizational Structure	189
17.4	Characteristics of Higher Education Networks	190
17.4.1	Availability of Dark Fiber.....	190
17.4.2	Collaboration.....	191
17.4.3	Saving Money	193
18	K-12 and Public Library Networks.....	195
18.1	Overview	195
18.2	Public School Networks.....	197
18.3	Public Library Networks	202
18.3.1	Florida’s Public Libraries	203
18.3.2	Provision of Information Resources Using Broadband Technology in Florida ...	203
18.4	Broadband Purchasing for K-12 Schools and Public Libraries.....	206
18.4.1	Federal Funding for Broadband in Schools and Libraries	208
19	Public Safety	214
19.1	Florida Communication Information Technology Services Act	214
19.1.1	DMS Responsibility for State Agency Law Enforcement Radio System and Interoperability Network	214
19.2	Public Safety Networks.....	215
19.2.1	Introduction.....	215
19.2.2	Narrowband Voice Systems.....	215
19.2.2.1	Interoperability	216

19.2.2.2	Statewide Law Enforcement Radio System (SLERS).....	217
19.2.3	Broadband Networks	217
19.2.3.1	Criminal Justice Network (CJNet)	217
19.2.3.2	Mobile Broadband in Florida	219
19.2.3.3	Nationwide Interoperable Public Safety Wireless Network.....	219
19.2.3.4	DMS Waiver Request.....	221
19.2.3.5	Development of Nationwide Interoperable Public Safety Wireless Networks using Commercial Partners	223
19.2.3.6	Public Safety Network Governance	224
19.3	Public Safety Networks in Other States	227
19.4	Next Generation E911 Systems in Florida.....	229
19.4.1	Background for NG-911 Statewide Routing Development.....	230
19.4.2	Overview of Desired NG-911 Statewide Routing Development.....	231
19.5	Financing Public Safety Networks.....	233
20	Governance and Planning, Centralization and Shared Services	236
20.1	Governance and Planning.....	236
20.2	Consolidation and Shared Services	237
20.3	Agency for Enterprise Information Technology	238
20.4	Technology Review Workgroup	243
20.5	Department of Management Services	243
21	American Recovery and Reinvestment Act (ARRA).....	250
22	Participants: Service Provider Forum	255
23	Appendix I: Summary of the 2009 DMS Local Broadband Inventory Survey and 2010 Magellan Advisors Local Broadband Inventory Survey	256
24	Appendix II: Magellan Advisors “Local Government Communications Use and Municipal Broadband Development,” December 18, 2010.	268
25	Appendix III: Gainesville Regional Utilities/GRUCom.....	277
26	Appendix IV: MFN Critical Applications and TRW Schedule IV-C, Agency Impacts of Downtime.....	281
27	Appendix V: Florida Network Technical Attributes	289
28	Appendix VI: Health Information Technology.....	296

28.1	Introduction	296
28.2	Benefits of HIT.....	297
28.2.1	Preventive Care.....	297
28.2.2	Chronic Disease Management	298
28.2.3	Care Coordination.....	299
28.2.4	Medication Management	300
28.2.5	Emergency Medical (Health) Records.....	301
28.3	Broadband Requirements	301
28.3.1	Hospital Characteristics	303
28.3.2	Value-Based Payment Systems.....	303
28.3.3	Rural Broadband Access.....	304
28.4	Florida Health IT	306
28.5	Conclusion.....	308
29	Appendix VII: Technical Comparison of State Networks.....	310
30	Appendix VIII: Comparison States’ Pricing Network Service Information.....	319
30.1	Illinois.....	320
30.2	New York.....	322
31	Bibliography	325

List of Tables

Volume 1

Table 7-1.	WellFlorida Council Survey of Internet Access, 2010	52
Table 8-1.	Magellan Advisors Barriers to Local Government Broadband Development.....	62
Table 9-1.	Common Arrangements of Governance Authority Patterns.....	66
Table 10-1.	Comparison of E-Rate Performance for Florida and Comparator States, 1998- 2009	77
Table 11-1.	Total Fiscal Year Broadband Expenditures by Major State Broadband Suppliers in Florida, 2006-2010	79
Table 11-2.	Total Fiscal Year Broadband Billings by DMS to State Government Customers, 2006-2010.....	80
Table 11-3.	Scenario Results for Entities Purchasing MFN and GMAN	84

Volume 2

Table 13-1.	Estimate of Cost of Capital for Private Operator.....	101
Table 13-2.	Estimate of Florida LambdaRail Cost of Service	105
Table 13-3.	Estimated Costs for GRUCom, 2009.....	106
Table 13-4.	Estimate of Projected Broadband Costs for Local Governments in Florida.....	108
Table 13-5.	Income Sources for FLR, 2008-2009.....	111
Table 13-6.	Estimate of AT&T's Broadband Costs	115
Table 13-7.	Five-year State Agency Costs by Scenario.....	122
Table 13-8.	Five-year MFN College Costs by Scenario	125
Table 14-1.	Effect of Rate Reductions from MFN Contract Extension.....	138
Table 14-2.	FDOT ITS Existing and Programmed Fiber Strand Miles, 2010	154
Table 18-1.	Comparison of Pricing from Agency Procurement versus Enterprise Procurement.....	199
Table 18-2.	Comparison of Pricing for Select Bandwidth Levels, DOE and DMS Procurements	200
Table 18-3.	Florida ARRA Projects for Schools and Libraries	210
Table 18-4.	New York ARRA Projects for Schools and Libraries	210
Table 18-5.	Ohio ARRA Projects for Schools and Libraries	211
Table 18-6.	Pennsylvania ARRA Projects for Schools and Libraries.....	211
Table 18-7.	Illinois ARRA Projects for Schools and Libraries.....	212
Table 19-1.	Comparison of E911 and NG-911	230
Table 23-1.	Cities Responding to 2009 and 2010 Surveys	258
Table 23-2.	Counties Responding to 2009 and 2010 Surveys	261
Table 25-1.	GRU and GRU.COM Financial Information.....	280
Table 26-1.	Agency Impacts of Downtime	284

List of Tables (continued)

Table 27-1. Florida Network Technical Attributes	289
Table 30-1. Cost Recovery Data FY 2008-2009	320
Table 30-2. Summary of Rates for IT Shared Services.....	322

List of Figures

Volume 1

Figure 4-1. Global Fixed & Mobile Broadband Subscribers, 2003-2009	25
Figure 5-1. Frequency of Use of State of Florida Government Websites by Interconnected Florida Businesses in 2010.....	36
Figure 8-1. Overlay of MFN Locations on Palm Beach County Fiber Optic Networking	60

Volume 2

Figure 13-1. Scenario Modeling Results for State Agencies.....	123
Figure 13-2. Scenario Modeling Results for MFN Sales to Colleges and Universities	125
Figure 14-1. MFN Prior to Contract Extension.....	134
Figure 14-2. MFN After Contract Extension.....	135
Figure 14-3. Wireless IP Cloud Interconnection to MFN	144
Figure 14-4. Florida LambdaRail Network Map.....	148
Figure 14-5. FLR/MFN Interconnection View.....	149
Figure 16-1. MFN Served Locations	171
Figure 19-1. NG-911 Network Using MFN	232
Figure 29-1. Technical Comparison of State Networks	310

Volume 1

1 Introduction

In 2009 the Florida Legislature declared that

The Legislature finds that broadband Internet service is critical to the economic development of the state and is beneficial for libraries, schools, colleges and universities, health care providers, and community organizations. The Legislature further finds that barriers exist to the statewide deployment of broadband Internet service, especially in rural, unserved, or underserved communities. The Legislature therefore intends to promote the efficient and effective deployment of broadband Internet service throughout the state through a coordinated statewide effort.¹

As in other states, Florida has an agency assigned to aggregating state agency telecommunication demand and arranging for procurement of services to meet projected demand. In Florida, the agency charged with that responsibility is the Department of Management Services (DMS) which procures and manages various telecommunication services on an enterprise basis for Florida's state government agencies, local units of government and certain non-profit organizations.² Provisioning of broadband Internet services in a cost-effective manner moves toward the goal of widespread deployment of broadband services for public entities, as articulated in state and federal law.

Section 364.0135(1) of the Florida Statutes seeks to encourage efficient and effective deployment of broadband Internet services, including development of a strategy to ensure the commitment of public and private anchor institutions to fostering investment in broadband infrastructure aided by stimulus funds. This policy was expected to lead to enhanced broadband resource access for institutions and citizens and greater participation in employment and economic development opportunities that broadband services present.³ The law assigned DMS to

¹ Section 364.0135(1), Florida Statutes.

² It is the Division of Telecommunications or DivTel within DMS that has been responsible for providing state telecommunications services, but for convenience and to avoid confusion due to extensive statutory and other references to DMS, "DMS" is generally used in this report rather than "DivTel."

³ By intention we do not adopt a specific technical definition of "broadband" in this report. "Broadband" means different things to different people in different contexts. The primary meaning of "Broadband" in this report refers to a high speed data transport service used by government entities on a "wide area networking" basis as exemplified by MyFloridaNet (MFN). "Broadband" encompasses government use of online applications, the Internet, data communications and the "web."

coordinate the statewide effort.⁴

As permitted by Section 364.0135 of the Florida Statutes, DMS applied for and was awarded funding from the U.S. Department of Commerce’s National Telecommunications Information Administration (NTIA) under the American Recovery and Reinvestment Act (ARRA) to engage in broadband planning and mapping to support broadband use by Florida’s anchor institutions and state and local governments. A first step in the planning effort involves an analysis of the existing broadband networks and their capacities, use and procurement practices for broadband by Florida’s anchor institutions. To take that first step, DMS commissioned this broadband planning study by the Public Utility Research Center (PURC) at the University of Florida to research government networks, services, and infrastructure in Florida today, to research technology trends and current and future government broadband needs, to analyze and assess current government approaches to obtaining broadband capacity and the results of those approaches, and to provide the basis for observations about ways in which the state can most cost-effectively facilitate the Legislature’s intent, quoted above, for broadband availability for certain “anchor institutions.”⁵

In addition to using federal funds to develop a broadband planning report, Florida received federal funding as awarded to DMS to collect data with which to develop a map of broadband services availability in the state, and supplemental funding to establish a “Broadband Program Office” that will continue the mapping project; manage the development and implementation of regional broadband planning teams; establish a Florida E-rate team; establish a broadband grant team; and conduct further assessment of Florida public library broadband infrastructure.⁶

Unlike many other states, Florida currently has no overall statewide strategic plan to guide actions for obtaining and using broadband services across all state agencies as well as cities and county governments. Through its own preliminary research, which was confirmed by our research, DMS found that many local units of government and state agencies have and are continuing to direct their own investments in broadband infrastructure and services:

Within the State of Florida, there are numerous autonomous state and local government networks independent of a strategic plan. We believe these

⁴ Department of Management Services, *Request for Quotes, State Broadband Planning Initiative*.

⁵ For purposes of the State Broadband Data and Development Grant Program, the U.S. Department of Commerce, National Telecommunications and Information Administration used a definition of Community Anchor Institution that is similar, but not identical to, the list of entities described in the Florida statute quoted above: “III. Definitions: *Community Anchor Institutions*. Schools, libraries, medical and healthcare providers, public safety entities, community colleges and other institutions of higher education, and other community support organizations and entities.” National Telecommunications and Information Administration, “State Broadband Data and Development Grant Program,” 32545.

⁶ Department of Management Services, *Division of Telecommunications Business Model*, 11-12.

independent networks are not fully leveraged to achieve the greatest economies of scale for the benefit of Florida anchor institutions and citizens. For example, Florida’s Department of Transportation (FDOT) operates a statewide fiber and microwave network in support of Intelligent Transportation Systems applications (ITS) that has been funded in part through the Department of Highway Administration since 1993. The state universities operate Florida LambdaRail, established to provide broadband services including Internet2 and commercial telecommunications services as well.⁷

The preliminary DMS research also suggested that those investments in broadband infrastructure have not been based on a statewide strategy that is comprehensive, collaborative and targeted toward maximizing benefits from taxpayer investments. This view holds that development of an overarching vision for obtaining broadband has been lacking, resulting in fragmentation and lost economies of scale. An alternative viewpoint is that decentralized decision-making enables more localized initiative and innovation, the value of which local decision-makers can balance against foregone scale economies if such economies exist.

Regardless of the vision adopted, questions that arise from that preliminary conclusion by DMS include:

- Given fiscal exigencies and pressures, would a more centralized approach to purchasing, managing and providing broadband services be more cost-effective than the present method of operation?
- Alternatively, is a more decentralized procurement approach able to realize better results?
- Can practices of other states point to different ways of pricing and procuring services through insourcing, outsourcing, or a hybrid approach, determining agency needs, providing incentives to agencies for cost containment, and strengthening coordination among agencies and government entities to aggregate demand for new services?

A DMS goal for this study was to determine the current government broadband supply, demand, cost and modes of operations. The Request for Quotes and the resulting contract with PURC stated that this research should identify strategic options for government leadership to consider as a means of maximizing benefits from governmental expenditures for broadband. More specifically, the deliverables for this project included:

1. An assessment of Florida government broadband infrastructure and service offerings, including a historical review of SUNCOM,⁸ Florida Department of Transportation

⁷ Department of Management Services, *Request for Quotes, State Broadband Planning Initiative*.

⁸ SUNCOM is the state enterprise telecommunications system. We further describe SUNCOM in Section 6.

(FDOT) and Florida LambdaRail (FLR)⁹ networks and services; an assessment of local government broadband networking activities; a comparison of broadband systems for states of similar size to Florida and their trends for increasing broadband availability and adoption; descriptions of technology and industry trends; technical descriptions of current networks; and an examination of what will impact government broadband communications in the next three to five years;

2. A description and analysis of current government insourcing and outsourcing models for providing broadband services, including identification, analysis, and evaluation of:
 - Current government broadband contracts, costs, and service pricing and how they might be optimized;
 - Current broadband network services, technologies and operations used by government;
 - Current government organization and governance of broadband operations; and
 - Potential financial impacts of broadband service delivery for governmental entities through privatization (outsourcing) versus build, own and operate (insourcing), as well as recommendations for ways in which the state can best meet the current and future broadband needs of government;
3. Review and evaluation of current and future government broadband requirements and development of strategies for satisfying them effectively and efficiently, including an analysis of current and future government broadband plans, uses and projected needs, gaps and possible solution options with recommendations, with particular focus on public safety, healthcare and education;
4. Identification of current broadband availability and adoption barriers to government in Florida as well as current disparities and drivers in broadband adoption by government; and
5. A broadband strategy planning report that provides options and recommendations for how government in Florida can optimize broadband utilization, including how Florida can leverage current assets and resources to maximize broadband service availability at the lowest cost.

In the context of these deliverables, this report provides information useful for planning efforts that can be used if policymakers conclude a Strategic Broadband Plan should be developed. Obviously, options presented in this report are not the only ones available to policymakers. We

⁹ FLR is the statewide research and education network in Florida. We further describe FLR in Section 7.2.

anticipated that other courses of action will be considered during future policy discussions.

An examination of options is timely because trends in technology and applications, federal policies and funding have transformed the landscape for broadband deployment. Federal broadband policies emphasize the importance of broadband access for, and utilization by, governmental entities and community anchor institutions. Availability of federal stimulus moneys has caused new collaborative relationships to be forged between broadband providers and anchor institutions to provide broadband access to communities and institutions across the country. Although it remains to be seen whether these arrangements will be financially viable without additional taxpayer subsidies, these partnerships and the increasingly broadband capacity-intensive nature of applications used by anchor institutions (due to increasing presence of graphic and image data versus the previous predominance of text files) present both new opportunities and challenges for state and local government agencies and organizations in Florida. These opportunities and challenges, in turn, may ultimately affect the nature of anchor institutions' demand for broadband services.

State and local government revenue pressures also make it timely to examine the networks and services used by Florida's governmental entities and related infrastructure in Florida today, as well as current and future government broadband needs. Related to that examination are the broadband procurement practices and governance structures here and in other states, including results of those approaches in Florida and options for improvement. This report summarizes the results of our research.

The existence of freestanding networks and the lack of an overarching strategic plan may raise concerns in people's minds about cost-effectiveness and the ability of state and local units of government to act in concert to optimize utilization of available assets. While state and federal policymakers have emphasized the importance of planning for broadband procurement and deployment, absent careful construction, a poorly designed plan could inefficiently restrict individual governmental entities that are likely to know more about their needs than might any centralized planning entity. We provide examples of innovative local government practices for obtaining broadband in Gainesville and Palm Beach County (others are evident in the Local Broadband Infrastructure Survey in Vol. II SD Appendix I). In addition to those jurisdictions, we describe the efforts of the North Florida Broadband Authority (NFBA) and the Florida Rural Broadband Alliance (FRBA) that were awarded \$54 million in ARRA grants to build regional broadband networks in Florida's Rural Areas of Critical Economic Concern (RACECs). These networks illustrate the rapidly developing nature of the broadband environment in Florida.¹⁰

¹⁰ The NFBA and FRBA initiatives are described in Volume II Supporting Documents Section 14.6, but briefly since both are in the formative, planning and procurement stages as this Report is being written. Citations to Volume II are hereafter referred to as Vol. II SD Sec.

Our findings and recommendations are intended to provide options for, and a basis for, strategic planning for state and local government broadband in Florida. Our work emphasizes the following features of such a plan:

Element 1. Goals and Objectives: What should be the outcomes of implementing a strategic plan?

Florida's purposes for a strategic plan are spelled out in legislation and DMS documents. Rather than develop new goals and objectives, we rely upon existing sources to inform our research and recommendations.

Element 2. Delivery Model: How should governmental entities obtain broadband services?

We analyze options for insourcing, outsourcing, and infrastructure-sharing to obtain broadband services.

Element 3. Collaboration: How should governmental entities collaborate to maximize the benefits to Floridians in the ways in which these entities obtain broadband?

We identify potential gaps in, and barriers to, current collaborative efforts that appear to hinder cost-effectiveness or sharing opportunities to increase utilization of existing assets and success in obtaining outside funding. We identify ways to improve collaboration while facilitating innovation.

Element 4. Performance Assessment: How should policymakers evaluate the effectiveness of implementation of a strategic plan if one is ultimately developed and adopted?

We identify studies and reviews that should be undertaken periodically to assess whether actions taken to implement the strategic plan meet the plan's goals and objectives, and that will provide data that will inform plan updates and revisions.

Element 5. Governance: Who should have authority to make decisions regarding broadband planning and implementation, and how should these decision-makers be held accountable?

We identify an institutional structure for decision-making and accountability.

2 Background, Findings, and Options

2.1 Why is This Report Important?

Broadband service has transformed and continues to transform how governments operate and how citizens interact with government. In this context, reviewing and updating policies for the delivery of broadband services to government agencies and anchor institutions in Florida is important to the state for a number of reasons: Technology and industry changes, and agency actions and program implementations have created alternatives for supplying broadband. Experiences from other states point to viable options to Florida’s current approach for obtaining broadband. A resurgent debate over who should provide broadband to governmental entities and the role of individual choice by state agencies indicates that there is a meaningful disagreement among informed stakeholders as to the proper path forward. A variety of applications using broadband capacity, such as utilizing centralized data centers, uploading Geographic Information Systems (GIS) files, backing up data files and providing for disaster recovery, and increasing use of graphical and image-based data—“multimedia”—over the traditional plain text files associated with computer systems are important to Florida’s residents and place increasing demands on broadband infrastructure. Critical applications are delivered using broadband infrastructure, such as the state’s MyFloridaNet (or MFN), which is provided by DMS for statewide connectivity to enterprise applications as well as public access to all state services, such as the Florida Crime Information Center, Florida Driver License Information System, and Florida Unemployment Internet Claims.¹¹ Additional critical applications¹² supported by MFN are listed in Vol. II SD Appendix IV.¹³ These and other applications appear to justify the effort necessary to produce a workable and cost-effective broadband planning process and methods for obtaining broadband for Florida’s public sector. This report is intended to be directional in nature, and provide information to support more detailed broadband planning by the State of Florida and Florida’s local units of government.

Notably, this report is not intended to address consumer broadband issues. Rather, it is focused exclusively on the use of broadband by public entities and organizations in Florida. DMS described three different state networks, and the differing approaches of insourcing vs. outsourcing of broadband networks in Florida. DMS specifically asked us to examine the networks operated by DMS (MFN, which is largely outsourced), FLR (whose core facilities are outsourced, but otherwise the network is insourced)¹⁴ and FDOT’s Intelligent Transportation

¹¹ Ghini, *Renewal versus Rebid of the MyFloridaNet Contract*, 1.

¹² Ibid at Attachment 14. Attachment 14 contains a list of additional critical applications that run on MFN that is reproduced in Vol. II SD Appendix IV.

¹³ The impact of downtime on an agency can also be considered by reference to Vol. SD Appendix IV, which shows “exceeded downtime impact” from TRW reporting.

¹⁴ In general, we refer to FLR as insourced.

System (ITS) facilities, which have been constructed by contractors but are operated by the FDOT districts. DMS also asked us to research and consider broadband networking used and operated by cities and counties. Finally, DMS asked us to consider and examine results and differences associated with insourcing versus outsourcing as a means of obtaining broadband for government use in Florida.

2.2 Findings, Observations, and Recommendations

Our findings, observations and recommendations are presented here with options for action. This report is oriented to provide information and options that can be useful for further planning activity should state policymakers choose to address strategic broadband planning across state and local governments. We therefore focus more on providing foundational information, findings and observations rather than recommendations.

We do not draw conclusions about the ways in which our recommendations should impact overall resource allocation for the state government. One response by policymakers to our findings and recommendations could be to simply add some or all of these recommendations to the workloads of existing governmental organizations. This would likely lead agency managers to make decisions about which duties their respective agencies should do forego in order to adopt the new responsibilities. Another response by policymakers would be to reset priorities, giving government managers clear direction by either describing priorities or by explicitly decreasing responsibilities that compete for resources with broadband planning. A third response could be to increase governmental budgets to pay for the additional activity. Recognizing that budgets are tight in today's economy, we believe that policymakers should provide clear direction to managers so that the tradeoffs they make reflect the considered desires of policymakers.

2.2.1 Planning and Governance

Our research found no strong opposition among state agencies to the idea of centralized broadband planning, but we did find a diversity of opinions as to what centralization should mean. Governmental entities that are not currently required to purchase network services from DMS did not express a desire for expanded centralization of broadband purchasing.

We distinguish three levels of planning. At the highest level is a strategic plan for governmental entities in Florida with respect to information technologies (IT) and communications technologies (or collectively "ICT"¹⁵) that includes broadband. This strategic plan, should one be developed and adopted, should cover goals and objectives, delivery models, collaboration and

¹⁵ "ICT" or "Information and Communications Technologies" is the term commonly used worldwide to reflect the growing integration of IT and communications technologies. ICT is also characterized by convergence trends including the convergence of voice and data networking. See also, Department of Management Services, *Division of Telecommunications Business Model*, 45-50.

centralization, performance assessment, and governance.¹⁶ The next highest level of planning would be enterprise planning, which should encompass strategies and opportunities to improve the delivery of cost-effective and efficient IT and broadband services at the enterprise level, based upon the overall strategic plan. The third level is at the procurement or delivery level, where entities responsible for obtaining or providing broadband develop plans for ways in which to perform their functions, given the enterprise level plan.

We find that governmental entities in Florida have engaged in planning. For example, DMS develops plans for SUNCOM and the City of Gainesville develops plans for its city-owned broadband provider, GRUCom. However, a deliberate enterprise-level plan for broadband has been lacking at the state level. We also find that the state has not developed an overall strategic ICT plan for governmental entities.

Florida is pursuing grant funding for broadband without an overall strategic plan to guide that pursuit. Other states use their strategic plans to guide their grant-seeking efforts, which appears to increase their chances of success.

In our research, we encountered several instances where governmental entities were reluctant to share network, cost, service, and contract information. Such lack of transparency, if it were to permeate the planning processes we recommend, would frustrate state objectives for economic efficiency and effectiveness.

Our research revealed that proper governance for planning and implementation is a critical factor for effective and efficient enterprise service deployment. Florida's statutory governance structure for enterprise technology includes key features that should lead to success. Those features include the location of the Agency for Enterprise Information Technology (AEIT) at the highest level of the state enterprise, the functional separation of IT operation from the planning and accountability functions, and the distinction between enterprise and agency IT functions.

In our view, organizational convergence should parallel the ongoing trend for ICT convergence (e.g., integration of communications and IT technologies; convergence in voice/data transmission technologies; mobile and fixed broadband capacity). We elaborate further about this in our second recommendation.

Having enterprise strategic planning responsibility for the data network¹⁷ in a statutorily

¹⁶ Of course, a governance structure must be in place for a strategic plan to be developed, but the plan should describe authority and accountability for carrying out the strategic plan.

¹⁷ DMS and others we interviewed use the terms data network or data transport to characterize MFN. See for example http://dms.myflorida.com/suncom/suncom_products_and_pricing/data_transport_services, accessed February 19, 2011. We adopt this terminology, but note that broadband networks such as MFN can and do carry voice and video services as well as data.

designated planning entity should provide efficiencies, clearer lines of communication, and an increased probability of successful implementation of enterprise service plans in the future. AEIT is that planning authority for enterprise IT in Florida and perhaps for enterprise communications networking as well, although we found disagreement in our research on whether AEIT is currently authorized to engage in broadband planning. Because of this dispute, if policymakers intend for AEIT or another agency to be the enterprise level planning authority for broadband, it would seem productive to clarify that intent.¹⁸

Such an alignment of responsibilities also should improve overall accountability. Since the current statutory provisions make the Chief Information Officer (CIO) Council an important element of enterprise planning, implementation of this recommendation will require that the DMS Division of Telecommunications (DivTel), which would continue to operate the data network, continue to actively participate in the CIO Council.

Recommendation #1: We recommend a three-fold approach to planning and governance.

1. First, we recommend that the state develop an overall strategic plan for government IT and broadband, considering all state and local governmental entities in Florida. This strategic plan should include explicit requirements for transparency and for information and data sharing among governmental entities and with the planning entities. While we refer most extensively to DMS, FDOT ITS, FLR and local units of government in this report, overall strategic planning should not be restricted to only those entities. Other governmental entities, such as community colleges, and other networks, such as FDOT microwave radio and public safety radio, should also be covered and included in the overall strategic planning process.
2. We further recommend that the designated state entity for enterprise planning should, based on the overall strategic plan, develop enterprise plans for broadband that would cover all of state government. This recommendation is not meant to imply that all state governmental entities should have centralized procurement. Indeed, we recommend that the current procurement model that enables DMS, FLR, and FDOT ITS to each obtain and develop its own services be continued, but we do recommend the removal of barriers to collaboration among these three entities so that they more readily leverage each other's resources. We elaborate on this point in our fourth recommendation.
3. Finally, we recommend that governmental entities responsible for procurement or provisioning of broadband continue their planning function for their individual operations

¹⁸ In our second recommendation, we suggest converging IT and network planning.

in accordance with the overall strategic plan and appropriate enterprise plan.

This recommendation specifically does not include moving operational responsibilities for SUNCOM services from DMS.

Implications of such a governance change include:

- Ensuring that planning for enterprise IT services encompasses the enabling network utility; and
- Streamlining the planning process for network support of enterprise IT services.

2.2.2 Scope of the Enterprise Network Strategic Plan

Organizational convergence should parallel the ongoing trend of ICT convergence, meaning that IT and network planning functions should be conducted together in the statutorily designated planning authority.

Planning for broadband service provision in isolation, independent of overall strategies for utilizing ICT to facilitate business processes, would be inefficient because cost and effectiveness trade-offs across the enterprise cannot be adequately considered without holistic development of communication, computing, and information management and processing plans. For example, data center consolidation has significant implications for networking, due to inherent trade-offs of IT and broadband capacity between the data center alternatives. As another example, development of a strategy for cloud computing that does not address broadband data communications networking could result in failure to reach the ultimate organization-wide cost efficiencies. Furthermore, any significant move from agency data centers to cloud computing will necessitate consideration of how much broadband capacity is required, and where it is required.

We find that state agencies have sought to coordinate planning for IT and broadband, but that a formal framework for convergence planning does not exist, leaving open the possibility that coordination can break down. Indeed we found instances where the absence of supportive communication and cooperation among governmental entities delayed what would appear to be economical sharing of ICT resources. For example, some people we interviewed who were involved in planning and procurement of broadband services or facilities said they found it difficult in some cases to obtain cooperation from entities involved in ITS at both the state and local levels of government.

Recommendation #2: Planning for all elements of ICT should be done comprehensively. We recommend that provision for enterprise broadband strategic plans should be an element of Florida's overall ICT strategic plan that is developed cohesively and comprehensively. We identify the hallmarks of a suitable governance arrangement in our first recommendation.

2.2.3 Broadband Services – Self-Provisioning and Outsourcing

Our analysis found no compelling reason to change the current mix of insourcing and outsourcing for obtaining broadband services. We examined this issue primarily from perspectives of government budgeting, overall taxpayer cost, and innovation. Government budgeting focuses on the cash flows of government entities, namely their revenues from taxes, grants, and the like, and their cash outflows for capital expenditures and operating expenses. The overall taxpayer cost includes the government budget costs, plus considers the taxpayers' opportunity costs of having to pay taxes rather than use money for personal expenses or investment. By "innovation" we mean the opportunities to experiment, customize services to localized situations, and find new opportunities to save costs or improve value.

We find that an insourced government network is unlikely to save taxpayers money. More specifically, we find that even though self-supply by a governmental entity may appear to have lower costs than outsourcing from a government budgeting perspective,¹⁹ the appearance of lower budget costs results from the insourcing option ignoring taxpayers' cost of money. If it is at least as costly from a citizen's perspective of opportunity costs to give up a dollar in taxes to invest in a government-owned network as it is to give up a dollar to invest in a private entity, then insourcing is typically more costly than outsourcing unless the government as an operator is more technically efficient than a private business, or if the government for some reason has access to assets at below market prices (such as might be the case with leveraging existing underutilized dark fiber), or both.²⁰

For example, we project under the current sourcing arrangements that total spend by state agencies that purchase MFN will be about \$186.5 million during the next five years. From a budgeting perspective, if DMS were able to leverage current ITS fiber and serve 10 percent of its client base with that fiber at less than market price (presuming the fiber is underutilized), the five-year projection would decrease only to \$185.1 million. The cost savings is slight and would largely disappear if taxpayer opportunity costs were considered or if DMS had to pay fully compensatory prices for the fiber optics.

We project that FLR's total costs during the next five years will be about \$25.6 million under the present method of operations.

Recommendation #3: We find no reason to change the current policy of outsourcing broadband

¹⁹ Based on our financial modeling, an insourced network would look less costly in a governmental budget as long as the government-owned network was no more than 8.76 percent less technically efficient than a private network. As we explain elsewhere in our report, government-owned enterprises are generally less efficient than private enterprises in terms of operating and capital costs. This is called technical efficiency.

²⁰ We elaborate on the relative efficiencies of government-owned and privately owned enterprises in Vol. II SD Sec. 13.

services for state agencies, or to change the insourcing and outsourcing approaches used by universities, FDOT, and local governmental entities in Florida.

2.2.4 Centralization and Decentralization of Network Procurement and Provisioning

2.2.4.1 Local Government Innovation

We find that Florida’s long-standing policy supporting local home rule expresses itself in a less centralized approach toward network provisioning for internal use by local governments and enables innovation and entrepreneurship.

Extensive local networks have been developed to meet operational needs of local units of government. We find that a great deal of interesting, useful and productive activity is occurring at the local level that should be fostered and encouraged.²¹

In recent years, some of Florida’s municipalities have developed broadband services and networks to respond to community-specific needs. For example, Gainesville Regional Utilities (GRU), the municipal utility owned by the City of Gainesville, partnered with Shands Hospital in Gainesville to construct a fiber ring around the community for high bandwidth communications transport between GRU facilities and between Shands clinics because traditional telephone companies lacked the necessary services.²² In 1996, GRUCom, which is the communications arm of GRU, began to provide commercial service and the utility added high-speed broadband access in 2000. GRUCom also hosts network interconnections for competing private carriers.

Based on those findings, we conclude that centralized control of the ways in which local governments obtain broadband services has the potential risk of reducing innovation and responsiveness by local governments to their agencies’ needs.

Recommendation #4: The state should not make policy changes that would further restrict the current flexibility, and stifle the creativity, of local governmental units. Furthermore the state should ask local governments to make recommendations for state policies, perhaps embodied in an overall state-wide ICT strategic plan, for improving the efficiency with which local governments collaborate and coordinate their efforts to obtain broadband.

²¹ Local Broadband Inventory survey work was done in 2009 and 2010. The 2009 survey was developed and conducted by DMS in summer 2009, in which it surveyed Florida cities and counties regarding broadband network inventory. The 2010 survey was conducted by Magellan Advisors under PURC auspices to update and was designed to extend and update the 2009 DMS survey. The results of these surveys of local units of government are described in a subsequent section and included in Vol. II SD Appendices I and II, to identify the extent and purpose of local authority broadband networking.

²² Vol II SD Appendix III Gainesville Regional Utilities/GRUCom.

2.2.4.2 Government Barriers to Leveraging Resources

Our research revealed that local units of government have deployed extensive communications networks for their own needs, important among which is traffic management and operational data communications between government offices, schools and buildings.

Research and interviews that we conducted for this project also revealed that a number of cities and counties have encountered barriers to their use of fiber optic network facilities placed by FDOT as well as local governments for ITS. These barriers include legal and policy limitations on the use of FDOT ITS facilities and an absence of state and local government coordination in network development and management. This barrier limits collaboration at all levels of government.

Our financial modeling shows that infrastructure sharing can be economical when it leverages otherwise underutilized resources; however, these economies can disappear and efficiencies can be lost if the sharing triggers additional investment by governmental entities.

Recommendation #5: Appropriate state authorities should seek waivers of federal requirements that hamper the ability of state and local government to share facilities when such sharing would be economically beneficial to taxpayers. Furthermore, the enhanced collaborative efforts recommended above should include methods for breaking down legal and policy barriers between state and local governments that limit economical sharing of assets.

2.2.4.3 Competitive Access

The DMS contract with AT&T for MFN services permits use of competitive access for connection to the MFN network. Local units of government and regional entities generally are unaware of the competitive access option. We found that the competitive access provision has not been used in practice, although this may be because this provision is relatively new, that real opportunities are rare, or the fixed costs of planning and contracting are high, which means that projects must be large scale to be economical. Indeed DMS is now working on such a large scale project with AT&T and a regional network provider.

DMS's Telecommunications Infrastructure Project Services or TIPS may be useful for facilitating competitive access. TIPS assists DMS customers in procuring, installing and project managing telecommunications infrastructure with a single point of contact.²³ TIPS relies upon commercial contractors, but this type of service could be extended to collaborate with local jurisdictions operating underutilized broadband networks to connect MFN locations to the MFN.

Recommendation #6: We recommend that DMS and its clients be encouraged to continue exploration of opportunities to implement competitive access to MFN, including the possibility

²³ Department of Management Services, *Division of Telecommunications Business Model*, 16.

of using underutilized network facilities of local governments, FDOT, or others. Such exploration would enable DMS and other parties to gain experience and develop processes and procedures for working with customers who pursue this option. During the exploration, the parties and DMS should identify and document the technical requirements and processes associated with competitive access to potentially simplify use of this option in the future. The opportunities should be rigorously evaluated for both economic and technical feasibility.

2.2.5 Maintenance of Statewide Broadband Maps

The number of e-government services and other government applications that utilize broadband services is projected to expand in the future. In order to help ensure that the public investment in those services is efficiently used, the state should develop and maintain an accurate inventory of broadband services available to and used by government and anchor institutions. Indeed this work has begun with the NTIA grants to the state for broadband mapping. Continuously updated maps and accompanying data showing areas of service availability will facilitate planning for broadband provisioning to anchor institutions that are state clients. The supplemental funding recently awarded by NTIA through the State Broadband Data and Development Grant Program will facilitate data and map updates through 2015.

This mapping can illustrate the potential of using local networks to interconnect state government locations to the MFN.²⁴ For example, we found the currently available mapping information useful for this project, and have used that information for this report.

Recommendation #7: The state should continue the current DMS effort of developing and maintaining statewide broadband maps as they relate to governmental and anchor institutions. An option for ensuring the usefulness of this planning resource would be authorization of funding to establish and maintain a process for continuously updating the broadband maps and data to support enterprise technology planning decisions after the federal funds are exhausted.

2.2.6 Flexibility and Innovation

DMS is authorized by law to “to plan, design, and conduct experiments for telecommunications services, equipment, and technologies, and to implement enhancements in the state telecommunications network if in the public interest and cost-effective.”²⁵ Funding for such experiments must be derived from SUNCOM network service revenues.

Experimentation with leveraging of underutilized assets of other governmental entities, alternative technologies where appropriate, competitive access, and the like, if properly monitored and supervised, could be beneficial to governmental broadband users. In certain

²⁴ One example shown overlays MFN locations on the Palm Beach County broadband network (both county ITS and county communications networks). This example is discussed in further detail in the Collaboration section.

²⁵ 282.702(13) Florida Statutes.

situations such experiments could be funded at least in part from SUNCOM network service revenues.²⁶

Our recommendations above regarding competitive access and leveraging of underutilized government network facilities, if they were to be implemented, necessarily involve MFN clients taking more initiative, perhaps working with local governments or others who are not part of MFN to gain access to MFN or to obtain other broadband services. This could lead to an increased number of requests for exemptions from mandatory use of SUNCOM services.

Some people we interviewed believed that DMS is reluctant to grant exemptions to the statutory requirement that state agencies obtain network services exclusively from DMS. To our knowledge, a request for exemption has happened only once with respect to MFN.

Within the past five years, DMS completed a several-month process, including public hearings, to rewrite its rules in 60FF F.A.C. regarding SUNCOM exemptions. DMS believes the exemption process in 60FF-1 F.A.C. is much more responsive, transparent and simple than the antiquated process it replaced.

Recommendation #8: We recommend that DMS and its clients continue to look for ways to improve the overall efficiency of broadband procurement by leveraging underutilized assets, experimenting with new technologies where reasonable, and identifying processes for improving efficiency. Local governments are likely to be useful laboratories for ideas and approaches. In the context of our recommendations for innovation and adaptability of service provisioning, DMS and its clients should continue to watch for potential improvements in ways the ways with which reasonable exemptions can be identified, supported, and granted. Such policies and procedures would likely include methods for working with requesting agencies to identify those telecommunications solutions that meet the agencies' needs in the most cost-effective manner, as well as providing additional information to agencies on these policies and practices.

2.2.7 Performance Monitoring

We reviewed and analyzed prices for network components for Florida's MFN and reviewed prices for state governments' network services in other states. While a simple comparison of prices to other states may be interesting, it is at best problematic to draw conclusions from such as comparison because it lacks context and there are significant differences in price structure.

A proper comparison of network service prices, which is beyond the scope of this study, would

²⁶ Experiments authorized by statute are not the only means DMS has to keep abreast of current technology. DMS appears to be using the procurement process to leverage its capabilities and understanding of technology. The recent and still open procurements for mobile communication services and Next Generation 911 service are examples of this.

compare prices in the context of cost, network, demand, and service differences across the states. As is well understood in economics, supply and demand are fundamental to determining prices and these market forces are driven by a number of factors including wages, geography and population, economic activity, and the features of the services offered. Furthermore, how supply and demand interact to arrive at prices is affected by the timing at which prices are established, the methods of contracting, and industry and economic conditions at the time of contracting.

A proper comparison across states would inform the state strategic planners regarding the effectiveness of the overall strategic plan, enterprise planning, and procurement. It would also decrease the information asymmetry between government broadband purchasers and private network operators, increasing the chances that the private operators would offer more attractive prices and services.

The AT&T contract with the state for MFN services provides for benchmarking of contract prices in Florida against those in other states. DMS utilized that benchmarking provision during the process of negotiating the MFN extension. The benchmarking provision has value as a price-monitoring tool that could provide useful information to DMS during the extended term of the MFN contract leading up to the next procurement. The effectiveness of benchmarking could be improved with proper analytical techniques and the associated data gathering, which are labor-intensive and require specialized skills.

Recommendation #9: In preparation for the next round of broadband network services provisioning, the state should undertake, two years prior to expiration of the contract, a robust examination of costs for comparable services in other states. In the future, a regular benchmark analysis should be pursued approximately halfway through a contract term, but not less than two years prior to the expiration of the contract.²⁷

2.2.8 Federal E-Rate Funding for Schools and Libraries

Our research showed that in past years Florida did not appear to be as successful as other states, such as New York, Illinois, and Ohio in obtaining E-rate support.

We were unable to trace the cause for this difference between the success rates of Florida and its peer states; however, the difference appears to be unrelated to any differences in criteria for qualifying for E-rate support.

Florida has obtained a federal grant to develop an E-rate support team for the purpose of improving Florida's success in obtaining E-rate subsidies.

²⁷ The costs for such an analysis should not be large, probably between \$50,000 and \$100,000, compared to the expected benefits.

Recommendation #10: Governmental entities in Florida, such as the Florida Legislature’s Office of Program Policy Analysis and Government Accountability, should work with the DMS E-rate support team to identify best practices of states that have been effective in receiving outside funding for obtaining broadband.

3 Report Methodology

The methodology used to derive our findings makes use of both qualitative and quantitative research and analysis. The qualitative research involved a document-based review and analysis of a variety of broadband-related information and interviews with key personnel and stakeholders. The quantitative method involved developing and analyzing the results of a cost-model as well as analyzing a variety of data regarding state agency use and financing of broadband services and the costs of those services.

3.1 Qualitative Method

3.1.1 Literature Review

Part of the qualitative method involved learning about the history and specific characteristics of the broadband networks used by Florida’s state government as well as the history and general characteristics of government networks used in four other states: Illinois, New York, Ohio, and Pennsylvania. These states were selected by PURC and DMS based on population. A discussion of broadband provisioning and management practices in these four states is included in Vol. II SD Sec. 16. We also reviewed the policy and legal framework (constitution, and statutes) governing the selected state networks, as well as certain federal policies governing broadband deployment and adoption. Furthermore, we engaged in a literature review regarding a wide array of broadband-related issues, including drivers and trends for broadband service, use and deployment, as well as broadband-supported applications for healthcare, education, public safety, libraries, and transportation.

3.1.2 Interviews

Discussions with state government IT managers whose agency uses and purchases broadband services, and discussions with service providers informed us about their perceptions regarding successful practices and as well as their concerns. We gathered information through interviews, sometimes held more than once, with the following Florida state agencies: AEIT, the Agency for Health Care Administration, the Department of Children and Families, the Department of Education, the Department of Transportation, the Department of Transportation Intelligent Transportation Systems Office, the Department of State/Division of Libraries, the Fish and Wildlife Conservation Commission, DOC, the Department of Management Services DivTel, the Department of Management Services Public Safety Bureau, the Department of Law Enforcement, the Department of Revenue, the Department of Health, the Board of Governors for the State University System, the Department of Community Affairs, and the Division of Emergency Management; and other stakeholders including FLR, and the Technology Review Workgroup (TRW), a statutory legislative committee. In addition, we met with library directors at the State Library Directors Association meeting. We interviewed several times senior management in both DMS DivTel and FLR to gain a better appreciation of the broadband

services provided by both organizations.

Local government practices for obtaining broadband services are another focus of this report. In order to gather the necessary information, we interviewed local government IT managers and leaders regarding local government practices in Florida. Based on those interviews, we provide two examples: Gainesville and Palm Beach County. The creation of NFBA and the FRBA after this project started illustrates the evolving nature of the broadband environment in Florida. We interviewed senior management at NFBA for this report.

3.1.3 Meetings

We obtained information that helped develop the context for this report by attending and participating in national, state and regional meetings. Participation in meetings of the Library Directors, Broadband Workgroup, and the Florida Local Government Information Systems Association afforded us an opportunity to explain the purpose of the study and make contacts that proved critical for our information-gathering efforts. Attendance at broadband conferences at Columbia University and Wichita State University helped us acquire a better understanding of national trends and drivers for the use of broadband services. Insights gleaned from the meetings are reflected in this report.

In addition to attending meetings hosted by other organizations, PURC organized a facilitated Service Provider Forum on November 18, 2010 in Tallahassee. Twenty telecommunication service providers, including representatives of municipal utilities, participated in the forum. A list of forum participants can be found in Vol. II SD Sec. 22.

3.2 Quantitative Method

3.2.1 Broadband Utilization Analysis

To better understand the use of broadband service by MFN users, we analyzed billing data for MFN by state agency. Actual port and loop capacity for MFN customers was reviewed both overall, and we also reviewed use by many specific agencies and customers.

3.2.2 Mapping

We also utilized some geographic analysis techniques. DMS contracted with GeoPlan at the University of Florida as part of the grant-funded project to map community anchor institution locations and incorporate broadband networks in Florida. This mapping shows some local networks and their characteristics as provided on a voluntary basis, and can be viewed at <http://oscar.geoplan.ufl.edu/flexviewer/>.

MFN locations are shown, but MFN, FLR and FDOT ITS facilities are not included on the map.

The MFN core network is provided over AT&T’s network, while FLR’s network is provided over Level 3 facilities. FDOT ITS networking is not considered to be public information²⁸, and thus is not available for presentation on a public mapping tool. Graphical depictions of the MFN and FLR networks are included in Vol. II SD Sec. 14. These depictions show a general geographical location of facilities.

3.2.3 Financial Modeling

The cornerstone of our quantitative analysis is the financial modeling conducted for this study. A basic question for this analysis is whether the State of Florida would be financially better off with a different system for governmental entities to procure and use broadband services. In Vol. II SD Sec. 13, we describe in greater detail the approach we take toward modeling the financial impacts, including the methodology used. The results are included in Section 11 and in Vol. II SD Sec. 13 of this report.

²⁸ Section 7.3.2 provides the explanation and statutory basis for not distributing FDOT ITS facilities locations to the public.

4 Broadband Trends

4.1 National and International Trends

Through our research we identified two major issues affecting broadband expansion efforts: capacity and quality. Choice regarding delivery models for broadband impact the economics of capacity and quality, which are complex because of the number of variables. First and foremost, nobody can predict with certainty how technology will be used in the future. However, we know the demand for video applications will continue to put pressure on the capacity of broadband networks. We also know that applications vary in their quality needs. For example, real time video needs higher priority for transmission than does processing of some day-to-day transactions; and private information about citizens needs greater security than public information about regulatory agency proceedings.

In the larger context, Cisco's forecast for 2009-2015 may give us some insight about what we might expect. According to Cisco's Visual Networking, "annual global IP traffic will exceed three-quarters of a zettabyte (767 exabytes) in four years. Global IP traffic grew 45 percent during 2009 to reach an annual run rate of 176 exabytes per year or 15 exabytes per month. In 2014, global IP traffic will reach 767 exabytes per year or 64 exabytes per month. The average monthly traffic in 2014 will be equivalent to 32 million people streaming Avatar in 3D, continuously for the entire month."²⁹ Consumers' demand for video applications will outpace business traffic by 2014 and video will be a two-way experience.³⁰ Upstream video applications are also projected to grow in importance as service differentiators.³¹

Two major technological trends in recent years have transformed how broadband has been deployed: the widespread deployment and use of fiber technology and mobile (wireless) broadband in the U.S. and elsewhere. Fiber is used for both access and transport, while mobile broadband is used for access. We discuss each briefly below.

4.2 Fiber Deployment for Access

The expansive deployment of fiber for access in the U.S. was spurred several years ago by Verizon with its fiber to the premise (FIOS) and by AT&T with its roll-out of fiber to the node (Uverse). As reported in a recent Standard & Poors report, "the transition to bandwidth-rich fiber technologies is allowing the telecom carriers to bundle video along with voice; it also allows high-speed Internet providers to better compete with the cable and satellite operators. The launch of video capability has included competitive enhanced services such as video on demand (VoD)

²⁹ Cisco, *Cisco Visual Networking Index*.

³⁰ Pepper, "Next Generation (Ultra Broadband) Demand."

³¹ Ibid.

and high-definition television (HDTV).”³²

In 2009, fiber connections accounted for 5 percent of customer connections in the U.S.³³ (Other countries have also been deploying fiber and report a far greater percentage of fiber connections, most extensively in 2009 Japan (54 percent), Korea (49 percent), Slovak Republic (28 percent), and Sweden (23 percent), although population density/geographic expanse and deployment of technologies that compete with fiber for connections, namely cable modems and DSL, are much different in these countries than in the US.³⁴) On the upside, fiber, in contrast to, say, DSL, enables for much higher transmission speed or capacity. On the downside, it is much more costly to deploy. For example, according to the *New York Times*, it cost Verizon an estimated \$4,000 per new subscriber in capital costs, at least in the earlier phase of the roll-out.³⁵

In the U.S. an experiment with fiber to the home is underway in Chattanooga, Tennessee which, through a municipal utility, offers fiber to the home for \$350 a month. However, questions arise: Will people pay for the service and do they need so much capacity? Will they find ways to use it if they have it? Can they afford it? The jury is still out as to whether FIOS or other large-scale fiber deployment projects offer a good return on investment in the long-term in the U.S. The U.S. is not as densely populated as Japan and Korea and other technologies, such as DSL and cable modems, are widely deployed in the United States. Therefore, fiber penetration of the magnitude realized in those countries may be slower to develop in this country.

4.3 Fiber Deployment for Transport

Fiber technology, like that of earlier IT such as discs and the mainframe, will likely evolve in its uses in the network. Fiber is now predominantly used in information networking as a means of transmitting data, voice, and video applications. Fiber is used as “trunks,” virtually unlimited super information highways, to “feed” fixed and mobile access broadband service. In other words, fiber facilities provide backhaul and backbone capability for all forms of access and have the advantage of scalability.³⁶

Technology change permits deriving significant additional capacity from individual fibers. Representative of this is DWDM, or Dense Wavelength Division Multiplexing, which in effect

³² Standard & Poor’s, *Telecommunications, Wireless Industry Survey*, 12.

³³ Organisation for Economic Co-operation and Development, *Broadband Portal*, Penetration Table 11, “Percentage of Fibre Connections.” According to a more recent report by the Fiber-to-the-Home Council North America, fiber accounts for just over 6% of all broadband users in the United States. See Fiber-to-the-Home Council, *Consumer Usage Patterns and Attitudes*, 3.

³⁴ Organisation for Economic Co-operation and Development, *Broadband Portal*, Penetration Table 11, “Percentage of Fibre Connections.”

³⁵ Hansell, “Verizon’s FiOS.”

³⁶ Tofel, “T-Mobile Extends HSPA.” [This was in reference to the 3.5 G network roll-out by T-Mobile.]

transforms a single fiber into multiple virtual fibers.³⁷

4.4 Mobile Broadband

Mobile broadband³⁸ service is the second major trend to change the pattern of broadband deployment.³⁹ For the first time in 2008, as shown in Figure 4-1 the global number of mobile broadband subscribers surpassed that of fixed broadband subscribers. This means in the future, mobile broadband subscribers are more likely to have their first exposure to the Internet through handheld devices. Seventy percent of young people age 18-29 use laptop computers, and of that number, 65 percent are online wireless users – the highest percentage of all age cohorts 18 years old and older.⁴⁰

Mobile broadband use by government is significant in Florida, as described in Vol. II SD Sec. 14.3.7 and 19.2.3.2. The advances in mobile broadband technology exemplified in the increasing array of smart phones and “apps” as the wireless networks evolve to implementation of 4G wireless networking suggests that mobile broadband use in government will only be increasing.⁴¹ Federal Communications Commission (FCC) designation of public safety mobile broadband capacity in the 700 MHz bands is aimed at leveraging these trends for public safety purposes. “Implementing such an approach could give public safety officials communications tools that are as good as those now available to the average consumer, but with the advantages of dedicated bandwidth, superior network reliability and hardened devices, etc.”⁴² Florida is not likely to be different from the International Telecommunications Union data trends which show that gains in mobile broadband utilization are outstripping gains in fixed line broadband utilization. This consumer experience is indicative of trends government will face in that there will be increasing need for connection of mobile devices to MFN. Mobile broadband connectivity to MFN is one need that is foreseen and addressed by the DMS Mobile Communication Services Invitation to Negotiate (ITN).⁴³

³⁷ <http://www.webopedia.com/TERM/D/DWDM.html> (accessed January 10, 2011), as cited at endnote 97 in Department of Management Services, *Division of Telecommunications Business Model*. DWDM is used in Florida and in the states whose networks we reviewed (New York, Ohio and Pennsylvania). Examples of the use of DWDM include Florida LambdaRail and Miami Dade County. Palm Beach County is using another wave division multiplexing technique—Coarse Wavelength Division Multiplexing.

³⁸ As with fixed line, there is disagreement about that which constitutes broadband in mobile communications. Numerous technologies are used with varying bandwidths and capabilities.

³⁹ Mobile broadband is the predominant use of wireless technology for access, although some fixed wireless is also used.

⁴⁰ Smith, *Mobile Access 2010*, 21.

⁴¹ 4G stands for fourth generation mobile communications. It can more easily serve high bandwidth applications, such as mobile streaming video. The most prominent 4G technology is LTE, which stands for Long Term Evolution.

⁴² Department of Management Services, *Division of Telecommunications Business Model*, page 53.

⁴³ Department of Management Services, *Invitation to Negotiate for Mobile Communication Services*.

Figure 4-1. Global Fixed & Mobile Broadband Subscribers, 2003-2009

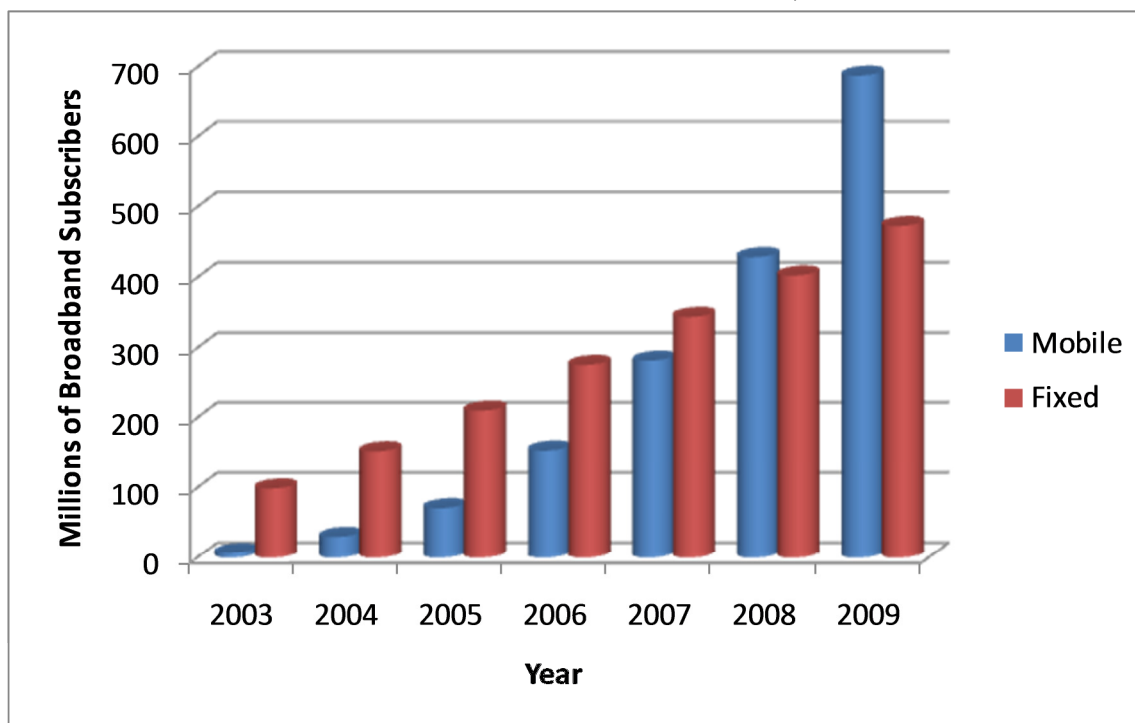

Source: International Telecommunications Union World Telecommunication/ICT Indicators Database⁴⁴

4.5 Challenges

For each type of technology – fixed and wireless – the challenges are somewhat different: Providers of mobile broadband face interference and constrained radio spectrum availability, which is of growing importance given the projected growth in mobile broadband utilization. Providers of broadband connectivity via fiber experience large-sunk capital costs for facilities. Some providers of mobile broadband also face large-sunk costs for spectrum licenses. Ensuring sufficient capacity tends to be less of a problem for fiber than for mobile broadband, all else equal, and network traffic management is more critical in mobile broadband than with fixed broadband. Nonetheless, in each case the same underlying set of concerns surfaces. Companies deploying broadband services through fiber or using spectrum for mobile services need to recover their costs, they need to adopt a business model that recovers costs across a customer base sufficient for them to do so, and they need to manage network congestion.

Regardless of the platform and the funding arrangements to maintain the infrastructure, future broadband networks will need to brace themselves for rapidly escalating demand for capacity

⁴⁴ Zhao, “Telecommunications Services,” 8.

that will require access networks, backbone networks and gateways to the Internet to provide constantly increasing throughput and the capability to manage traffic to avoid congestion. Today the need to transmit and receive large files containing images and video is driving the requirement for more bandwidth and systems that predict congestion and proactively stop it from occurring. One practice, Quality of Service (QOS) management, has been enhanced and made very scalable by standards groups and vendors in order to manage and control congestion on broadband networks that carry increasing volumes of multimedia data. QOS enables network providers to offer differing levels of service and separately price these levels of services. For example, the congestion management approach based on QOS, levels of service and value pricing of different services levels is used by the wireless carrier Vodafone. The Vodafone Group is moving away from fixed pricing to variable pricing based on quality.⁴⁵ According to the company's public policy director, variable pricing provides increased transparency for users, affords them greater choice of price and product, and is arguably more application friendly. In short users pay for the level of service they need. Deutsche Telekom's managing director also views quality of service differentiation and price differentiation as a critical means of enabling future broadband roll-out.⁴⁶ The challenge, of course, is getting the price right, which is no simple task. For example, NII Holdings experimented with a four-speed pricing structure and reduced the speed by 30 percent for those customers consuming more than the allocated capacity.⁴⁷

However, it is clear from our research that users of some government applications find the trade-off of lower quality of service (e.g., downtime) for a lower price to be unacceptable. Many government applications are "mission critical" and cannot be subject to intermittent or unpredictable downtime. One example is that criminal justice officials require immediate access to fully up to date databases, such that it is unacceptable for a vehicle registration, driver license or criminal history database to not be accessible at the moment of need. Critical applications are enumerated and discussed in more detail at Vol. II SD Sec. 14, and Vol. II SD at Appendix IV. Agency impacts of downtime are provided at Vol II SD Appendix IV.

4.6 Broadband Trend Implications for Florida

At least a portion of the increased realized demand for broadband services should be attributable to expanded access as broadband facilities, using both fiber and wireless technologies become more ubiquitous. Although broadband in the United States is largely provided by private carriers, the availability of federal stimulus funding is expanding access in more sparsely populated areas. In Florida and elsewhere, federal ARRA infrastructure funds were awarded in large part to fund middle-mile connectivity. As noted below, NFBA received funding to

⁴⁵ Feasey, "Tools to Optimize Use."

⁴⁶ Wieck, "Tools to Optimize Use."

⁴⁷ Le, "Tools to Optimize Use."

construct its network using wireless technology to connect anchor institutions in 14 predominantly rural counties. The FRBA also received funding for the same approach for 15 counties.⁴⁸ Other ARRA-funded middle-mile projects rely on fiber connectivity.

On the state agency level, the broadband provisioning business model also may need some review in order to consider trade-offs between quality and price in Florida. Currently Florida's state agencies experience the same service quality and pay the same rates per increment of capacity under the MFN contract. Agencies do not have the option to choose a lesser quality service for less money for applications whose data transmissions are not time sensitive. For example, if State Agency A uses MFN intensively for two-way interactive video training and State Agency B uses it for data transmission that is not time sensitive and has no need for real time video-based transactions, both agencies receive the same quality of service and pay the same rate provided they are in the same total capacity tier. However, Agency B actually does not need the quality of service that Agency A needs. Quality differentiation with associated price differences could enable a budget savings for Agency B. We analyze the cost aspect of such differentiation in this report.⁴⁹

However, quality of service differentiation is not as simple as our example of agencies A and B might make it appear. If agencies have choices, consideration would need to be given to impact on MFN pricing over time for agency applications that require the high availability and reliability offered by MFN,⁵⁰ which are two important dimensions of quality. As we discuss in our description of our financial modeling Scenario 3, consideration should also be given to institutional and political factors that may work against client agencies living with the consequences of their choices such that an agency might be able “to have its cake and eat it too” by means of interference by political actors. For example, agencies may be able to successfully demand features from DMS of the higher-priced service such as problem resolution within four hours, even though the agency only paid for the lower quality of service. Cost containment strategies may also be realized through two trends that are garnering considerable scrutiny in state and local governments and that rely on broadband service: data center consolidations and cloud computing. A recent Kansas legislative performance audit provides the following explanation of cloud computing: “With cloud computing clients lease space on third party servers—such as those owned by Google or Amazon—and access their data remotely through the Internet. Here are some examples of cloud services an agency might purchase: web-based email services; a test server when developing agency applications; data storage; data backup;

⁴⁸ National Telecommunications and Information Administration, *Broadband USA Applications Database*.

⁴⁹ More specifically we analyze this possibility in Scenario 3. This option appears to provide an opportunity for cost savings for government broadband users in Florida.

⁵⁰ This high level quality of service is often referred to as “five 9’s”, indicating the network is engineered to be available and operating 99.999% of the time.

spam filtering for the agency-administered email system; and online surveys.”⁵¹ Cloud computing has both advantages and disadvantages: An advantage is potentially lower costs as customers would not need to buy and administer hardware or software. Disadvantages include risks for confidentiality, security and privacy since data and information are managed by a third party.⁵² It should be noted that the “cloud” metaphor is not entirely new, and that in the past, as well as currently, there have been private network “clouds” as well as public network “clouds.” The current trend is movement toward larger Internet-based cloud services due to lower costs, fast development and deployment, ease of use, and ubiquity of the Internet for distribution and access.

Data center consolidations are intended to realize long-term net savings by aggregating storage and processing capability, and by reducing the number of servers and potentially lowering utility costs. (See discussion of consolidation and shared services in Vol. II SD Sec. 20.2.) Section 282.201 et seq., Florida Statutes, provides the statutory framework in Florida for state agency data center consolidation including criteria to be considered and timelines for migration. Currently, there are two primary data centers established in statute: Northwood Shared Resource Center and Southwood Shared Resource Center.

Cloud computing/data center consolidation has major implications for broadband capacity—thus the emphasis in our report on a unified ICT planning approach. In a cloud computing approach, the applications reside in the cloud and the user is dependent on the broadband Wide Area Networking capacity to get from the user’s location to the application in the cloud. This is in contrast to the common current environment where the user’s applications reside either on the desktop computer, or network server (or both), which are tied together with a Local Area Network. The contrast between the broadband Wide Area Network (WAN) capacities required by these two alternatives is quite stark—under the Local Area Network (LAN) approach most applications are local, under the cloud computing approach applications are housed in the cloud. One trade-off for cloud computing efficiencies in providing for applications is that much greater broadband capacity is required to support that approach.

⁵¹ Kansas Legislative Post Audit Committee, *Performance Audit Report*, 23.

⁵² *Ibid.*

5 Drivers for Government Agency and Anchor Institution Use of Broadband Technology

Government agencies and anchor institutions utilize broadband data transmission in order to communicate with the public, businesses and other governmental units via a variety of different media and to provide services more effectively. Broadband technological improvements can enhance efficiency of operations within and among anchor institutions and between anchor institutions and businesses.⁵³ Critical applications (as well as other less critical applications) which support anchor institution operations use the MFN, and those critical applications are described at Vol. II SD Sec. 14.3 and at Vol. II SD Appendix IV. The paragraphs below describe examples of the application of technology to core functions (of varying criticality) that drive the demand of anchor institutions for broadband connectivity.

5.1 Education

Institutions of higher education that conduct interactive video courses online enable working students to complete their education or retrain for a new career without leaving their current jobs or incurring the expense of moving to a college town.⁵⁴ Florida facilitated use of distance education techniques in postsecondary education by creating the Florida Distance Learning Consortium in 2009.⁵⁵ In the K-12 education arena, the Florida Virtual School provides an online educational resource for students throughout the state and beyond.⁵⁶ While not all online

⁵³ MFN, in a number of agencies' view, provides significant cost efficiencies over the data transport network it replaced. See for example the description of Florida Department of Law Enforcement's experience with the transition to MFN at Vol. II SD Section 7.2.3.1.

⁵⁴ Sections 1009.24(17)(a) and 1009.23(16)(a), Florida Statutes., define "distance learning course" for fee purposes to mean "a course in which at least 80 percent of the direct instruction of the course is delivered using some form of technology when the student and instructor are separated by time or space, or both." See, example distance learning course listings for Florida community colleges, Florida independent colleges and universities and public universities at <http://www.distancelearn.org/>. At Florida State University a social science undergraduate degree may be earned online: <http://www.career.fsu.edu/occupations/matchmajor/social-sciences.html>, accessed November 13, 2010.

⁵⁵ Section 1, Ch. 2009-92, Laws Of Florida, codified, as amended in 2010, at section 1004.091, Florida Statutes.

⁵⁶ "Florida Virtual School (FLVS) is an established leader in developing and providing virtual K-12 education solutions to students all over Florida, the U.S. and the world. A nationally recognized e-Learning model and recipient of numerous awards, FLVS was founded in 1997 and was the country's first, state-wide Internet-based public high school. Today, FLVS serves students in grades K-12 and provides a variety of custom solutions for schools and districts to meet student needs." "Florida Virtual School," <http://www.flvs.net/Pages/default.aspx>, accessed November 13, 2010. An annual survey conducted in 2009 by e.Republic's Center for Digital Education to evaluate online learning policy in the US showed growth in state support for online programs in K-12 education. Results of the survey in both 2009 and 2008 showed Florida as the top state in online education. The report cited the Florida virtual school with nearly 125,000 students, a 25 percent increase in attendance over 2008. The press release accompanying publication of the survey results quoted the Florida Commissioner of Education, "Digital learning is truly the wave of the future, and I'm honored Florida has once again been recognized for our efforts. Our drive to

courses involve the use of interactive video, broadband speeds at least as high as currently defined by the FCC are beneficial if not necessary for people using those applications.⁵⁷ Many Florida Internet users go online for educational purposes. As provided through DMS's contract with Connected Nation, the Connect Florida survey of state residents shows that statewide, 38 percent of Internet users conduct research for schoolwork online; 38 percent interact with teachers online; and 27 percent take classes online. Furthermore, the survey results show that rural Internet users are more likely than the state average, to take classes online.⁵⁸

Learning management systems (LMS) provide an example of a new approach to curriculum development. In October 2010, the Florida Senate Committee on Education Pre-K-12 issued Interim Report 2011-115 that addresses 2010 legislation that encourages Florida's local school districts to develop LMS.⁵⁹ The report notes that "LMS provides electronic access to curriculum, individualized instruction, robust resources, ongoing assessments, professional development, and student achievement data in a secure environment."⁶⁰ LMS access is available to students, teachers, parents, and administrators on an anytime, anywhere basis using a variety of technology tools.⁶¹ The Committee found that in 2010 only seven Florida districts currently deploy a fully operational electronic LMS that encompasses the desired functionalities. Contributing to the limited adoption of LMS to date may be the absence of "a collaboratively developed technology plan that clearly describes how technology will be used to improve teaching and learning, and that identifies statewide policy directives to which state and local IT investments can be aligned."⁶²

The Department of Education has identified some new applications that will require broadband capacity to operate. There is a trend that all state departments of education are becoming more connected to local districts.⁶³ One new program being implemented in Florida that is consistent with this trend is the "Florida Assessments for Instruction in Reading" or FAIR program. It is provided to K-12 public schools as a "new assessment system [to] provide teachers with

offer increased educational options for our students has allowed us to excel in this important area and I hope our success can serve as an inspiration for other states to more actively pursue online learning programs." Florida Department of Education, "National Survey Finds Substantial Increase in Online Education."

⁵⁷ Federal Communications Commission, *Broadband Performance* and Federal Communications Commission, *National Broadband Plan*, Chapter 11, Education.

⁵⁸ Connect Florida, *Connect Florida Residential Technology Assessment*. The survey of 1,048 Florida Internet users was conducted by telephone between March 5 and April 5, 2010.

⁵⁹ Florida Senate, "School District Information Technology Procurement." Refers to ch. 2010-154, L.O.F.

⁶⁰ *Ibid.*, 1.

⁶¹ *Ibid.*

⁶² *Ibid.*, 4.

⁶³ Interview by David Brevitz and Herb Cash, Public Utility Research Center, University of Florida with Ron Lauver, Special Assistant to the CIO, and Ted Duncan, Chief, Education Data Center, Office of Technology and Information Services, Florida Department of Education, November 4, 2010.

screening, progress monitoring and diagnostic information that is essential to guiding instruction.”⁶⁴ FAIR will have a peak bandwidth requirement of T-1 or 1.544Mbps.⁶⁵ Also, the Florida Department of Education (DOE) is implementing “Race to the Top” projects, for which additional systems will be developed, and some will be online. It is viewed as likely that these systems will generate many transactional hits using broadband capacity.⁶⁶

Finally, the Florida Information Resource Network (FIRN) is a networking application for education that is provided by DMS. FIRN is discussed in more detail in Vol. 2 SD Sec. 18.2.

5.2 Law Enforcement

Broadband connectivity can enable information sharing among law enforcement officers regarding a wide array of issues (incidents, dispatch records, warrants, traffic citations, field interviews, bookings, permits, mug shots, pawn data).⁶⁷ Magellan Advisors, LLC., provided the following information about a collaborative record management initiative used by law enforcement agencies in Seminole County:

In Seminole County, all 7 municipal police departments operate on the Sheriff’s Records Management System and Computer Aided Dispatch (CAD) system. This sharing of application resources from the Sheriff’s Office is only possible through the existence of a County-owned fiber optic network that enters each municipal police station. By leveraging the same Records Management System and CAD system, law enforcement activities have been streamlined and enhanced throughout Seminole County. Additionally, by providing each municipality access to their systems, the cities were able to reduce their law enforcement operational budgets by eliminating the need to license and support their own Records Management Systems and/or CAD systems.⁶⁸

The Harvard Kennedy School’s Ash Center for Democratic Governance and Innovation recently recognized 173 government programs in its newly created Bright Ideas program. “Bright Ideas is designed to recognize and share creative government initiatives around the country with interested public sector, nonprofit, and academic communities.”⁶⁹ Among the local programs

⁶⁴ <http://www.fcrr.org/FAIR/index.shtm> (accessed February 7, 2011)

⁶⁵ <http://www.fldoe.org/faq/default.asp?Dept=4&ID=1280#Q1280> (accessed February 7, 2011)

⁶⁶ Interview by David Brevitz and Herb Cash, Public Utility Research Center, University of Florida with Ron Lauver, Special Assistant to the CIO, and Ted Duncan, Chief, Education Data Center, Office of Technology and Information Services, Florida Department of Education, November 4, 2010.

⁶⁷ See Vol. II SD Sec 19 for description of sharing of information among criminal justice officials via the Criminal Justice Network (CJNet) operated by FDLE.

⁶⁸ Magellan Advisors, LLC, *Local Government Communications Use*. See Vol. II SD Appendices I and II.

⁶⁹ Harvard University, “New Bright Ideas Recognizes Innovative Government.”

recognized is the Virtual Inmate Processing and Reporting (VIPAR) system implemented in Pinellas County. According to the Ash Center project description, VIPAR, an electronic arrest affidavit technology, has eliminated the use of hand-written, multi-page arrest forms. VIPAR is described as a “cost-effective and time-saving innovation that has improved efficiencies among 27 local, state, and federal law enforcement and criminal justice agencies in Pinellas County, Florida.”⁷⁰

A project that will facilitate the sharing of such data in the state is the Florida Law Enforcement eXchange system (FLEX). There are currently three regional exchange networks that have worked together (Fort Meyers, Miami, and Tallahassee) to develop the methodology for data sharing under FLEX. The methodology has not yet been procured or operationalized but when implemented it will be provided over Criminal Justice Net (CJNet).⁷¹ Similarly the state-wide exchange envisioned in FLEX has not yet been implemented.⁷²

5.3 Health Care

Health care providers perform screening examinations and review radiology images remotely using instruments that send images via broadband from one health care facility to another saving them and their patients time and enabling timely treatment.⁷³ Home health entities increase their efficiency by gathering health status information from clients using monitoring devices that transmit information to public health agencies.⁷⁴ Telemedicine is emerging at Florida Department of Health county clinics. Furthermore, use of tele-radiology for the tuberculosis program has been growing during the past five years, as supported by hospitals in Gainesville, Jacksonville, and Lantana.⁷⁵

⁷⁰ Ibid.

⁷¹ The Criminal Justice Network is used to “maintain and share criminal justice information across a communications network for Florida’s more than 760 criminal justice agencies. Law enforcement and other criminal justice agencies have access to the state’s criminal justice databases 24 hours a day, 365 days a year.” See Florida Legislature, “Department of Law Enforcement, Criminal Justice Information Services.” CJNet is provisioned over MFN.

⁷² Interview by David Brevitz, Herb Cash, and Mark Jamison, Public Utility Research Center, University of Florida, with Penny Kincannon and Joey Hornsby, Florida Department of Law Enforcement, December 3, 2010. See also, Florida Department of Law Enforcement, “Welcome to the Law Enforcement Project” and Florida Department of Law Enforcement, *2010 Florida Data Sharing Status*.

⁷³ The FCC cited in its National Broadband Plan a 2007 study by the Center for Information Technology Leadership describing use of video consultation instead of in-person doctor visits for prisoners, nursing home residents and hospital patients who need outside experts that could save \$1.2 billion annually. See Federal Communications Commission, *National Broadband Plan*, Chapter 10, Health Care, citing footnote 23.

⁷⁴ Federal Communications Commission, *National Broadband Plan*, Chapter 10, Health Care, citing, among others, footnote 27.

⁷⁵ Interview by David Brevitz and Herb Cash, Public Utility Research Center, University of Florida, with Bret Hart,

Healthcare applications are of interest to Floridians. The Connect Florida survey of residents showed that approximately 29 percent of residents (33 percent of Florida Internet users) interact with doctors or healthcare professionals online.⁷⁶ Broadband connectivity is critical to supporting new systems for sharing electronic medical records.⁷⁷ Uses for those records include: preventive care, chronic disease management, care coordination, medication management, and emergency medical treatment.⁷⁸

The FCC's National Broadband Plan cites a study that claims that "electronic health record systems have the potential to generate net savings of \$371 billion for hospitals and \$142 billion for physician practices from safety and efficiency gains over 15 years."⁷⁹ To further what is now a federal objective, the Florida Agency for Health Care Administration received federal stimulus money to support exchanges among health care organizations of electronically transmitted health information.⁸⁰ Although broadband connectivity was not explicitly required as a means of providing such connectivity, it is an essential component.⁸¹

5.4 E-government – Residential Users

Government agencies routinely provide certain information and services online. The practice has been dubbed "e-Government." Such services of Florida governmental entities are accessed by many of the state's Internet users as shown in the results of a 2010 survey conducted by Connect Florida as part of the federal State Broadband Data Development (SBDD) project. Those survey results reveal that among Florida's Internet users:

- 57 percent search online for information about government services or policies;
- 42 percent conduct online transactions with government offices;
- 39 percent interact with Florida state government offices;
- 31 percent interact with local government offices; and
- 24 percent interact with elected officials or candidates online.⁸²

Not everyone is flocking to the virtual city hall, however. A Pew Research Center national

Department of Health, December 14, 2010.

⁷⁶ Connect Florida, *Connect Florida Residential Technology Assessment*. The survey of 1,048 Florida Internet users was conducted by telephone between March 5 and April 5, 2010.

⁷⁷ Federal Communications Commission, *National Broadband Plan*, Chapter 10, Health Care, "Health Care Providers' Broadband Needs."

⁷⁸ Brown, "Health Information Technology." Vol II SD Appendix VI.

⁷⁹ Federal Communications Commission, *National Broadband Plan*, Chapter 10, Health Care, citing footnote 17.

⁸⁰ Agency for Health Care Administration, "Florida Health Information Exchange."

⁸¹ Agency for Health Care Administration, *State Health Information Exchange*.

⁸² Connect Florida, *Connect Florida Residential Technology Assessment*. The survey of 1,048 Florida Internet users was conducted by telephone between March 5 and April 5, 2010.

survey conducted at the end of 2009 sheds some light on residents' habits in communicating with government. Interestingly, nothing significant seems to have changed from 2003 to 2009 in terms of the percentage of people who contact government agencies with questions or problems using offline methods, such as telephone, letters, and visits:

In the twelve months preceding our survey, 44% of all Americans contacted their local, state or federal government via offline means. Roughly one in three (29%) called a government office or agency on the phone, one-quarter (24%) visited an office or agency in person and 17% wrote a letter to a government office, agency or official. Since we last asked about offline government contact in August 2003, the proportion of Americans who contact government via telephone or in-person contact has risen by seven and six percentage points respectively, while the proportion of Americans who contact government via letter is comparable to what we found in 2003. In total, the proportion of Americans who contacted any level of government via letter, telephone or in person visits in the preceding twelve months rose five percentage points, from 39% of all adults in 2003 to 44% of all adults in 2009.⁸³

Public libraries have become the focal point for e-government, particularly since budget deficits have forced closing state offices at some locations, with the result that clients now do those things at public computers at public libraries. Effectively libraries become online/internet/broadband e-government access points for lower income Floridians and are an important outlet for government to reach those citizens as well as providing education, research and support for them to find and learn how to use e-government resources. The Department of Children and Families estimates that 90 percent of food stamp applications are made over the internet.⁸⁴ We believe based on statistical trends that public libraries are supporting much of this activity, even as library hours are declining due to budget constraints.⁸⁵

5.5 E-government – Business Users

While much of the recent discussion of anchor institution and government agency connectivity has focused on those agencies working together and with individual residents, an important driver for high-capacity connections for government agencies is to increase the efficiency with which government and businesses communicate. An example of such an application was

⁸³ Smith, *Government Online*, footnote 4, 20. A survey of 2,258 national adults was conducted by telephone in November and December 2009.

⁸⁴ Interview by David Brevitz, Public Utility Research Center, University of Florida, with Ramin Kouzehkanani, CIO, Department of Children and Families, November 8, 2010.

⁸⁵ Interview by David Brevitz, Public Utility Research Center, University of Florida, with Judy Ring, Loretta Flowers, Mark Flynn, Jill Canono and Amy Johnson, Division of Libraries, Department of State, August 20, 2010, with reference to statewide statistics produced by Division of Libraries.

recently recognized by the Ash Center at Harvard’s Kennedy School: “Florida’s statewide restaurant plan review process saves ‘Time, Trees & Stamps’ while accelerating the licensing process, improving customer service, and protecting public health. Program savings include the elimination of postage, electronic submission of plans, and 100 percent paperless document storage for immediate statewide electronic access to files.”⁸⁶

The pie chart in Figure 5-1 displays results from the 2010 Connect Florida survey of small businesses and illustrates the frequency with which Internet-connected businesses in Florida access Florida state government websites. Of particular interest for this report is the finding that 77 percent of businesses that have connections to the Internet report that they access state government websites. Nearly half of those businesses, 35 percent of those with Internet-connections, access state websites several times per month. In addition to those findings regarding frequency, the survey finds that 60 percent of businesses in the state that access state websites do so in order to download forms and documents; 52 percent do so in order to search for state government information; and 29 percent did so to conduct online transactions.⁸⁷

5.6 E-government Applications

When individuals and businesses obtain information from or otherwise interact with governmental entities over the Internet, they utilize a variety of means.

5.6.1 Interactive Video

Public meetings of many types are conducted via interactive video enabling greater participation and transparency and reducing the total travel requirement for participants.⁸⁸ State agencies

⁸⁶ Harvard University, “New Bright Ideas Recognizes Innovative Government.”

⁸⁷ Connect Florida, *Connect Florida Business Technology Overview*. Connect Florida conducted a phone survey of 800 Florida business establishments between June 28 and August 12, 2010. This sample includes 39 businesses with 50+ employees, 72 businesses with 20-49 employees, 277 businesses with 5-19 employees, and 412 businesses with 1-4 employees.

⁸⁸ Questions regarding application of Florida law to meetings of public bodies via electronic means should be referred to competent legal counsel. The Florida Attorney General has issued a number of opinions addressing use of electronic media for public meetings. See, for example: **2006-20** finding that use of electronic media technology to connect simultaneous metropolitan planning organization meetings in various counties constitutes a single meeting of a joint committee created by the MPO’s; **2001-66**, finding that under certain circumstances airport authority members could conduct informal discussions and workshops over the internet, provided proper notice was given and interactive access by members of the public was provided; **98-28** finding that a district school board could use electronic media technology in order to enable a physically absent member to attend a public meeting if a quorum of the members of the board is physically present at the meeting site; **02-82** finding that physically disabled members of the City of Miami Beach Barrier-free Environment Committee could participate and vote on board matters by electronic means if they are unable to attend, as long as a quorum of the members of the board is physically present at the meeting site; and an informal opinion dated March 19, 2007, stating that use of some electronic means of communication may violate the Florida government in the Sunshine Law under certain

such as the Florida Department of Environmental Protection utilize video conferencing to reduce fuel and travel expenses. As of 2010 the Department had 19 separate locations with video conferencing capability.⁸⁹ Governing bodies of many of Florida’s local units of government stream their regular meetings over the Internet and some archive video files of their meetings so that residents who are unable to attend meetings in person or view them in real time are able to view them later.⁹⁰ Likewise, sessions of the Florida Legislature, as well as some legislative committees, can be viewed via the web in real-time and via archived video files,⁹¹ and can be viewed on the Florida Channel.

Figure 5-1. Frequency of Use of State of Florida Government Websites by Interconnected Florida Businesses in 2010

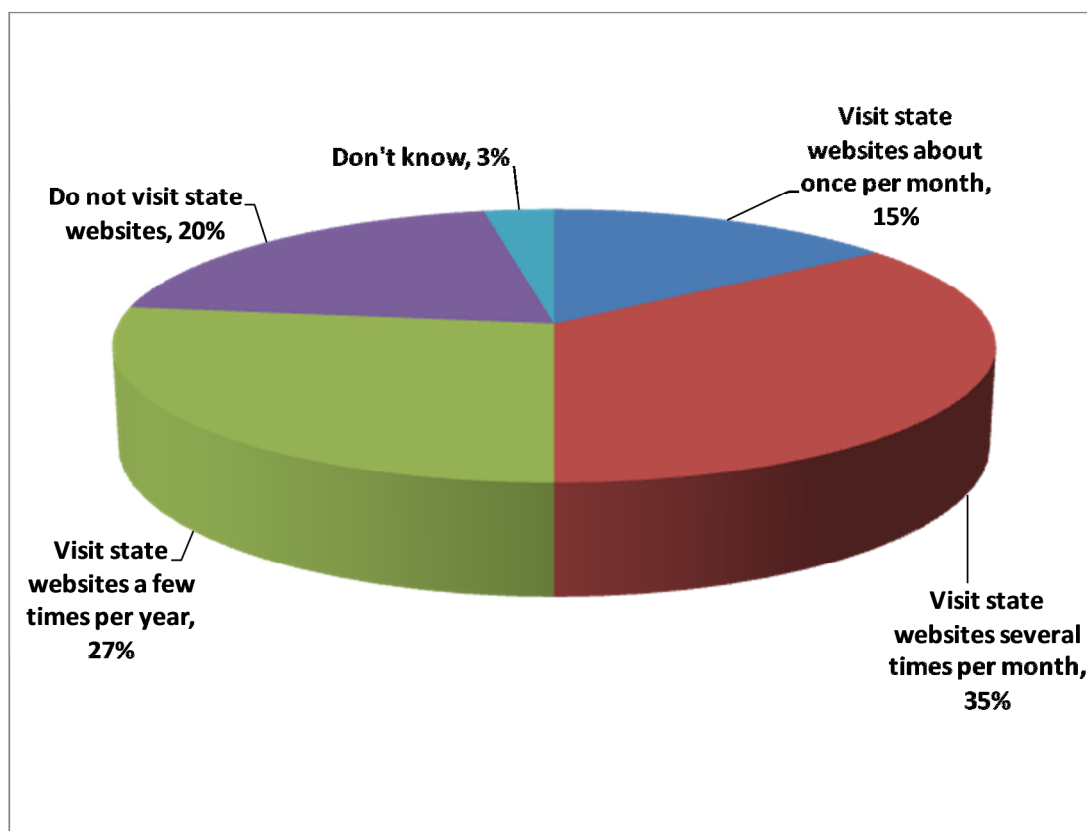

Source: Connect Florida, *Connect Florida Business Technology Overview*.

circumstances.

⁸⁹ Florida Department of Environmental Protection, *Progress Report*.

⁹⁰ See for example, Miami, http://miami.granicus.com/ViewPublisher.php?view_id=2, accessed February 28, 2010, where video files of meetings are available.

⁹¹ Florida Senate, “Video Broadcasts,” and Florida House of Representatives, “House Broadcasts.”

The Florida Department of Health uses Internet Protocol (IP)-based videoconferencing extensively at 400 sites statewide. Buildings with multiple video conference rooms can host multiple concurrent sessions all of which demand high bandwidth. Viewed from a point-to-point perspective, this is the single largest demand for broadband capacity for the Department. The MFN broadband network is used to transport the video data.⁹²

5.6.2 Online Records and Transactions

In addition to meetings, businesses and residents often need to access records and information maintained by state and local governmental units. For example, one of the projects recently recognized as a “Bright Idea” by the Harvard Kenney School’s Ash Center is Miami-Dade County’s online zoning records system. “Zoning Records Online is an innovative service that provides online access to zoning information and documents. Its functions offer services to county residents, improve the administration of records, help management with effective decision making, upgrade working conditions, enhance the level of citizen participation, and promote intergovernmental cooperation.”⁹³

5.7 Public Safety Interoperable Systems

Drivers of broadband utilization by government agencies include disaster recovery for government IT systems and data, use of Geographical Information System files, mobile broadband, and 700Mhz radio for public safety and related government functions. The nation’s first responders need an interoperable nationwide wireless broadband infrastructure to support state-of-the art data, video, and multi-media communications that is planned to be provided via 700Mhz radio.⁹⁴

The FCC’s National Broadband Plan recommends new funding, governance, and administrative practices to ensure the long-term health and interoperability of public safety communications. In the National Broadband Plan, the FCC describes a comprehensive online network for public safety workers linking police, firefighters and others. Developing the public safety network envisioned by the FCC will be very costly. “The total present value of the capital expenditure and ongoing costs over the next 10 years is approximately \$12-16 billion. State and local governments could contribute funds to cover some of these costs, and there may be additional cost-saving methods that reduce this estimate — such as sharing federal infrastructure, working with utilities, or use of state and local tower sites to improve coverage.”⁹⁵ At least one

⁹² Interview by David Brevitz and Herb Cash, Public Utility Research Center, University of Florida, with Bret Hart, Department of Health, December 14, 2010.

⁹³ Harvard University, “New Bright Ideas Recognizes Innovative Government.”

⁹⁴ Federal Communications Commission, *National Broadband Plan*, Broadband and Public Safety.

⁹⁵ Federal Communications Commission, *National Broadband Plan*, Chapter 16, Public Safety, quoting material preceding footnote 20.

jurisdiction in Florida, Charlotte County, has implemented next generation 911, which utilizes Internet protocol technology to enable the county’s public safety answering point to receive high-bandwidth files, such as digital photos and video, as well as text messages sent from wireless 911 callers.⁹⁶ (See Vol. II SD Sec. 19 for a more in depth discussion of public safety in Florida and elsewhere.)

5.8 Productivity Enhancement

Some applications that use high-speed networks to handle state government work efficiently may not be as visible as those discussed above, but are just as important to provide “back office” capability to public servants and other state residents. Many of those applications use networking services to increase efficiency and productivity. For example, a 2007 Government Accountability Office (GAO) report noted that Florida’s document management and imaging system used in the state’s food stamp program enabled caseworkers to retrieve electronic case records in seconds rather than hours.⁹⁷ Another application using mobile broadband is employed by Department of Children and Families case workers who use mobile devices for GPS capabilities and to upload pictures, biometrics and text files all with the date stamping associated with supervisory home visits, updating the case files in real time. This application is seen as providing big efficiencies and also significant “real time” data advantages. The Department of Children and Families collaborates extensively with the Florida Department of Law Enforcement (FDLE).⁹⁸

5.9 Telecommuting

Improved efficiency and other goals also can be achieved by enabling workers to telecommute. Florida is one of several states that created a procedure by which employees can work from home or other remote locations.⁹⁹ Similarly, federal agencies have been required since the early

⁹⁶ Bischoff, “Florida County Makes Transition to NG 911.”

⁹⁷ Federal Communications Commission, *National Broadband Plan*, Chapter 14, Government Performance, footnote 91 citing GAO, “Food Stamp Program.”

⁹⁸ Interview by David Brevitz, Public Utility Research Center, University of Florida, with Ramin Kouzehkanani, CIO, Department of Children and Families, November 8, 2010.; Interview by David Brevitz and Herb Cash, Public Utility Research Center, University of Florida, with Mark Zadra, Assistant Commissioner; Penny Kincannon, CIO; Mark Perez, Special Agent in Charge, Investigations & Forensic Science Program; Tal Whiddon, Inspector, Statewide Technical Operations, Investigations & Forensic Science Program; and Joey Hornsby; Florida Department of Law Enforcement, January 6, 2011.

⁹⁹ “Telecommuting is a work option that may improve employee performance, increase recruitment and retention of high performing employees, integrate into an agency’s Continuity of Operations Plan, and reduce office space requirements and energy consumption. In addition, telecommuting may provide a reasonable accommodation for an employee under the provisions of the Americans with Disabilities Act (ADA), may reduce transportation demand and save time and fuel. Let telecommuting work for you and your organization. If strategically designed, a telecommuting program has the potential to benefit both the employee and the employer.” Department of

1970s to give preference to rural locations for offices and other facilities. A 2003 progress report provided to Congress by the GAO finds that “technological barriers, such as the lack of access to high-speed Internet connections, could have a detrimental effect on the ability of some federal workers in rural areas to take advantage of telework.”¹⁰⁰

Telecommuting is important to some Florida businesses. The Connect Florida survey of 800 Florida businesses conducted between June 28 and August 12, 2010 as part of the SBDD project finds that 22 percent of the state’s businesses permit employees to telecommute, while 76 percent do not permit telecommuting.¹⁰¹ Results of the Connect Florida survey of state residents show that 46 percent of Internet users interact with their co-workers online and 23 percent report that they go online to work from home at least occasionally.¹⁰² The presentation of the survey’s key findings also note that “in Florida, 16% of employed adults report that they telework. Teleworking could also increase the state’s workforce, as one out of seven retirees, more than one-third of adults with disabilities, and more than two out of five homemakers and unemployed adults say they would likely join the workforce if empowered to do so by teleworking.”¹⁰³

5.10 Local Government Needs

Magellan Advisors and the South Florida Shared Fiber Initiative provide significant insight into the array of applications that are enabled by local broadband networking. (See Appendices II and III.) From Magellan Advisors:

Local governments are leveraging fiber networks now more than ever as their reliance on fast, secure, and always-on connectivity increases. These organizations are using these networks to transport data, voice and video traffic supporting various initiatives in the areas of public safety, utilities, wireless deployments, data sharing and collaboration with neighboring jurisdictions.

Management Services, *Telecommuting*, 1. See also Section 110.171, Florida Statutes. For information about other states, see National Conference of State Legislatures, *State Telecommuting Statutes*. See also National Conference of State Legislatures, *2010 Legislation on Telecommuting*, and National Conference of State Legislatures, *State and Regional Telecommuting Coordinating Agencies*.

¹⁰⁰ U.S. General Accounting Office, *Facilities Location*, 1. In the GAO testimony, working remotely was called “telework” and was described as follows: “Telework, also called telecommunicating or flexiplace, is a tool that allows employees to work at home or another work location other than a traditional office. Benefits of telework include reducing traffic congestion, improving the recruitment and retention of workers, and reducing the need for office space. Telework could allow federal workers who live in rural areas to work in or near their homes, at least some of the time.”

¹⁰¹ Connect Florida, *Connect Florida Business Technology Overview*, Slide 21.

¹⁰² Connect Florida, *Connect Florida Residential Technology Assessment*. The survey of 1,048 Florida Internet users was conducted by telephone between March 5 and April 5, 2010.

¹⁰³ *Ibid.*, Slide 53. Respondents to this question included 465 Florida residents 18 years of age or older, who were not employed full-time or part-time at the time of the survey, March 5 to April 5, 2010.

Municipal-owned fiber networks are providing a sense of “futureproofing” for the communities they serve in that the infrastructure deployed for today’s needs will support future initiatives. These networks are also driving down the cost of doing business for regions that take a collaborative approach to municipal fiber deployment. Cities, Counties and local anchor institutions are able to consolidate and purchase services such as Internet, voice, co-location, hosting, disaster recovery and other network services from one another and in some cases “cloud” based services such as e-mail, server virtualization and ERP applications. A list of the most common applications being supported on municipal fiber networks include:

- a) Public Safety
 - i) Video surveillance
 - ii) Computer aided dispatch (CAD)
 - iii) Records management
 - iv) Collaboration between agencies – local, state, federal
 - v) Wireless applications
- b) Public Works
 - i) Intelligent traffic systems – Timing/Signalization/Smart Signs
 - ii) Red Light Cameras/Speed Cameras
 - iii) Video traffic/route surveillance
 - iv) Emergency management
- c) GIS
 - i) Online plan submittal, review and approval
 - ii) Online GIS mapping
- d) Utilities
 - i) Water/Sewer/Electric Utility Communications (SCADA)
 - ii) Automated Meter Reading
 - iii) Smart Grid Applications
 - iv) Wireless applications
- e) Information Technology
 - i) General IT Services (WAN Communications)
 - ii) Voice Over IP
 - iii) Video
 - iv) Disaster Recovery
 - v) Infrastructure Sharing
 - vi) Emergency Management
 - vii) Wireless applications

Results from the Local Broadband Inventory survey show that there is a significant use of broadband communications networking by cities for control of electric utility operations (e.g., Lakeland, Ocala, Gainesville, and Tallahassee). Traffic control/ITS is a prevalent use of fiber optic communications networking by cities and counties. See Vol. II SD Appendix I.

6 Florida’s Legal Framework

In this section, we describe Florida’s legal framework for planning and implementation of its enterprise telecommunication network and the technical characteristics of the three statewide networks serving Florida anchor institutions. Our discussion also draws upon the insights from our analysis comparing Florida to other states. Below is a summary of the laws governing SUNCOM. In Section 9, in the context of governance, we summarize the statutes governing AEIT.

6.1 Florida Communication Information Technology Services Act¹⁰⁴

The Communication Information Technology Services Act establishes the SUNCOM Network¹⁰⁵ (Network), defines the responsibilities of the Department of Management Services (DMS)¹⁰⁶ relative to the Network, and designates public and private entities that may use the Network. In addition, the Act defines the DMS’s responsibilities for the State Agency Law Enforcement Radio System, mutual aid channels, interoperability network and statewide regional law enforcement communications system.

The SUNCOM Network is established “as the state enterprise telecommunications¹⁰⁷ system for providing local and long-distance communications services to state agencies,¹⁰⁸ political

¹⁰⁴ Questions about interpretation or applicability of these or other provisions of Florida law should be directed to competent legal counsel. The Act is codified at sections 282.701 – 282.711, Florida Statutes. Statutes cited were accessed at <http://www.leg.state.fl.us/statutes/>. Session laws cited were accessed at <http://laws.flrules.org/>. Note that definitions used in the Act are codified at Section 282.0041(1) Florida Statutes.

¹⁰⁵ “SUNCOM Network” is defined to mean “the state enterprise telecommunications system that provides all methods of electronic or optical telecommunications beyond a single building or contiguous building complex and used by entities authorized as network users under this part.” Section 282.0041(25), Florida Statutes. In this summary, the statutory and more inclusive term, SUNCOM, will be used. In practice, SUNCOM is used to refer to the portfolio of services that DMS offers through the Division of Telecommunications. SUNCOM services are identified on the DMS website at: <http://dms.myflorida.com/suncom>.

¹⁰⁶ The Department of Management Services is created as a department of the Executive Branch of Florida state government by Section 20.22, Florida Statutes. The authorizing statute establishes the Secretary of Management Services as the head of the Department. The Secretary is appointed by the Governor, subject to confirmation by the Senate, and serves at the pleasure of the Governor. Statutory programs of the Department include: Facilities, Technology, Workforce, Support, Federal Property Assistance and Administration. Statutory Divisions include Administrative Hearings, Retirement, and State Group Insurance. The section creating the Department and establishing its programs and divisions was last amended by s. 2, ch. 2007-105, Laws of Florida.

¹⁰⁷ “Telecommunications” is defined to mean “the science and technology of communication at a distance, including electronic systems used in the transmission or reception of information.” Section 282.0041(26), Florida Statutes. Among the telecommunications services provided by the Department are data transport services which collectively are called MyFloridaNet. Service elements that comprise MyFloridaNet include network core, local loop access, customer premises equipment, security, network management tools, design and engineering, among others. See Department of Management Services, “SUNCOM Products and Pricing.”

¹⁰⁸ “Agency” is defined to mean “any official, officer, commission, board, authority, council, committee, or

subdivisions of the state, municipalities, and nonprofit corporations . . .”¹⁰⁹ The Network must be able to transmit all types of telecommunications signals. State agencies are required by the Act to cooperate and assist in development and use of telecommunications systems and services. The statutes comprising the Act are summarized in greater detail in Vol. II SD Sec. 14.

The Department must “design, engineer, implement, manage, and operate through state ownership, commercial leasing, contracted services, or some combination thereof, the facilities, equipment, and contracts providing SUNCOM Network services, and . . . develop a system of equitable billings and charges for telecommunications services.”¹¹⁰ All Executive Branch agencies, except state universities¹¹¹ and FDOT (for traffic control devices only),¹¹² must use the Network; “however, an agency is not relieved of responsibility for maintaining telecommunications services necessary for effective management of its programs and functions.”¹¹³

If an agency determines that a Network service does not meet its needs, the agency is required to notify the Department in writing and describe its service requirements. If the Department cannot meet an agency's requirements, it may grant the agency an exemption from use of the Network. Other than the case-by-case exemption procedure, state universities are the only class of state agencies whose use of SUNCOM is discretionary.

6.1.1 Use of State SUNCOM Network by Municipalities

Any municipality may request from the Department any or all of the Network's services, on terms established by the Department. Any municipality that utilizes the Network is billed by DMS for the municipality’s “share of installation and recurring costs according to the published

department of the executive branch of state government. . . .” Section 216.011(1)(qq), Florida Statutes. The definition does not encompass the Legislative and Judicial Branches. For purposes of Chapter 282, the definition also excludes university boards of trustees and state universities. Section 282.0041(1) Florida Statutes.

¹⁰⁹ Section 282.703(1), Florida Statutes.

¹¹⁰ Section 282.703(2), Florida Statutes.

¹¹¹ Prior to the 2002 amendment of the Act, state universities were not explicitly included as participants in the SUNCOM Network, nor required to use SUNCOM services. However, they appear to have been subsumed under the definition of “state agency” in Section 216.011, Florida Statutes, as part of the Executive Branch. State universities were explicitly added to the requirement to use SUNCOM by Chapter 2002-387, Laws of Florida. The most recent amendment of the Act by the 2010 Legislature (Chapter 2010-148, Laws of Florida) repealed the requirement that universities and university libraries use the SUNCOM network. The Department is authorized to provide services to a state university if requested to do so by a university.

¹¹² The pertinent subsection follows: “Computerized traffic systems and control devices which are used solely for the purpose of motor vehicle traffic control and surveillance shall be exempted from the provisions of chapter 282.” Section 335.14(2), Florida Statutes.

¹¹³ Section 282.703(3), Florida Statutes.

rates . . . and as invoiced by the department.”¹¹⁴

6.1.2 Use of State SUNCOM Network by Nonprofit Corporations

The Department must provide a means by which certain private nonprofit corporations may use the SUNCOM Network. An eligible nonprofit corporation must spend the majority of its direct revenue to provide contractual services to the state, a municipality or a political subdivision and receive only a small portion of its total revenue from any other source during the time SUNCOM Network services are requested. Nonprofit corporations established by law and an association of municipal governments that is wholly owned by the municipalities are also eligible to use the SUNCOM Network. Private, nonprofit elementary and secondary schools that have an endowment of \$50 million or less are eligible for rates and services on the same basis as public schools.

6.1.3 Use of SUNCOM Network by Libraries

The Department may provide SUNCOM Network services to any library in the state. The statute specifically states that it is not to be interpreted to require a state university library to use SUNCOM Network services.

6.1.4 State Agency Law Enforcement Radio System and Interoperability Network

The Department may acquire and administer a statewide radio communications system (System) to serve law enforcement units of state agencies and local law enforcement agencies through mutual aid channels. The Department is responsible for the design, engineering, acquisition and implementation of the System and for ensuring the proper operation and maintenance of shared System equipment. The Department is authorized to create and administer an interoperability network to enable interoperability between various radio communications technologies. The Department is also charged with planning, managing and administering the mutual aid channels in the System.

¹¹⁴ Section 282.704, Florida Statutes.

7 Description of Florida’s State Broadband Networks

7.1 MyFloridaNet (MFN)

SUNCOM is a portfolio of voice, data and other telecommunications services provided by DMS’s DivTel for use by state and local government. Provision of SUNCOM services dates back to 1973. One of the newest services, MFN, fills most broadband data communication needs of eligible users. MFN is the latest step in an evolution of data transport networking that began in 1987 with the deployment of T1 digital backbone facilities for transport of data communications and other state communications. MFN is competitively procured by DMS under contract, with AT&T as the prime contractor. AT&T has subcontracts for particular functions (e.g., Network Operations Center from CenturyLink) and geographical areas (e.g., other provider territories including CenturyLink and Verizon). MFN is thus an outsourced network. The contract for MFN services was extended and renewed for an additional five years on December 28, 2010.¹¹⁵ DMS has estimated initial annual savings from the rate reduction associated with the extension as \$2.2 million. The design of the rate reductions facilitates migration to higher bandwidth services. Additional information about the network can be found in Vol. II SD Sec. 14.3 and 16.2.

MFN is a Multi-Protocol Label Switching (MPLS) capable IP network, which has a scalable statewide footprint. MFN provides improved security and robust connectivity resulting in a highly available and highly reliable statewide communication network. According to DMS, “The MyFloridaNet network platform provides a very flexible, highly available and secure communications infrastructure especially designed to satisfy the growing demands of our customers’ high availability, multimedia capable and security sensitive applications.”¹¹⁶ The high reliability and high availability of MFN is backed up by a strict Service Level Agreement (SLA).¹¹⁷ The SLA includes service restoral to the individual customer in the stated window, rather than basing it on averages. A number of agency-critical applications are supported over MFN, which can be seen in Vol. II SD Appendix IV.

MFN network users order two network service elements: the port (network core access) and the local loop. Those two elements are charged on a flat rated, month-to-month basis. The MFN core port for all local loop access types is a flat monthly rate, with the rate increasing based on speed/bandwidth. Local loop access is flat monthly rate statewide, with published rates for all

¹¹⁵ *Amendment 5 to MyFloridaNet Contract, 1.*

¹¹⁶ Department of Management Services, “Data Transport Services.” For a full list of MFN features, see Ghini, *Renewal versus Rebid of the MyFloridaNet Contract*, Attachment 9.

¹¹⁷ *MyFloridaNet Contract*; See Section 4.3.17 “Service Levels,” Section 4.3.18 “Receive Alerts and Service Credit Processes,” Section 4.4.13 “Performance Tools,” and Exhibit 2 which contains each Service Level Agreement and the related performance target, liquidated damages and measurement.

bandwidths up through 1 Gbps. The agency has options regarding how it procures customer premises equipment associated with MFN. MFN service includes security, network management tools, design, and engineering. MFN provides end-to-end services, including Internet services and quality of services enforced by service level agreements.

DMS’s MFN costs are recovered from the above rates charged to agency users. The rates cover the direct vendor costs of the service plus an allocated share of DMS’s costs associated with staffing, office space and related support costs. There is no direct legislative appropriation for MFN costs—instead MFN costs are covered by legislative appropriations for the individual agencies.

Through an arrangement referred to as “competitive access,” the MFN contract provides for customers to obtain the access component from a provider other than the MFN provider. This provision is explained in more detail at Vol. II SD Sec. 14.3.4, DMS is currently exploring the use of NFBA for competitive access with AT&T. Reduced port prices for Metro Ethernet via the MFN contract extension makes competitive access opportunities more economical.

Interviews with DMS and other agencies suggest that the variety of MFN network access choices will continue to expand, such as mobile communication devices, including 4G (LTE or Long Term Evolution) for agencies and for public safety. Also, use of Remote Broadband Service (RBS) is being validated by DMS for use as an MFN access option, in addition to its current use for providing DSL connections for small government office locations. DMS is taking necessary steps to enable RBS to be used for connection to MFN in lieu of the local access element. Use of RBS will enable suitable locations to obtain MFN connection at higher speeds and one third the cost of a T-1 (1.544 Mbps) MFN connection.

7.2 Florida LambdaRail (FLR)

FLR is the statewide research and education network in Florida. FLR’s network is designed to reach all Florida’s public or private, nonprofit educational or research organizations, and thus is statewide. Affiliates are able to connect through the state universities or directly at other nodes in the network.

FLR has been in “full production” for more than five years. FLR’s services include high-speed fiber optic network services, which include dedicated wavelengths, network peering, network aggregation services, IP transit between participants, connectivity to advanced regional and national networks, a form of bandwidth management referred to as “dynamic bandwidth allocation,” and connectivity to commercial Internet Service Providers.¹¹⁸

Funding comes from 12 Florida research universities that are Equity members and from affiliate

¹¹⁸ Florida LambdaRail, *Bi-Annual Report*, 4.

organizations. Equity members include: Florida Atlantic University, Florida Gulf Coast University, Florida International University, Florida Institute of Technology, Florida State University, Nova Southeastern University, University of Central Florida, University of Florida, University of Miami, University of North Florida, University of South Florida, and University of West Florida. Affiliates include not-for-profit private universities, other state universities, several community colleges, the Florida College Center for Library Automation, the Northwest Regional Data Center, the Florida Department of Education, Orange County, Orange County Public School District via Education Networks of America, Palm Beach County, and several research and medical institutes. FLR receives no direct state funding through the appropriation process and has received no federal stimulus funding as of November 12, 2010.¹¹⁹ Participant payments for use of FLR services are due and payable on a quarterly basis.

FLR is what is referred to as a “regional optical network,” one of 25 such networks in the nation.¹²⁰ At the regional level, FLR participates through a consortium of southeastern states, the Southeast Regional Optical Networks committee of Southern Universities Research Association. At the national level, FLR participates in Internet2, National LambdaRail, StateNets of EDUCAUSE, and the Quilt Consortium for Research and Education Networks Cooperation. As a member of Quilt, FLR obtains Internet service for its members at a discounted rate.¹²¹ At the international level, FLR participates in the Global Lambda Integrated Facility.¹²²

The FLR operates as a virtual organization in many ways. Authority and oversight is centralized and invested in a Board of Directors augmented by the necessary delegations of authority and operational management required to effectively and efficiently conduct operations. Support services (e.g., administrative, financial, legal, and network operations) are contracted services from Equity member institutions.¹²³

FLR obtains Network Operations Center functions under contract with the University of Florida, with about five full-time equivalent employees. There is no need for further network staff since FLR operates the backbone network, while participants are responsible for “last mile” connectivity and customer premise equipment. The network is operated without strictly defined quality of service objectives enforced by a Service Level Agreement, but FLR supports the

¹¹⁹ Florida LambdaRail collaborated on a SmartNet proposal with others but it was not funded. According to Veronica Sarjeant, COO, Florida LambdaRail, if the grant had been awarded, it would have opened up points of presence for Florida LambdaRail. Interview by David Brevitz (via teleconference), Lynne Holt, Mary Galligan, Narongpol Chotset, Public Utility Research Center, University of Florida, with David Pokorney, Phil Halstead (via teleconference), Veronica Sarjeant (via teleconference), Florida LambdaRail, Gainesville, November 12, 2010. For information on SmartNet, see Florida College System, *Florida Smart Net*.

¹²⁰ Florida LambdaRail, *Bi-Annual Report*, 7.

¹²¹ *Ibid.*, 15.

¹²² See *Ibid.*, 4 for participation at the regional and national levels, and p. 5 for reference to global participation.

¹²³ Veronica Sarjeant. Written communication to David Brevitz. January 14, 2011.

quality of service protocol. However, with FLRNet’s 20Gbps over-provisioned backbone, quality of service has not been a requirement or requested to-date by its membership.¹²⁴

Additional information about FLR’s services, members, and a topology map of the network are included in Vol. II SD Sec. 14.4.

7.3 Department of Transportation’s Intelligent Transportation System (ITS)

“Intelligent Transportation Systems (ITS) represent the application of technologies involving information processing, communications, control, and electronics to improve our transportation system by saving lives, time, and money.”¹²⁵ ITS depend upon extensive communications networking, especially fiber optic facilities and related electronics and structures. ITS projects are planned, constructed/deployed and managed by FDOT districts on a geographic basis and the Florida Turnpike Enterprise. The ITS Program in the Traffic Engineering and Operations Office at FDOT administers ITS policies and procedures. Each of the seven FDOT districts plus the Turnpike Enterprise has management authority to build and operate facilities in its district, using funding obtained from FDOT under the ITS Program, with limited ITS-specific responsibilities; the FDOT ITS Program establishes funding levels by year and appropriates funds to the districts. District management has operational authority within the individual districts under policies and procedures established by the FDOT ITS Program. The districts use Regional Transportation Management Centers (RTMC) as part of the management organization structure. Each district manages the network by itself with RTMCs. Districts 1 and 4 and the Florida Turnpike Enterprise use SunGuide ® software in their network management.¹²⁶

FDOT and its districts have deployed substantial fiber optic communications networking throughout the State of Florida using federal ITS funding, although there are areas without fiber optics (*e.g.*, I-10 corridor and I-75 from Tampa north to the Georgia state line¹²⁷) where microwave radio transmission networking is used. FDOT has connected two district networks via Wide Area Networking. FDOT’s current ITS plan covers deployment on 1,260 miles of

¹²⁴ Veronica Sarjeant. Written communication to David Brevitz. January 14, 2011.

¹²⁵ Intelligent Transportation Society of Florida, *ITS Florida*.

¹²⁶ Florida Department of Transportation, *Intelligent Transportation Systems Program Annual Report Fiscal Year 2009-2010*, 6. SunGuide ® software is used by regional transportation management centers “to monitor and control traffic monitoring devices and record traffic and event conditions on a 24/7/365 basis.” “Beyond traffic management functionality, RTMC operators can use SunGuide to report conditions directly to FL-ATIS, thereby informing the traveling public.” Additional Districts will be implementing SunGuide ® as well. *Ibid.*, 19.

¹²⁷ Florida Department of Transportation, *Intelligent Transportation Systems Program Annual Report Fiscal Year 2008-2009*, 12. Fiber for these routes was not in the 5 year work program as of 2009 per FDOT, and is not on the planning horizon at this time.

freeway (60 percent) by 2014.¹²⁸ According to FDOT, “At the end of June 2010, over 1,100 miles of limited-access roadways had ITS deployments (54 percent of the limited-access Florida Intrastate Highway System); however, we have rural interstates on which ITS infrastructure has not been deployed. We explored and found alternate data collection sources to feed information into our statewide 511 advanced traveler information system; thereby, enhancing information provided to travelers in rural areas of our state.”¹²⁹ According to FDOT, “FDOT intends to invest approximately \$929 million between 2002 and 2020.”¹³⁰

FDOT ITS has begun a Video Aggregation System (VAS) Phase II project that will make full motion video available to the public through the FL511.com website.¹³¹ VAS is part of Florida’s Advanced Traveler Information System (FL-ATIS). VAS “provides the public with access to images from FDOT’s statewide closed-circuit television (CCTV) cameras. Counting the seven FDOT districts, Florida’s Turnpike Enterprise, Miami-Dade Expressway Authority, and the Orlando-Orange County Expressway Authority, there are about 1,600 CCTV cameras available for distributing images. FDOT anticipates that this number will expand to more than 2,000 CCTV cameras in the next few years. VAS II will utilize the ITS wide area network.”¹³²

7.3.1 ITS Networking

Fiber optic communication technology supports ITS. Our review of facility maps indicates FDOT ITS has deployed from 24 to 96 fiber strands when implementing the network, depending on the location. To provide an idea of comparative scale, FDOT currently operates 90,353 strand miles of fiber optic cable (which does not include County ITS facilities), while in contrast FLR operates 3,080 strand miles (1,540 miles times two strands, which does not include member or affiliate local access connections). Research conducted for this project indicates counties have deployed extensive ITS networking as well.

7.3.2 “Highway Purposes” Policy Requirement and Implications

The ITS fiber optic communications networking is discussed separately from other Florida broadband networks for two reasons. First, ITS is designed for a specific purpose-traffic

¹²⁸ Intelligent Transportation Society of Florida, *Intelligent Transportation Systems*.

¹²⁹ Florida Department of Transportation, *Intelligent Transportation Systems Program Annual Report Fiscal Year 2009-2010*, 1.

¹³⁰ *Ibid.*, 2.

¹³¹ *Ibid.*, 5. VAS Phase I disseminated still images.

¹³² Florida Department of Transportation, *Intelligent Transportation Systems Program Annual Report Fiscal Year 2009-2010*, 21. The vendor selected plans to use Qwest data circuits obtained outside MFN if the ITS Wide Area Network is not available as needed. Interview by David Brevitz and Herb Cash, Public Utility Research Center, University of Florida, with Elizabeth Birriel, ITS Program Manager, Florida Department of Transportation; Randy Pierce, Telecommunications Program Manager, Florida Department of Transportation; and Frank Deasy, Program Manager and General Telecommunications Consultant, Florida Department of Transportation; November 30, 2010.

management-and therefore has more characteristics of a cabling plan than full-blown communications networking. This conclusion is drawn from review of facility maps provided by FDOT,¹³³ that show that the ITS networking does not have a ring¹³⁴ or other topology characteristic of communications networks. However, FDOT is using ITS facilities to develop Wide Area Networking (WAN) capabilities for its internal use, and to support the Video Aggregation System.¹³⁵ Second and relatedly, we learned during the course of this study that, absent a waiver from the Federal Highway Administrator, the fiber optic facilities included in the ITS cannot be used by other users beyond transportation traffic management purposes. The federal statutes cited by the Department of Transportation as restricting use of ITS facilities to “highway purposes” and provide provision for waiver are as follows:¹³⁶

U.S.C. Title 23, Section 1.23(b) *Use for highway purposes*. Except as provided under paragraph (c) of this section, all real property, including air space, within the right-of-way boundaries of a project shall be devoted exclusively to public highway purposes.

U.S.C. Title 23, Section 1.23 (c) *Other use or occupancy*. Subject to 23 U.S.C. 111, the temporary or permanent occupancy or use of right-of-way, including air space, for non-highway purposes and the reservation of subsurface mineral rights within the boundaries of the rights-of-way of federal-aid highways, may be approved by the Administrator, if he determines that such occupancy, use or reservation is in the public interest and will not impair the highway or interfere with the free and safe flow of traffic thereon.

Policies and practices of the FDOT were identified during this study by a number of stakeholders as significant barriers to cost-effective use of fiber optic network facilities for ITS.¹³⁷ There is a widespread interest among local jurisdictions, DMS, and FLR in leveraging FDOT fiber optic

¹³³ These facility maps are not considered to be “public records,” and were reviewed under a commitment to not disclose or release the facility maps but to only view them for purposes of this project. FDOT states the facility maps are considered confidential and released on a “need to know” basis only and shall not be disclosed and/or released under Florida Statute F.S. 119.071(3).

¹³⁴ A ring architecture permits traffic to be rerouted almost instantly if a fiber cut were to occur.

¹³⁵ Interview by David Brevitz and Herb Cash, Public Utility Research Center, University of Florida, with Elizabeth Birriel, ITS Program Manager, Florida Department of Transportation; Randy , Telecommunications Program Manager, Florida Department of Transportation; and Frank Deasy, Program Manager and General Telecommunications Consultant, Florida Department of Transportation; November 30, 2010.

¹³⁶ Questions about interpretation or applicability of these or other provisions of Florida or federal law should be directed to competent legal counsel.

¹³⁷ DMS also sees these policies and practices as making any underutilized capacity which might exist “unavailable to SUNCOM or for other government purposes.” Department of Management Services, *Division of Telecommunications Business Model*, 54.

capacity to the extent allowable. As described above, use of ITS communications networking is, in the absence of a waiver, restricted to “highway purposes” by federal statute under which the federal funds are provided to construct the ITS.¹³⁸

7.4 Barriers for State Agencies

State agency managers who were interviewed for this study expressed satisfaction with MFN and its implementation: MFN has simplified IT management for agency managers so that their resources can be focused on other activities important to their agency mission. In addition, in some instances MFN use has resulted in reduced agency costs (for example FDLE) when compared to costs associated with previous data networking arrangements.

However, there are situations where broadband deployment is cost prohibitive, such as rural, isolated areas. While many agencies are not affected by this, two agencies in particular are: the Florida Fish and Wildlife Conservation Commission (FWC) and the Department of Corrections (DOC). Both agencies have locations in rural, isolated areas where telecommunications facilities are not ordinarily placed, based on commercial considerations.

FWC has remote offices with few employees primarily in rural areas where broadband is needed but costly to provide. Currently, some of those facilities receive data services via satellite, but that service is not satisfactory due to delay, etc. At these remote locations, there is little need for all the bundled features of services provided by MFN. FWC believes it would be difficult at best to cost justify placement of a T-1 1.544 Mbps MFN connection at these remote locations. As one of the Commission’s employees observed, the bundled features are not worth the extra “\$400 per month”¹³⁹ for the needs of a remote location such as this. DMS is developing an economical alternative for circumstances like this, which will also be available for other locations, with its RBS. This service is essentially a DSL connection to the MFN, and will offer higher speeds at a much lower price. See Vol. II SD Sec. 14.3.5 for a fuller description of RBS.

DOC, most of whose 70 locations are intentionally in remote locations, stated that high speed Ethernet connections are unavailable at many of its locations¹⁴⁰ because provider facilities are unavailable. As a result the department is using frame relay at those locations. According to DMS, Ethernet is available and many of the DOC locations where the department is using frame relay, so there is a possibility that DOC may be upgrading soon at those locations. However, there are locations where Ethernet will not be available in the near future or is costly to access.

¹³⁸ As our modeling shows, for other governmental entities to use the FDOT fiber economically it would need to be the case that FDOT’s network is underutilized.

¹³⁹ Interview by David Brevitz and Herb Cash, Public Utility Research Center, University of Florida with Kevin Patten, Office of Information Technology, Florida Fish and Wildlife Commission, September 8, 2010.

¹⁴⁰ Interview by David Brevitz, Mark Jamison and Herb Cash, Public Utility Research Center, University of Florida with Sherry Sellers, Network Administrator, Department of Corrections, December 2, 2010.

The DOC Regional Medical Center at Lake Butler is an example of these situations: At that location DOC is unable to obtain greater bandwidth because of cost considerations and unavailability of Ethernet. Satellite and wireless solutions have been tried but do not work properly for the appropriate applications, such as images and charts for electronic medical records. In general DOC is increasing its use of bandwidth and computer storage capacity. For example, DOC is scanning inmate paper records to reduce floor space record storage costs. Upgrading of sites to Ethernet would make broadband capacity cheaper for this use.¹⁴¹

There are at least three other options that may be available in some cases, two of which would likely be limited in rural areas as well. Mobile broadband may be useful in serving isolated rural locations. However, availability of mobile broadband is also affected by the cost considerations that drive placement of network facilities, such that cellular network coverage is not available or robust in all locations, particularly in rural areas. We also note that the MFN contract provides competitive carrier access. Although this may be a solution for some agencies, it is also likely to have limited applicability in solving rural access issues. The competitive carrier access provision of the contract is relatively new and has not yet been exercised, but DMS is exploring its use with AT&T and NFBA/FRBA.¹⁴² Another possibility is emerging WiMax solutions, such as those being deployed by some water management districts. For example, the South Florida Water Management District is installing WiMax in its area. This would be a workable solution for FWC needs at remote locations in the South Florida Water Management District coverage area.¹⁴³

An existing option for state agencies that have difficulty accessing MFN service exists in Florida law. DMS is authorized to grant exemptions from the requirement for agencies to use MFN services. We found only one agency request for exemption.

7.5 Barriers for Health Care

Although implementing electronic medical records and related changes will expand the use of broadband-supported applications in the healthcare industry, affordability of broadband service may present a barrier to implementing those applications in rural areas. Indeed, cost may be a larger barrier than lack of access to broadband facilities and services.¹⁴⁴ As shown in Table 7-1,

¹⁴¹ Interview by David Brevitz, Mark Jamison and Herb Cash, Public Utility Research Center, University of Florida with Sherry Sellers, Network Administrator, Department of Corrections, December 2, 2010.

¹⁴² Regional networks such as the North Florida Broadband Authority and Florida Rural Broadband Alliance may provide solutions to serve more isolated, rural locations by virtue of their federal subsidies. Greater clarity will be gained on the applicability of these networks to directly address connectivity for FWC and Corrections by Second Quarter 2012 as planned networks are built out, and DMS, AT&T and NFBA/FRBA explore implementation considerations.

¹⁴³ Ibid.

¹⁴⁴ Interview by David Brevitz, Public Utility Research Center, University of Florida, with Dr. Christopher Sullivan,

which is taken from the draft 2010 environmental scan prepared by the WellFlorida Council, Inc., only 73 (2.8 percent) of more than 2,500 eligible professionals who responded to the survey have no internet connection.¹⁴⁵

Table 7-1. WellFlorida Council Survey of Internet Access, 2010

What Type of Internet Access (If Any) Does Your Practice Location Currently Have?		
Form of Internet Access	Number	Percent
No Internet access	73	2.8%
Dial-up	22	0.9%
DSL#1	1,203	46.8%
Cable #2	561	21.8%
Satellite	6	0.2%
T-1 #3	358	13.9%
Fiber optic cable	222	8.6%
Mobile data plan-wireless carrier	21	0.8%
Other	16	0.6%
No response	89	3.5%
TOTAL	2,571	100.0%

Source: WellFlorida Council, Inc., Florida Health Information Technology Environmental Scan, Table 8, p. 22.

Attempts to address the affordability issue at the federal level have not been widely successful. For example, FCC’s Rural Healthcare Pilot Program made available \$450 million in 2006 from the Universal Service Fund but only a quarter of it has been spent. The low take-up rate was apparently due to restrictions such as the program will not pay for management, there is a required match which providers cannot meet, and only non-profits may participate.¹⁴⁶ Another concern is whether wireless networks will be sufficiently secure to encrypt transmitted healthcare

Ph.D., Administrator; Florida Center for Health Information and Policy Analysis, August 12, 2010.

¹⁴⁵ WellFlorida Council, Inc., *Florida Health Information Technology*.

¹⁴⁶ Ibid.

applications, such as electronic records. Encryption is a requirement of Health Insurance Portability and Accountability Act (HIPAA) of 1996 (P.L.104 -191). Yet another issue to be addressed is the standardization for interfacing electronic medical records. Currently, there is no such standardization and it is costly to enable the electronic records to communicate with each other.¹⁴⁷ In short, electronic medical records will change the practice of healthcare. However, certain barriers to their widespread use and to those of other electronically transmitted healthcare-related applications remain, particularly for healthcare providers in rural regions, including those in the counties to be served by the NFBA and Florida Rural Broadband Authority.

¹⁴⁷ Ibid.

8 Florida Local Government Networks

8.1 Florida Law Impacting Municipal Networks

One constitutional provision and two statutes governing municipal telecommunication services were referenced during discussions and interviews conducted for this study. Article VIII, Section 2(b) of the Florida Constitution establishes the municipal home rule and sections 166.047 and 350.81, both Florida Statutes, address telecommunication services provided by municipalities or other governmental entities.¹⁴⁸ A more detailed summary of these and related provisions of Florida law can be found in Vol. II SD Sec. 15.1.

8.1.1 Article VIII, Section 2(b), of the Florida Constitution

The Florida Constitution establishes the framework for municipal home rule:

Municipalities shall have governmental, corporate and proprietary powers to enable them to conduct municipal government, perform municipal functions and render municipal services, and may exercise any power for municipal purposes except as otherwise provided by law...

According to an explanation of the constitutional provision in the *Florida Municipal Officials' Manual* published by the Florida League of Cities, “before [the Constitution was amended in] 1969, a municipality could do only those things which it was **clearly authorized** to do . . . after 1969, a municipality may do **anything** which it is **not prohibited** from doing.” (emphasis in original)¹⁴⁹

The Municipal Home Rule Powers Act, enacted in 1973, is codified at Chapter 166, Florida Statutes. The Act includes a definition of “municipal purposes” that is used but not defined in the Constitution. By law, those purposes are “any activity or power which may be exercised by the state or its political subdivisions.”¹⁵⁰

Also, as described in the League of Cities publication, “in decisions since 1973, the Supreme Court has consistently respected the home-rule principle. . . The Legislature is ultimately supreme, still, in that it may restrict the powers of municipal self-government by erecting specific prohibitions. Absent such prohibitions, however, municipal officials may exercise any

¹⁴⁸ Provisions of Florida law are summarized here for ease of reference. Questions about interpretation or applicability of these or other provisions of Florida law should be directed to competent legal counsel. Statutes cited were accessed at <http://www.leg.state.fl.us/statutes/>. Session laws, Laws of Florida, cited were accessed at <http://laws.flrules.org/>. Accessed September 2010.

¹⁴⁹ Florida League of Cities, *Municipal Officials' Manual*, 8

¹⁵⁰ Section 166.021(2), Florida Statutes.

power, so long as it be for a municipal purpose.”¹⁵¹

Section 166.047 of the Florida Statutes authorizes municipal telecommunications companies to obtain or hold a certificate pursuant to Chapter 364, Florida Statutes. Obtaining a certificate is specifically designated as serving a municipal or public purpose under conditions enumerated in the statute. The conditions include separate accounting for revenue and expenses associated with the services, imposition of the same local regulations on the municipal companies as applied to other telecommunication companies, and payment of ad valorem taxes.

Section 350.81 of the Florida Statutes creates procedures and certain operating conditions for counties, cities or other specified governmental entities that sell cable or telecommunication service, including wireless services.¹⁵² The services cannot be subsidized by other revenue to make price of the service below the cost. Record keeping requirements and restrictions are specified in the statute. A governmental unit may not use its power of eminent domain solely or primarily to provide a communication service. Governmental entities are authorized by the statute to issue revenue bonds to finance capital costs for the service.

8.2 Description of Local and Regional Networks

Our research and analysis shows that numerous cities and counties have deployed and are operating fiber optic and wireless broadband networks to meet communications networking needs between locations. Among the major findings of this study is the extent of networking that has been developed by local authorities (cities, counties, county ITS, and regional groups). While a significant focus for this research was statewide broadband networks, local and regional broadband networks were the subject of research as well. Work on the project revealed a number of local networks or “broadband exchanges” that have developed to meet operational needs of local units of government. “There is a vast amount of municipally owned fiber network throughout the State of Florida, owned and operated by cities, counties, school districts, constitutionals, public safety organizations and utilities. In many cases, network assets are suitable and available to provide last-mile resources to commercial service providers or to other municipal organizations directly.”¹⁵³ The local governments are seeking budget savings and efficiency. Magellan Advisors and the South Florida Shared Fiber Initiative describe the array of applications that are enabled by local broadband networking. (See Appendices II and III.)

Collaboration between jurisdictions appears to be increasing in frequency and expanding to encompass shared collaborative use of communications networks and ITS/traffic management facilities to save on budgets. IT applications serving government are clearly important, but

¹⁵¹ Florida League of Cities, *Municipal Officials’ Manual*, 8

¹⁵² Specific definitions of those services are at Section 350.81(1).

¹⁵³ Magellan Advisors, LLC, *Local Government Communications Use*, Appendix II.

budget savings are attractive. Palm Beach County ITS and Palm Beach County Information Systems Services reached a collaborative agreement in January 2011. This could be significant because, as described earlier, ITS networks are restricted to “highway purposes,” absent a waiver, and Palm Beach County believes it has solved this issue to permit collaboration and sharing of network facilities between ITS and Information Systems Services.

We derived additional information about city and county broadband networking from documents provided by cities and counties, as well as Local Broadband Inventory survey work done in 2009 and 2010. The 2009 survey was developed and conducted by DMS in Summer 2009, in which it surveyed Florida cities and counties about broadband network inventory. The 2010 survey was conducted by Magellan Advisors under PURC auspices to extend and update the 2009 DMS survey. Magellan Advisors conducted the survey online. Further detail on this work is contained at Vol. II SD Sec. 15.3 and Appendices I and II.

In this report, we focus on several examples of local broadband network developments.

8.2.1 Gainesville Regional Utilities/GRUCom

Gainesville Regional Utilities represents an innovative local government approach to broadband deployment. The City of Gainesville, Florida owns and operates a combined utility system, GRU. GRU provides five separate utility functions: an electric generation, transmission and distribution system (Electric System); water production and distribution system (Water System); a wastewater collection and treatment system (Wastewater System); a natural gas distribution system (Gas System); and a telecommunications system, GRUCom. GRUCom is the largest and most comprehensive municipally owned telecommunications service provider in the State of Florida.

GRUCom has operated a significant telecommunications network for more than 16 years. In 1994, Gainesville Regional Utilities partnered with Shands at UF to provide network facilities. Around that time, changes in the Federal Communication Commission assignments of radio spectrum required GRU to vacate radio spectrum, which triggered a need at GRU to expand its use of fiber optics. That was the “perfect storm” that led GRU to construct its fiber optic network with which GRUCom began to provide data services. The utility added high-speed broadband access in 2000. GRUCom serves as a host for interconnecting private networks and its transport services are used to connect the public safety radio networks.

GRUCom provides Metro Ethernet and SONET-based services, including high-speed Internet access (bulk and retail), data transport, data center co-location, public safety data and radio communications, and carrier-class, point-to-point data circuits. GRUCom also has radio towers in place that it used for electric substation radio service supply that became available for other use after the FCC required GRUCom to vacate its frequencies. These towers are now used to provide services to all wireless carriers. A full description provided by GRUCom in response to

the 2009 Local Broadband Inventory Survey conducted by DMS can be found in Vol. II SD Appendix I.

8.2.2 Palm Beach County

We describe here Palm Beach County’s collaborative efforts as an example of an innovative approach to provisioning broadband services to its residents. Information technology services in Palm Beach County were ranked third in the United States among large counties in 2010 by the National Association of Counties in conjunction with the Center for Digital Government.¹⁵⁴

Palm Beach County is one of six counties in South Florida that have collaborated to provide broadband services for a number of years. The other counties are: Broward, Indian River, Martin, and St. Lucie, in FDOT District 4; and Miami-Dade County in FDOT District 6.¹⁵⁵

8.2.3 Applications

Palm Beach County provides several applications that are shared among its cities, such as the consolidated emergency dispatch function that has been established through the municipalities of Palm Beach Gardens, Jupiter, and Juno Beach.

When surplus capacity exists, or where the applications are more database- or software-oriented and do not require much in the way of transmission, services can be provided to other public sector organizations with no additional hardware purchases, and no large up-front capital outlay. However, a high speed broadband connection is required.¹⁵⁶ These applications include: water utility-related and human resources-related functions, fixed assets inventory management, business tax receipts, risk information management system, training and employee development, consumer affairs tracking system, and justice services information system.¹⁵⁷ Other potential candidates for shared services include emergency management software and subscription resources maintained by libraries. In addition to local, state, and federal government agencies, Palm Beach County’s shared networking arrangements benefit educational institutions (school districts; Florida Atlantic University; Palm Beach State College); health care providers (Palm Beach County Health Care District; Lakes Regional Hospital); nonprofit organizations, and Scripps Institute.

8.2.4 Cost-sharing Arrangements

Central to Palm Beach County’s success in extending broadband services to a larger user base is its cost-sharing arrangements. These arrangements enable enterprises to invest in network assets

¹⁵⁴ Palm Beach County, “County’s Information Technology Services Rank Third.”

¹⁵⁵ Interview meeting of David Brevitz, Herb Cash and Mark Jamison with representatives of Martin, St. Lucie, Indian River, Palm Beach and Broward county representatives, December 6, 2010.

¹⁵⁶ “Application Services,” Palm Beach County Information Systems Services (undated handout).

¹⁵⁷ Ibid.

and share their surplus capacities rather than engage in financial transactions to obtain capacity. Palm Beach County secured four agreements with other government entities in 2007-2009 for use of cost-shared services. In 2010, it secured 32 new cost sharing/interconnection agreements with municipalities, educational institutions, colleges, non-profits, taxing authorities and counties. Similarly, 29 more cost-sharing agreements were in the design or build-out stages. These cost-sharing agreements are in the form of formal interlocal agreements for network services, server hosting and disaster recovery.¹⁵⁸ Palm Beach County is “using what it has” in collaboration with other public sector entities on a cost-shared basis. Palm Beach County managers indicate that the network’s interconnection with FLR was essential to the expansion of its cost-sharing initiative.¹⁵⁹

Palm Beach County determines costs allocated to voice and data network services via its Information Systems Services Cost Allocation Plan (CAP). Operating costs are also subject to cost-sharing. The Plan identifies all costs including staff, vendor contracts, equipment, and all administrative costs including a pro rata share of overhead. Costs to internal departments and agencies are based upon the CAP, and are charged back on a monthly basis. Costs to external agencies are based upon an agreed-upon rate, beginning from a standard rate of \$700 per month per point of connection. There is some variation from this cost allocation plan in the case of school districts due to E-rate considerations.¹⁶⁰

A recent project, The South Florida Shared Fiber Initiative (SFSFI), planned by five counties in the South Florida Collaborative and the Fort Pierce Utilities Authority, was designed to meet the need for broadband-based applications in their respective communities. SFSFI applied for funding through the federal Broadband Technology Opportunities Program (BTOP). The project was not funded through BTOP.

The entities involved in the SFSFI are all located in FDOT District 4. In mid-2010, SFSFI requested the ability to utilize fiber optic cable facilities controlled by FDOT. As described in a Position Paper by SFSFI, the purpose of the initiative is to collaborate to enable use of FDOT fiber networks, for both traffic control and other governmental purposes.¹⁶¹ According to the Initiative participants, local units of government in Florida are prohibited by federal regulation from using the FDOT ITS facilities for any purpose other than traffic control. However, federal regulations also arguably permit waivers, as noted above in the description of FDOT ITS networking. Participants in the SFSFI requested that FDOT seek a waiver of the federal

¹⁵⁸ Palm Beach County Information Systems Services: Roster of Outside Network, Server Hosting and Disaster Recovery Agreements”; December 6, 2010.

¹⁵⁹ Interview meeting of David Brevitz, Herb Cash and Mark Jamison with representatives of Martin, St. Lucie, Indian River, Palm Beach and Broward county representatives, December 6, 2010.

¹⁶⁰ Ibid.

¹⁶¹ South Florida Shared Fiber Initiative, “Position Paper.”

regulation. Additional information about the initiative can be found in Vol. II SD Sec. 15.4.

8.3 Opportunities for Collaboration with Local Authorities

Cities and counties operate communications networks today, serving government, non-profit, educational and economic development locations. These networks include both city/county communications networks and county ITS networks.¹⁶² These communications networks pass close by state government offices, and from a technical perspective, it could be relatively straightforward to use local communications networks to connect state government offices to the MFN network. At a high level, the geographic proximity of the MFN locations to existing local government broadband networking is suggestive of opportunities to collaborate and reduce/share costs for both state and local government. As our financial modeling illustrates, such collaborations can result in budget savings if the local networks have unused capacity such that network facilities can be obtained at less than market rates. Collaboration on provision of a different service, FIRN2, might similarly benefit from proximity of underutilized facilities. Local school districts currently aggregate many schools to one FIRN2 connection provided by DMS. According to DMS, FIRN2 will migrate to MFN at the expiration of the FIRN2 contract.

The potential of using local networks to interconnect state government locations to the MFN can be illustrated using GIS data for local networks, state government locations, and locations served by local networks, shown using the Palm Beach County network information, both county ITS and county communications networks, with MFN locations overlaid, shown in Figure 8-1. In this figure, MFN locations are indicated by green triangles. This example is illustrative of the general concept, and such opportunities to collaborate and reduce/share costs are possible wherever MFN locations exist near local government broadband networking. The extent to which collaboration could yield cost savings would need to be explored with additional information for each location including identification of potential broadband network access points for interconnection, determination of whether underutilized capacity exists to enable and support the interconnection, as well as relevant costs of engineering and establishing the interconnection. However, risks and costs associated with reducing current utilization of local access under MFN and FIRN2 services would need to be considered as well, since the contract providers base their pricing on aggregate participation and revenue from the contracts.

¹⁶² Some counties currently are working to foster collaborative approaches between the county communications networks and county ITS networks.

Figure 8-1. Overlay of MFN Locations on Palm Beach County Fiber Optic Networking

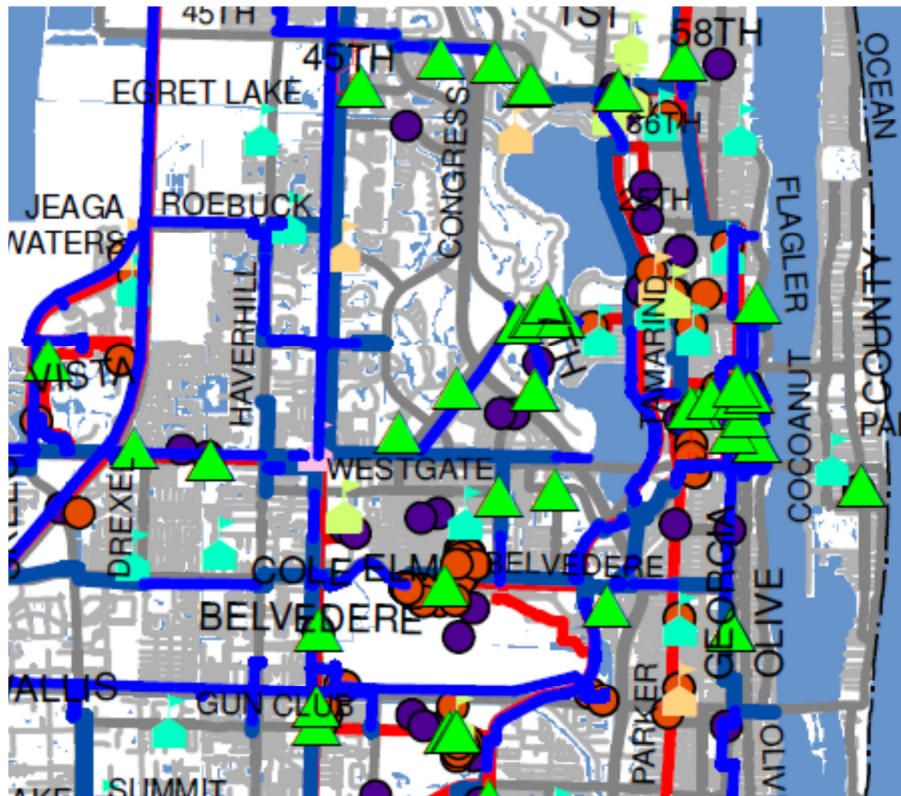

LEGEND

- ▲ MFN LOCATIONS
- ITS UNDERGROUND FIBER
- PBC SCHOOLS**
- TYPE**
- ▲ ADULT COMMUNITY
- ▲ ALTERNATIVE
- ▲ ESE
- ▲ ELEMENTARY
- ▲ HIGH
- ▲ MIDDLE
- PBC-ISS FIBER SITES
- PBC-ISS WAN SITES
- ITS AERIAL FIBER
- PBC ISS FO UNDER CONSTRUCTION
- PBC ISS FIBER
- PBC COUNTY BNDRY

Source: Palm Beach County Information Systems Services.

The state should consider the opportunities it may have to collaborate with local governmental units to better utilize underutilized or otherwise available facilities for governmental cost-

savings. Examples might include use of FDOT ITS facilities in particular locations, and DMS’s use of the TIPS service¹⁶³ to use underutilized local government facilities to extend access to MFN locations.

8.4 ARRA Broadband Technology Opportunities Program (BTOP)

Funding opportunities, such as federal BTOP grants, are being used in Florida to propel middle-mile infrastructure deployment and furthers connectivity among governmental entities at all levels. Expanding networks could create new possibilities if they are economically viable. However, states need to be positioned to take advantage of the opportunities, and failure to do so could affect the viability of the new networks. Descriptions of the BTOP infrastructure projects funded in Illinois, New York, Ohio, and Pennsylvania are included in Vol. II SD Sec. 16. In contrast to Illinois and Ohio, New York, Pennsylvania, and Florida did not have statewide strategic plans in place prior to the availability of the federal funding. It is not clear whether it is only coincidence that there was less BTOP infrastructure funding awarded in those latter three states compared to states with strategic plans in place prior to the grant awards.

Florida entities received a total of \$55.9 million of BTOP funds for three infrastructure projects that will be implemented completely within the state:

- The North Florida Broadband Authority received \$30.1 million for a middle-mile project to provide high-speed broadband services to underserved areas in 14 North Central Florida counties. The project will involve deployment of a 1,200 mile fixed wireless broadband network. The project was jointly created by the area’s local governments and is planned to serve more than 300 community anchor institutions.
- The FRBA received \$23.7 million to deploy 1,800 miles of microwave-based middle-mile network infrastructure in three designated RACECs. A goal of the project is to create a collaborative effort of local and tribal governments, economic development agencies and commercial partners to address the broadband needs of the area.
- Level 3 EON, LLC, was awarded \$2.1 million to build seven new access points on Level 3’s existing broadband network to enable access for last-mile providers.

DMS took an active part in supporting the development of the NFBA and FRBA projects.

8.5 Barriers to Local Use of Broadband

In the previous section, we cited two examples of innovative local approaches to the provisioning of broadband services. Below we describe barriers local governments encounter in fully exploiting their potential for offering those services themselves. As Table 8-1 shows, analysis prepared by Magellan Advisors categorized those barriers into three groups: policy and

¹⁶³ TIPS is discussed in more detail in the “Competitive Access” section of the recommendations, above.

regulatory, organization, and technical:

Table 8-1. Magellan Advisors Barriers to Local Government Broadband Development

ISSUES	BARRIERS
Policy and Regulatory Issues	<ul style="list-style-type: none"> ▪ FDOT state policy legislation on use of ITS fiber communications infrastructure ▪ FDLE state policy legislation on the use of public safety fiber communications infrastructure ▪ Federal Highway Administration policy legislation on use of ITS fiber communications infrastructure ▪ Utility regulation concerning the security of control and telemetry data on fiber infrastructure ▪ Lack of clarity on state legislation concerning municipal telecommunications utilities (Florida House Bill 1322 applicability to dark/lit fiber and transport services)
Organizational Issues	<ul style="list-style-type: none"> ▪ Joint ownership issues between local organizations owning fiber infrastructure ▪ Ownership issues within the organization itself (i.e. between a electric utility entity and the respective local municipality, who owns the assets and who has control) ▪ Lack of resources and/or capabilities to manage a commercial fiber-based network
Technical Issues	<ul style="list-style-type: none"> ▪ Inadequacy of existing fiber infrastructure to provide commercial services ▪ Lack of mapping information on location of fiber infrastructure assets ▪ Lack of technical standards in network construction and operations

Source: Magellan Advisors, LLC, Local Government Communications Use and Municipal Broadband Development.

According to the Magellan report, of the three categories listed above, policy and regulatory barriers constitute the largest impediment for local government provisioning of broadband for commercial services.¹⁶⁴ Among the policy and regulatory barriers, the policies and practices of FDOT, with respect to federally funded ITS infrastructure, resonated as a barrier with a number of cities and counties we interviewed. As described Vol. II SD Sec. 14.5.3, use of ITS communications networking is restricted to “highway purposes” by federal statute, under which funds are provided to the state to construct the ITS. For example, as noted by Palm Beach County:

The largest gap is the legislated regulations that require the traffic fiber installed as part of the Intelligent Traffic Network (ITS) to be dedicated solely for

¹⁶⁴ Magellan Advisors, LLC, *Local Government Communications Use*.

transportation and traffic-related purposes. Meanwhile, the substantial quantities of unused bandwidth lie wasting while taxpayers of Palm Beach County pay a commercial carrier **approximately \$1 million annually** for leased lines that serve County facilities which are in close proximity to the traffic fiber. It chagrins us to know this in the light of the federal government’s recent BTOP grant programs, as well as the budget challenges facing Palm Beach County and all other public sector organizations. The economic realities have been the motivating factor behind our longstanding effort to address this issue, including participation in the South Florida Shared Fiber Initiative.¹⁶⁵ (emphasis in original)

The city, county, and DMS viewpoint expressed above is based on the belief that there is “unused bandwidth” in the ITS facilities deployed by FDOT. However, FDOT deploys facilities based on a 10-year plan with a long-range planning horizon. Network planners routinely reserve capacity for future use. We were told by FDOT officials that the number of fiber strands deployed by FDOT for ITS ranges from 24 to 96, with 72 and 96 count fiber as the most common sizes, depending on the segment.¹⁶⁶ We were not able to obtain information regarding how many of the deployed strands are actually in use at the present time. Fiber optic cable utilization information resides at the FDOT district level and is not available at FDOT ITS Program Office. Similarly, information is not available at FDOT ITS Program Office regarding availability of conduit structure that is placed to contain and protect fiber optic strands and equipment. Conduit structure is placed for each segment, and it is possible (or even likely) that not all conduit runs are currently occupied with fiber optic cable. This utilization information can be provided through the districts, but it would require commitment of resources at the district level.¹⁶⁷ Accordingly, we cannot state with any level of certainty the extent to which underutilized facilities actually exist. We also note that the apparent cost savings in using a private carrier may result from differences in how public entities and private operators recognize costs. We model this in Scenario 2 of our financial model described in Section 11 of this Volume and in Vol. II SD Sec. 13.

¹⁶⁵ Palm Beach County, “SFFI and UF Public Utility Research Center Joint Meeting.” Written responses to PURC questions provided at an interview conducted by David Brevitz, Herb Cash and Mark Jamison of representatives of Martin, St. Lucie, Indian River, Palm Beach and Broward county representatives, December 6, 2010.

¹⁶⁶ Email from Randy Pierce, Telecommunications Program Manager, Florida Department of Transportation to David Brevitz, Public Utility Research Center, University of Florida, January 13, 2011.

¹⁶⁷ Similarly, PURC was not able to obtain information regarding availability of conduit structure which is placed to contain and protect fiber optic strands and equipment. Some level of conduit structure is placed for each segment, and it is possible (or even likely) that not all conduit runs are currently occupied with fiber optic cable.

9 Governance and Planning

State government procurement decisions are often integrated into overarching state strategic planning efforts. In some states, those strategic plans helped guide the development of proposals for stimulus funding to expand broadband services. For this project, DMS requested “a comparison of other broadband systems for states of similar size as Florida” to provide a base of relevant information to understand if and how other states are addressing the subject of broadband planning for government use and how broadband networking has developed in those states given potentially different governance approaches. PURC undertook analysis to understand government broadband networks in Florida and to compare those networks to similar networks in four other states.¹⁶⁸ PURC and DMS staff identified four states for this comparison: Illinois, New York, Ohio, and Pennsylvania.¹⁶⁹ Detail of the comparison is found in Vol. II SD Sec. 16.

Our analysis of the states provided valuable insights, particularly as they applied to better understanding Florida’s governance policies and opportunities. In Vol. II SD Sec. 16, we describe the planning and governance structures that have facilitated progress toward strategic plan implementation in New York, Ohio, Illinois, and Pennsylvania.

In contrast to those and other states, Florida apparently has never engaged in a comprehensive broadband strategic planning effort that considers all state and local government broadband. In other states examined for this report, as in Florida, not all broadband needs of all anchor institutions are being met by a single network. The courts and legislature constitute different branches of government that are generally not required to participate in the Executive Branch networks, although they do in many instances.

9.1 State Enterprise IT Governance

Providing IT services to state agencies, with their varied needs and business processes, is facilitated by a governance structure that is capable of organizing resources in the most effective manner. There are a number of working definitions of “governance” in the IT industry.¹⁷⁰ Most share elements of planning, collaborative and transparent decision making, and accountability.

In a 2008 publication, the National Association of State Chief Information Officers (NASCIO),

¹⁶⁸ Each of the four other states’ networks was compared in this analysis to relevant networks in Florida. The four other states were not compared to each other.

¹⁶⁹ New York is the largest, with a population of 19,541,453 persons. Florida is next largest with a population of 18,537,969. Illinois, Pennsylvania, and Ohio have populations of 12,910,409, 12,604,767, and 11,542,645, respectively. Population numbers are for July 1, 2009. Source: Table 1. Annual Estimates of the Resident Population for the United States, Regions, States, and Puerto Rico: April 1, 2000 to July 1, 2009 (NST-EST2009-01), U.S. Census Bureau, Population Division. Release Date: December 2009.

¹⁷⁰ See, for example, IT Governance Institute, *IT Governance Roundtable*.

focused on IT governance in state government by describing it as being “all about ensuring that state government is effectively using information technology in all lines of business and leveraging capabilities across state government appropriately to not only avoid unnecessary or redundant investments, but to enhance appropriate cross boundary interoperability.”¹⁷¹ In the context of interoperability, enabling the sharing of information and other resources, governance also has been defined by the Center for Technology in Government as “the existence of appropriate decision making rules and procedures to direct and oversee government interoperability initiatives that are planned or underway . . .”¹⁷²

Management and decision-making models in IT are sometimes arrayed along a spectrum of less centralized to more centralized. For example, a 2009 publication by the Center for Technology in Government characterized the governance authority of New York, Pennsylvania, and Florida, as “hybrid/federated.” The report describes three types of governance structures: centralized, hybrid/federated, and decentralized:

In a centralized governance structure, sole authority and decision making power are vested in the central IT organization, resulting in greater control over IT resources at the price of decreased flexibility. In contrast, a decentralized governance structure gives all IT decision-making power to agency IT departments, which gives individual departments flexibility needed to react to their environment, but also results in a complete lack of coordination across the state. In a federated/hybrid structure, the authority over IT decision-making is distributed between the central IT organization and the agency IT departments. This arrangement offers both the flexibility needed for individual agencies, while also retaining some degree of centralized control over IT.¹⁷³

Table 9-1 summarizes these governance arrangements and identifies example states.

Information technology governance has been high on the agenda of NASCIO for a number of years, but the focus on the best ways in which to integrate and manage IT across large enterprises is not unique to state governments.¹⁷⁴ The IT Governance Institute (ITGI) was established in 1998 “to advance international thinking and standards in directing and controlling an enterprise’s information technology.”¹⁷⁵ The importance of IT governance to both public and private sector

¹⁷¹ National Association of State Chief Information Officers, *IT Governance and Business Outcomes*.

¹⁷² Pardo and Burke, *IT Governance Capability*, 1.

¹⁷³ Hrdinová et al., *Enterprise IT Governance*, 1-2.

¹⁷⁴ De Haes and Van Grembergen, “Moving from IT Governance.”

¹⁷⁵ IT Governance Institute, “About ITGI,”

http://www.itgi.org/template_ITGIId585.html?Section=News_Releases&Template=/TaggedPage/TaggedPageDisplay.cfm&TPLID=46&ContentID=14298, accessed September 25, 2010. ITGI was established by ISACA (ISACA is an independent, nonprofit, global association that engages in the development, adoption and use of globally

entities is apparent in the research and publications of both NASCIO and ISACA.¹⁷⁶

Table 9-1. Common Arrangements of Governance Authority Patterns

Centralized	Hybrid/Federated	Decentralized
State CIO, including central state IT organization, has authority over all areas of IT, including IT management, services, general management, and operational functions.	Authority for IT areas, including IT management, services, general management, and operational functions are distributed among both the state CIO, including central state IT organization, and individual state agency CIOs.	State agency CIOs have authority over all IT areas, including IT management, services, general management, and operational functions.
Maine, Michigan	California, Florida, Georgia, Kansas, Kentucky, Minnesota, New York, North Carolina, Pennsylvania, Texas, Virginia	

Source: Hrdinová et al., *Enterprise IT Governance*, 2.

In the five states we examined, we found commonalities in the various IT governance structures. Those include officially articulated expectations in statutes and other documents that planning and implementation will be highly collaborative. The IT governance structures of these states have an officially designated center of the governance and planning function, many with a CIO or position of equivalent status with broad authority over all aspects of IT in the Executive Branch. The existence of a central point for IT governance activities may or may not result in a centralized approach to technology acquisition and deployment. Across these states there is a movement to consolidate state government IT functions in order to achieve greater efficiency and benefit from public investment in the systems.

9.2 Florida IT Governance

In Florida, in contrast to other states reviewed, the planning responsibilities of enterprise IT are not centralized in one planning agency. Indeed, three entities, AEIT, TRW, and DMS share that responsibility. In addition, Florida’s state agencies are responsible for planning that is applicable to agency-specific IT projects and activities. Below we summarize these three agencies’ roles in

accepted, industry-leading knowledge and practices for information systems. ISACA was incorporated as the EDP Auditors Association in 1969 by a group that recognized the need for a central source of information and guidance in the field of auditing controls for computer systems. ISACA defines the roles of information systems governance, security, audit and assurance professionals worldwide.)

¹⁷⁶ See publications at NASCIO: <http://www.nascio.org/publications/> and ISACA <http://www.isaca.org/Knowledge-Center/Pages/default.aspx>

governance structures. A more detailed description can be found in Volume II, Sec 8.

9.2.1 Agency for Enterprise Technology (AEIT)

AEIT established in Florida law¹⁷⁷ in 2007, responds to the highest level of the enterprise, the Governor, the constitutionally created Cabinet, and the legislative leaders. The Governor and the Cabinet are designated as head of the Agency. The Executive Director of AEIT is appointed by the Governor and confirmed by the Cabinet, subject to confirmation by the Senate, and serves at the pleasure of the Governor and Cabinet. The statutory scheme provides a level of accountability by requiring AEIT to report to the Governor and Cabinet, President of the Senate, and Speaker of the House of Representatives about the progress toward completion of the prior year’s plan within the first 60 days of each fiscal year.¹⁷⁸

AEIT is charged with developing policies for “the most effective and efficient use of the state’s information technology”¹⁷⁹ for agencies of the Executive Branch.¹⁸⁰ AEIT’s duties and authority can be separated into three functions: 1) identifying and developing plans for potential enterprise IT services; 2) executing specified duties for statutorily designated enterprise IT services; and 3) participating in development and implementation of consolidated procurement of IT goods and services. Unlike CIOs in some states, the Florida CIO does not have formal authority to approve agency budgets or projects. Rather, IT budget and project review and monitoring are the responsibility of the TRW.¹⁸¹

The description by the Center for Technology in Government of IT system authority in Florida as “hybrid/federated” is a conclusion consistent with the statutory language. A separation of responsibilities is created by law whereby state agencies are responsible for “the supervision, design, delivery, and management of agency information technology”¹⁸² The statute creates

¹⁷⁷ Sections 282.003-282.34, Florida Statutes. Questions about interpretation or applicability of these or other provisions of Florida law should be directed to competent legal counsel. Statutes cited were accessed from <http://www.leg.state.fl.us/statutes/>. Session laws cited were accessed from <http://laws.flrules.org/>.

¹⁷⁸ Section 282.0056(5), Florida Statutes.

¹⁷⁹ Sections 14.204(4) and 282.0055, Florida Statutes. See also Agency for Enterprise Information Technology, 2010 *Enterprise Information Technology Services Strategic Plan*.

¹⁸⁰ “Agency” is defined to mean “any official, officer, commission, board, authority, council, committee, or department of the executive branch of state government” Section 216.011(1)(qq), Florida Statutes. The definition does not encompass the Legislative and Judicial Branches. For purposes of Chapter 282, the definition also excludes university boards of trustees and state universities. Section 282.0041(1), Florida Statutes.

¹⁸¹ Created in 1997, the Workgroup’s authority is codified at section 216.0446, Florida Statutes. TRW analyzes and provides to the Legislative Budget Commission recommendations regarding agency funding requests for information technology projects. TRW also conducts oversight of information technology projects identified in the General Appropriations Act. <http://trw.state.fl.us/>, accessed August 20, 2010.

¹⁸² Section 282.0055, Florida Statutes.

a distinction between agency and enterprise IT by defining “agency information technology service” as “a service that directly helps an agency fulfill its statutory or constitutional responsibilities and policy objectives and is usually associated with the agency’s primary or core business functions.”¹⁸³ “Enterprise information technology service” is a subset of state IT functions that are used in all or most agencies “. . . and is established in law to be designed, delivered, and managed at the enterprise level.”¹⁸⁴ The requirement for designation of enterprise services in law ensures that the Governor and Legislature are involved in defining the scope of AEIT’s responsibilities. Services currently designated in statute as being enterprise IT services include state data centers, statewide e-mail, and enterprise IT security.¹⁸⁵

Certain services lend themselves to centralized procurement and implementation, that is, to being “enterprise” services. AEIT by law provides input to the designation of enterprise services. The Agency is responsible for making “recommendations to the [Governor and Cabinet] and the Legislature concerning other information technology services that should be designated, delivered, and managed as enterprise information technology services. . . .”¹⁸⁶ Under its authority, AEIT is able to recommend that broadband or data communications networking be designated, delivered and managed as an enterprise IT service, but has not done so up to this point.

AEIT is required to develop both a long term plan and an annual work plan within the first 60 days of each fiscal year.¹⁸⁷ The annual plan must be presented at a public hearing that includes the Agency CIO Council. The council is specifically authorized to review and comment on the plan. Approval of the annual work plan, or any amendment to it, is reserved to the Governor and the Cabinet. The President of the Senate and Speaker of the House must receive copies of the annual plan.¹⁸⁸ State agencies are required to provide to AEIT information necessary to complete its annual plan.¹⁸⁹ A number of other planning activities are described in the act.

AEIT’s first long-term strategic plan was published October 1, 2010, as required by law. The agency must biennially update the plan that addresses improvements in the delivery of enterprise IT services.¹⁹⁰ AEIT recommended in its *2010 Enterprise Information Technology Service Strategic Plan* that two new enterprise services be designated by July 1, 2011, IT Disaster Recovery and GIS, and that two services be studied for potential designation as enterprise

¹⁸³ Section 282.0041(5), Florida Statutes.

¹⁸⁴ Section 282.0041(13), Florida Statutes.

¹⁸⁵ Sections 282.201, 282.318(2), and 282.34, Florida Statutes. See also Agency for Enterprise Information Technology, *2010 Enterprise Information Technology Services Strategic Plan*.

¹⁸⁶ Section 14.204(4)(c), Florida Statutes.

¹⁸⁷ Section 282.0056(1), Florida Statutes.

¹⁸⁸ *Ibid.*

¹⁸⁹ Section 282.0056(4), Florida Statutes.

¹⁹⁰ Section 14.204(4)(e), Florida Statutes.

services, local area network services and end-user seat management.¹⁹¹ Disaster Recovery: “The centralization of IT infrastructure (hardware and software) into three primary data centers in one city, combined with the lack of a comprehensive IT disaster recovery (DR) solution spanning multiple agencies, has increased the risk associated with any disaster. Therefore, Florida needs a standardized IT DR solution for the state. ... AEIT recommends creation of a standardized enterprise IT DR solution.”¹⁹²

The CIO Council uses the AEIT Advisory Committee to “advise and assist the AEIT in the planning, coordination and communication of Enterprise Information Technology Services.”¹⁹³ According to the AEIT Advisory Committee Charter, its purpose is to “facilitate the interaction between the CIO Council and the Agency for Enterprise Information Technology, in developing strategies for implementing enterprise information technology services established by law and developing recommendations for enterprise information technology policy.”

9.2.2 Technology Review Workgroup

A key component of information technology governance is alignment of expenditures for projects, infrastructure and related components with enterprise goals and objectives. In Florida, responsibility for budget oversight within the IT governance structure is assigned to TRW, a Legislative Branch entity. Florida’s IT governance structure does not include an Executive Branch entity that has a similar responsibility regarding state IT budgeting.

TRW was created in 1997 to provide analysis, findings and recommendations to the Legislative Budget Commission regarding agency funding requests for IT projects. TRW supports the work of the House and Senate Appropriations committees in analysis of funding requests for IT. TRW also participates with the House and Senate Appropriations analysts, and staff from the Governor’s Office of Policy and Budget, in overseeing high-cost, high-risk, or highly complex IT projects specifically identified in the General Appropriations Act.¹⁹⁴

In addition to those ongoing responsibilities, the Legislature has assigned specific projects to TRW in statute. For example, Chapter 2009-61 of the Laws of Florida required TRW to develop a proposed plan for identifying and recommending options for implementing the provisions of state law, requiring creation of an integrated computer system for the state courts.

¹⁹¹ Agency for Enterprise Information Technology, *2010 Enterprise Information Technology Services Strategic Plan*.

¹⁹² *Ibid.*, 4.

¹⁹³ http://www.myflorida.com/cio/committees_groups/AEIT.shtml.

¹⁹⁴ Section 216.0446, Florida Statutes and information about TRW responsibilities found at <http://trw.state.fl.us/>, accessed September 10, 2010.

9.2.3 Department of Management Services (DMS)

Operational planning for the Florida’s enterprise telecommunication network infrastructure (SUNCOM) is conducted by DMS, as prescribed by law. In addition, specific planning-related responsibilities, beyond those required for operation of the SUNCOM network, were assigned to DMS in 2009. Pursuant to Section 364.0135 of the Florida Statutes, DMS is charged with promoting broadband deployment in the state. As part of that effort, the DMS is charged with the creation of a strategic plan for increasing the use of broadband Internet service in the state. The statute authorizes DMS to initiate certain actions in order to fulfill its responsibilities. DMS may collaborate with, and receive staffing support and other resources from, Enterprise Florida, Inc., state agencies, local governments, private businesses, and community organizations to:

- Conduct a needs assessment of broadband service in order to develop maps that will: show areas that are not served by any broadband provider, and areas served by only one provider; show the transmission speeds available; and provide a baseline assessment of the portion of households with broadband availability;
- Create local broadband planning groups composed of representatives from a cross-section of the respective community and facilitate the efforts of those planning groups; and
- Encourage the use of broadband service through grant programs facilitating deployment of broadband, especially in rural, unserved, and underserved communities. Priorities for any such grants are described in the statute.

DMS may apply for and accept federal funds, gifts and donations for the purposes described in the statute. In addition, DMS may adopt rules and regulations, establish committees or workgroups, and enter into contracts necessary or useful, to implement the statute.

10 E-Rate Funding

The largest source of federal funding for K-12 school and library procurement of advanced telecommunications and Internet access services and equipment is the federal Universal Service Fund Schools and Libraries Program, commonly known as the “E-rate” program. In the last few years, the FCC, which oversees the program, has focused on policy aimed at encouraging the deployment and use of broadband networks and services, as reflected in its National Broadband Plan issued March 16, 2010,¹⁹⁵ and the September 2010 *Sixth Report and Order* that makes the most substantial changes to the E-rate program since its inception. The substantial changes from the *Order* include:

- making leased dark fiber eligible for E-rate support and permitting non-telecommunications providers of fiber and fiber-based services eligible to provide telecommunications services to eligible schools and libraries.
- indexing of the E-rate cap of \$2.25 billion a year for inflation.
- permitting community members to use E-rate funded school facilities and services outside of school hours, making certain residential school facilities eligible for funding, and streamlining the E-rate application process.¹⁹⁶

These changes regarding fiber optic facility eligibility make it possible for government, nonprofit, and privately owned fiber network providers to compete with traditional telecommunications companies for broadband infrastructure and connectivity contracts with eligible schools and libraries. However, the impact of the new rules will not be clear until they are actually interpreted and applied in practice. The fiber, which is newly eligible for use in provisioning supported E-rate services in specific cases, is subject to numerous conditions, categorizations and distinctions. On December 15, 2010, the FCC, through its Wireline Competition Bureau, provided guidance in a Public Notice¹⁹⁷ to address a number of detailed questions about the new E-rate rules as they pertain to “dark fiber.” The rules and their application are very complex regarding the use of newly eligible fiber optic facilities, and therefore broad statements on impact of this change cannot yet be made. It is clear however that specialized expertise will be required to properly obtain the benefits from this new avenue of support for fiber optic facilities for E-rate services.

The annual E-rate application process requires a number of steps to be completed and forms to

¹⁹⁵ Federal Communications Commission, *National Broadband Plan, Connecting America*, (rel. Mar. 16, 2010, National Broadband Plan).

¹⁹⁶ Federal Communications Commission, *Schools and Libraries Universal Service Support*. (See this order for detailed information summarized in this paragraph about the changes to E-rate policy.)

¹⁹⁷ Wireline Competition Bureau Provides Guidance Following Schools and Libraries Universal Service Support Program Sixth Report and Order; CC Docket No. 02-6, GN Docket No. 09-51; released: December 15, 2010.

be filed by both applicants and service providers, but the majority of requirements are placed on school and library applicants. In general, applicants seeking new discounts must initiate a competitive bidding process by filing a Form 470 (Description of Services Requested and Certification Form) with the Universal Service Administrative Company (USAC), which is posted on USAC's website for at least 28 days, during which the applicant must evaluate all submitted bids. For each funding request, the applicant may choose a service provider and sign a contract after the USAC-assigned "Allowable Contract Date." Then the applicant must file a Form 471 (Services Ordered and Certification Form) with USAC to apply for funding for eligible discount amounts.

State entities are permitted to competitively bid and negotiate state master contracts for use by eligible schools and libraries. This can be accomplished in two ways:

1. The state files the Form 470. If the state files a Form 470, then the applicant may cite the state's Form 470 on its Form 471. The state must follow a competitive bidding process pursuant to FCC requirements and state procurement law. The applicant is required to follow the applicable provisions of the state master contract, and state and local procurement laws. No separate bidding documents or contracts are required by the applicant citing the state's Form 470, other than what is required by the state master contract, and state and local procurement laws. The signed state master contract between the state and the service provider meets the FCC signed contract requirement.
2. The applicant files the Form 470 and considers a state master contract as one of the bids it receives. The applicant must follow a competitive bidding process pursuant to FCC requirements, and state and local procurement law. Price must be the primary factor - that is, it must be weighted more heavily than any other factor in the applicant's evaluation of bids. If the applicant selects the state master contract as the most cost-effective alternative, the applicant is required to follow the applicable provisions of the state master contract, state contract law, and state and local procurement laws. The signed state master contract between the state and the service provider meets the FCC signed contract requirement.

The FIRN2 contract between DMS and AT&T and its subcontractors is a state master contract. FIRN2 is described in Vol. II SD Sec. 18. The procedure in Florida for filing forms with USAC is as follows. The Florida DMS files a Form 470 and negotiates and enters into a contract with its chosen service provider (currently AT&T). In the past, DOE administered the E-rate program on behalf of public schools and the non-discounted portion was subsidized by funds received by the DOE from a state fund created for that purpose. Under that arrangement, the DOE submitted Forms 471 on behalf of schools and libraries. The schools/libraries had the option of removing service from the FIRN contract or they could file their own Form 470 and choose either the

FIRN2 contract or another provider (in which case they would file a Form 471 for that provider). For example, in Funding Year (FY) 2009, the DOE filed seven Forms 471: each covered a different group of eligible entities (e.g., school districts, the Panhandle Area Education Consortium, the Northeast Florida Education Consortium). However, several individual school and library applicants elected to file Forms 471 on which they indicated that they chose AT&T as their service provider under the FIRN2 contract (e.g., Alachua County School District, Brevard County Library System, Brevard County School District, The Florida School for the Deaf and Blind, The Florida Virtual School). Some schools and libraries appear to have received funding under both the DOE Form 471 and their own Forms 471 (likely for different services under the same contract).

Beginning with E-rate FY 2010, the DOE ceased to file the Forms 471 on behalf of schools and libraries and they are now responsible for submitting the Forms 471 on their own. Further, because of the state budget crisis, schools must now finance their non-discounted portions through the Florida Education Finance Program or other school district resources. The previous consolidated approach used dedicated state employee positions to handle the processing of applications. According to one source, the consolidated E-rate process cost the citizens of Florida less money overall even though it may have cost the State of Florida more.¹⁹⁸ It is not yet clear whether the consolidated application process yielded a larger amount of federal E-rate funds for Florida applicants compared to the current approach. Because we are in the middle of the first funding year for which each recipient is responsible for applying on its own, there is not yet a complete year of funding information available to compare to the old approach.¹⁹⁹

Other states differ in how they administer E-rate funding for eligible schools and libraries. For example, the Ohio K-12 Network, a joint effort between eTech Ohio and the Ohio Department of Education, subsidizes services for Ohio's public school districts that connect classrooms to each other and the Internet. To be eligible for the state subsidy, Ohio school districts must maintain a connection to the Ohio Education Computer Network, meet certain technical conditions regarding connectivity, and apply for E-rate support. For FY 2011, the state subsidy is \$2,000 per building per year.²⁰⁰

In New York, the E-Rate Resource Center in the New York State Education Department handles

¹⁹⁸ Interview by David Brevitz, Public Utility Research Center, University of Florida, with Ron Lauver, Special Assistant to the CIO, Florida Department of Education, November 4, 2010. The reason provided is that each school district did not have to dedicate resources to the application process and related administrative requirements, which can be quite burdensome.

¹⁹⁹ As we explain later, even during the time that the State provided assistance to the districts, Florida received less E-rate money per pupil than its peer states and it does not appear that the difference can be explained by differences in qualifying criteria. So it would appear that even if the state assistance was beneficial, it was inadequate to bring Florida into par with its peer states in terms of E-rate participation.

²⁰⁰ eTech Ohio, "eTech Ohio Eligibility."

the E-rate application process.²⁰¹ Public libraries and library systems submit their E-rate applications directly to USAC.²⁰² In contrast to New York’s more centralized approach, in Pennsylvania federal E-rate is not centrally administered for schools. Like Ohio, Pennsylvania offers a state subsidy (the state E-Fund grant program²⁰³) to augment the federal E-rate discount. To qualify for state E-Fund grants, schools must qualify for and receive federal E-rate support that may be used as a match for the state funds. The Pennsylvania Department of Education provides coordination and other forms of assistance to applicants for E-rate support and is the administrator of the state E-Fund program.²⁰⁴ In Illinois, individual K-12 schools, libraries and other E-rate eligible entities may participate by signing a letter of agency permitting the Illinois Century Network to procure E-rate support on their behalf.²⁰⁵

In addition to the services available to schools and libraries under the FIRN2 contract, DMS makes available the services it offers to state agencies and institutions through other contracts to K-12 schools and libraries.²⁰⁶ For example, in FY 2009, DMS posted a Form 470 for Telecommunications, Bundled and Unbundled Internet Access Services, E-mail VoIP, and Web Hosting on which it listed FIRN as a Billed Entity (entities listed as “billed entities” are those to which the services will be offered for purchase) in addition to listing all eligible schools and libraries in the state. DMS also posted several other Forms 470 for various telephone services, internal connections, and “Internet Broadband Access” wherein it did not list FIRN as a Billed Entity but did list all eligible schools and libraries in the state. USAC FY 2009 funding information indicates that some individual schools and libraries chose DMS contracts for POTS, Digital Transmission Services, and 800 Service. For example:

- Highlands County School District contracted with Embarq for local telephone service provided under a DMS state contract;
- Desoto County Library, Leon County School District, Orange County School District, Okaloosa County School District, Okeechobee County School District, the FSU School, the Panhandle Area Education Consortium, and the School District of Volusia County contracted with Embarq for local telephone services and/or digital transmission services

²⁰¹ New York State, Education Department, “E-Rate Resource Center.”

²⁰² New York State Library, “E-Rate for Libraries.”

²⁰³ 2004 Act 183 codified at Title 66 section 3011, *et seq.* The Pennsylvania E-Fund program provides annual grants to cover certain costs of establishing and supporting broadband networks between, among and within schools and for distance learning projects that utilize broadband networks. The program is scheduled to end in 2011 (the 2010-2011 school year is the last for which funds will be available under the current statutory authorization).

²⁰⁴ Pennsylvania Department of Education, *E-Fund Enabling 21st Century Connectivity for Learning*.

²⁰⁵ Illinois Century Network, *Provisions for Universal Service*.

²⁰⁶ “SUNCOM continues to provide E-rated service to schools and libraries that now seek E-rate grants without DOE assistance. But the assistance must come from billing and engineering staff that are not experts and have competing duties.” Department of Management Services, *Division of Telecommunications Business Model*, 10.

- under a DMS state contract;
- Auburndale Public Library, Bartow Public Library, Dr. C.C. Pierce Municipal Library, Dundee Public Library, Eagle Lake Public Library, Haines City Public Library, Lake Alfred Public Library, Lake Wales Public Library, Latt Maxcy Public Library, Polk County Law Library, Polk County Library, Winter Haven Public Library, the Panhandle Area Education Consortium, Pinellas County Schools, and Polk County School District contracted with Verizon Florida for local telephone service and/or digital transmission services under a DMS state contract;
- The Panhandle Area Education Consortium contracted with Deltacom, Inc. for 800 services under a DMS state contract.

Finally, in addition to the services available through DMS state master contracts, Florida schools and libraries can and do solicit bids and contract for equipment and services from a variety of commercial service providers and, increasingly, local government and nonprofit service providers (e.g., City of Gainesville).

Because of the new E-rate rules permitting non-telecommunications entities to provide telecommunications services over fiber networks, FLR can become a new telecommunications service provider option for schools and libraries. FLR originally was created to provide a data communications network and access to Internet 2 to state universities. Today, FLR utilizes dedicated and shared 10Gbps or 1 Gbps data circuits to provide members access to the Internet, connectivity to other regional and national networks (e.g., Abilene Internet2 backbone, National LambdaRail), high speed transit IP paths between members, network peering between the FLR and other data networks, and Virtual Private Networks (VPNs), among other services. Its customer base has expanded to include local and state government agencies and private sector entities.²⁰⁷ Furthermore, DMS and FLR are in discussions to connect the FLR and MFN networks. This could help address the challenges for school districts to interconnect with FLR on a cost-effective basis, since each FLR member must procure its own local access facility. If MFN and FLR interconnect, the school districts would be able to use the MFN contract prices, or the competitive access provisions of MFN for access. Finally, as FIRN2 connections transition over to MFN following expiration of the FIRN2 contract, school districts will be able to use that connection for access to MFN and FLR resources available on those networks, including Internet2.

In November 2006, FLR became an Internet2 Sponsored Education Group Participant (SEGP), which enables it to provide access to Internet2 to K20 institutions connected to its network. The

²⁰⁷ <http://www.flrnet.org>; Department of Management Services, *Division of Telecommunications Business Model*, 54-55.

SEGP, initially sponsored by FLR members Florida State University, University of Central Florida, Florida Atlantic University, University of Florida, Florida International University, and University of Miami, connected member K-12 schools, libraries, community colleges, performing arts centers and museums. In February 2009, FLR, the University of South Florida (USF), and Internet2 announced an expansion of the SEGP. The University of South Florida, which had been providing Internet2 access to FIRN2, became a member of FLR. As of 2009, the SEGP enables Florida K20 institutions to directly interact with K20 institutions connected to Internet 2 in 36 other states. The SEGP network connects to Internet2 through the University of South Florida's FIRN2 connection as well as through FLR via Southern Crossroads, a federation of research and education institutions that cooperate to provide high-speed, global connectivity to the Southeastern U.S. Research and Education community.²⁰⁸

Table 10-1 provides a summary of E-rate commitments (total application dollars approved by USAC) and disbursements (total dollars actually disbursed by USAC) for 1998-2009 for Florida and the comparison states, New York, Ohio, Pennsylvania, and Illinois. The data in this table show that, as of the publishing date of the 2009 USAC Annual Report, Florida had average performance relative to comparison states in terms of receiving a meaningful portion of the monies committed, but it was far behind in terms of dollars per student.²⁰⁹ In this snapshot, Illinois, which is closest to Florida in terms of dollars per student, receives about 40 percent more per student than does Florida. New York receives nearly 250 percent more per student than Florida. Florida's results probably cannot be explained by differences in qualifications because they are based on income and Florida is next to last among these states in per capita income. On the surface, it appears that Florida did relatively poorly, but it is unclear which factors led to this.

A random sampling of 2009 Florida E-rate recipients who applied for discounts for broadband connectivity reveals a variety of technologies and providers as well as a wide range of bandwidth utilization. For example, several individual schools solicited bids for T1-T3 lines, cable modem and DSL services. The Form 471 asks applicants to indicate, when relevant, the number of buildings served by direct broadband services at speeds (a) less than 10 Mbps, (b) between 10 Mbps and 200 Mbps, and (c) greater than 200 Mbps. Of 13 schools, one indicated that it had one building being served at less than 10 Mbps, eight indicated that they had one building being served at between 10 Mbps and 200 Mbps, one indicated that it had two buildings being served at between 10 Mbps and 200 Mbps, and one indicated that it had four buildings being served at more than 200 Mbps. At the other end of the spectrum, Miami-Dade County Public Schools solicited bids for high bandwidth WAN and high speed Internet Access services. It indicated that it had 13 buildings being served at less than 10 Mbps, 364 buildings being served at between

²⁰⁸ <http://www.flrnet.org/>; <http://k20.internet2.edu/>; <http://www.sox.net>.

²⁰⁹ The picture could change, as some applications likely were not processed as of the report date and some disbursements could be recovered through the E-rate program's COMAD process.

10 Mbps and 200 Mbps, and 5 buildings being served at greater than 200 Mbps. In the *Sixth Report and Order*, the FCC revised the Form 471 to require a more detailed breakdown of Internet connection speeds, so future USAC information will reveal a more granular picture of broadband connectivity. Finally, while most solicitations were received for wired broadband services, it is clear that some are moving into wireless connectivity as their main broadband source.

Table 10-1. Comparison of E-Rate Performance for Florida and Comparator States, 1998-2009

State	Total Program Commitments 1/1/98 – 12/31/09 (\$000)	Total Program Disbursements 1/1/98 – 12/31/09 (\$000)	Disb/Comm	Number of Elementary and Secondary Public Schools, 2008-09	Number of Elementary and Secondary Public School Students, 2008-09 (000s)	Estimated Annual Disbursements per Student	Per Capita Income, 2009
FL	\$845,473	\$600,457	71%	4,491	2,631	\$19.02	37,780
NY	\$3,511,458	\$2,170,671	62%	4,717	2,741	\$65.99	46,957
OH	\$858,880	\$583,706	68%	3,968	1,817	\$26.77	35,381
PA	\$862,942	\$661,170	77%	3,280	1,775	\$31.04	39,578
IL	\$1,143,839	\$809,229	71%	4,450	2,120	\$31.81	41,411

Sources: Universal Service Administrative Company, 2009 Annual Report. U.S. Department of Education, National Center for Education Statistics, “State Education Data Profiles.” Information Please Database, “Per Capita Personal Income by State,” citing U.S. Department of Commerce, Bureau of Economic Analysis, “Survey of Current Business.”

Higher speed connectivity to schools and libraries appears to be needed. A recent FCC survey indicated, “78 percent of E-rate recipients say they need faster connections to meet the speed and capacity demands of their students, teachers, and library patrons.”²¹⁰ For Florida and the rest of the nation, broadband connectivity in public schools is critical for instruction and might be considered much the same as electricity and other utilities needed for a school’s operations. For example, Clearwater High School plans to replace textbooks with the Amazon Kindle Portable E-book Readers at a cost of \$600,000. The school is negotiating with Amazon Kindle to supply its student body of 2,100 with Kindles.²¹¹

²¹⁰ Federal Communications Commission, “FCC Enables High-Speed, Affordable Broadband.”

²¹¹ Catalanello, Rebecca, “Florida High School Ditches Textbooks.”

Arguably, Florida should make every effort to maximize its use of E-rate support for eligible schools and libraries. Florida is a net exporter of Universal Service Fund (USF) monies: E-rate is one of four federal Universal Service programs that distribute funds, and those programs are funded by telecommunications carriers through fees imposed on interstate and international telephone customers. In 2009, telecommunications carriers serving Florida contributed \$495.8 million for universal service support but Florida received only \$221.9 million from the four USF programs, for a net loss to Florida of \$273.9 million.²¹² Therefore, any measures to increase participation by eligible schools and libraries in the E-rate program would seem advisable.

DMS has taken steps to improve Florida's participation in E-rate. Since DOE ceased providing consolidated E-rate support services and functions in fiscal year 2010, DMS has taken steps to provide these services and functions for requesting schools and libraries. DMS has obtained federal grant funding for a "Broadband Program Office," which among other functions will "establish a Florida E-Rate Team to assist and coordinate support to schools, libraries and health care entities that seek federal grants provided through Universal Service Fund programs such as E-rate."²¹³

²¹² Federal Communications Commission, *Universal Service Monitoring Report CC Docket N. 98-202*.

²¹³ Department of Management Services, *Division of Telecommunications Business Model*, page 11.

11 Financial Modeling to Assess Options for Delivery Models

The cornerstone of our quantitative analysis is the financial modeling conducted for this study. We begin with recent and current spends on broadband services. Table 11-1 provides the total annual expenditures for the three major broadband suppliers in state government in Florida. Table 11-2 shows the amounts billed to state government customers of DMS.

Table 11-1. Total Fiscal Year Broadband Expenditures by Major State Broadband Suppliers in Florida, 2006-2010

Services	Entity	Fiscal Years			
		2006-07	2007-08	2008-09	2009-10
FIRN	DMS	\$ 6,725,161	\$ 9,284,165	\$ 8,286,174	\$ 4,040,118
GMAN	DMS	\$ 2,744,352	\$ 2,896,837	\$ 2,781,157	\$ 2,829,008
MFN	DMS	\$ 162,644	\$ 23,708,811	\$ 37,723,638	\$ 39,339,814
Routers	DMS	\$ 12,226,472	\$ 4,535,314	\$ 393,616	\$ 297,800
Frame Relay	DMS	\$ 27,797,651	\$ 13,618,988	\$ 1,057,645	\$ 22,258
ATM	DMS	\$ 3,881,630	\$ 2,750,049	\$ 211,928	\$ 7,346
Dedicated Data	DMS	\$ 813,941.14	\$ 922,055.26	\$ (166,056.13)	\$ (815.49)
FLR	FLR	\$ 5,318,732	\$ 5,225,263	\$ 4,952,940	\$ 5,000,000
FDOT ITS	n/a	n/a	n/a	n/a	n/a
Total		\$ 59,670,583	\$ 62,941,482	\$ 55,241,042	\$ 51,535,529
Total DMS	DMS	\$ 53,537,910	\$ 56,794,164	\$ 50,454,158	\$ 46,536,344

Sources: DMS provided data for FIRN, GMAN, MFN, Routers, Frame Relay, ATM, and Dedicated Data; FLR data for 2006-07, 2007-08, and 2008-09 are from FLR's Form 990s filed with the U.S. Internal Revenue Service for 2007, 2008, and 2009; FLR data for 2009-10 are the authors' estimates. Data were unavailable from FDOT ITS.

Table 11-2. Total Fiscal Year Broadband Billings by DMS to State Government Customers, 2006-2010

Services	Billed by	Fiscal Years			
		2006-07	2007-08	2008-09	2009-10
GMAN	DMS	\$ 2,436,516	\$ 2,540,260	\$ 2,367,556	\$ 2,470,088
MFN	DMS	\$ 162,644	\$ 22,620,167	\$ 34,311,060	\$ 33,497,447
Routers	DMS	\$ 10,539,475	\$ 3,565,847	\$ 307,863	\$ 180,891
Frame Relay	DMS	\$ 27,693,149	\$ 13,490,602	\$ 1,041,051	\$ 22,258
ATM	DMS	\$ 2,050,058	\$ 1,439,960	\$ 122,931	\$ 4,674
Dedicated Data	DMS	\$ 565,715	\$ 565,941	\$ (328,268)	\$ (5,322)
FLR	FLR	\$ 3,548,000	\$ 3,485,753	\$ 2,530,816	\$ 2,555,000
Total		\$ 46,995,557	\$ 47,705,530	\$ 40,353,009	\$ 38,725,036

Sources: DMS provided data for FIRN, GMAN, MFN, Routers, Frame Relay, ATM, and Dedicated Data; FLR data for 2007-08 and 2008-09 are from FLR's Form 990s filed with the U.S. Internal Revenue Service for 2008 and 2009; FLR data for 2006-07 and 2009-10 are the authors' estimates using the ratios of the adjacent years to estimate state university revenue to FLR.

Tables 11-1 and 11-2 identify trends in government broadband provisioning and use. The DMS expenditures show that MFN is growing, apparently replacing routers, frame relay, and ATM. Overall DMS's expenditures have declined the past three fiscal years, consistent with the price trends for MFN and the substitution of less economical services for more economical services. Included within this overall expenditure decline is some agencies' expansion of capacity using opportunities provided by the transition to MFN. For example, in the transition, FDLE changed from general use of 56kbs access links to T-1 access links. FLR's revenues declined about 6 percent during the time period covered by the table. Also, DMS's percent of the total expenditures increased during the three years for which we have data for FLR: It was 89.7 percent of the total in the first time period, 90.2 percent in the second time period, and 91.3 percent in the third time period.²¹⁴ This growth of DMS relative to the total results in part from the decreasing FLR revenues, but also from the growing importance of sales to non-state government customers for DMS. In fiscal year 2006-07, non-state customers accounted for 7.8

²¹⁴ We do not draw conclusions about DMS's share of the fourth time period because the FLR expenditure is our estimate.

percent of DMS's revenue, but by fiscal year 2009-2010 that percent had grown to 13.6 percent. FLR had also expanded its revenue base during the period represented in the tables – its revenue from non-primary members grew from \$399,098 in 2008 to \$1,505,285 in 2009 – but its revenue from its primary members decreased \$1,303,322 or 27.6 percent, which more than offset the increase in non-primary member revenue. FLR revenue from state universities declined more than FLR's overall revenue: In 2007-08 state universities made up 67 percent of FLR's revenues, but only made up 51 percent in 2008-09.²¹⁵

A basic question for this analysis is whether the State of Florida would be financially better off with a different delivery system for governmental entities to obtain broadband services. In Vol. II SD Sec. 13, we describe in greater detail the approach we take toward modeling the financial impacts, including the methodology used.

11.1 Scenarios

For our analysis we examined five scenarios for ways in which governmental entities procure and use broadband:

11.1.1 Scenario 1: Present Method of Operation (PMO)

This scenario projects costs for the next five years assuming that the state makes no changes to its current practices for obtaining broadband and that current demand, price, and technology trends continue.

11.1.2 Scenario 2: Leveraging Dark Fiber with Continued Premium Service

The second, third and fourth scenarios examine increased insourcing of broadband by state government. In this scenario, the state maintains the quality of service provided by today's MFN and leverages existing fiber at less than a market-based price.

11.1.3 Scenario 3: Leveraging Dark Fiber with Increased Client Service Options.

This scenario examines increased insourcing and permitting state agencies to purchase a quality of service that is different from that which is provided by today's MFN, and leverages existing fiber at less than a market-based price.

11.1.4 Scenario 4: Insourcing Market-priced Dark Fiber

This scenario examines increased insourcing with the assumption that the state leverages existing fiber, but at a market-based price.

²¹⁵ FLR revenue data are from FLR's Form 990s filed with the U.S. Internal Revenue Service for 2007, 2008, and 2009.

11.1.5 Scenario 5: Traffic Aggregation

This scenario enables users to aggregate their connections to the MFN backbone. We assume in this scenario that clients continue to obtain customer premise equipment from DMS. An important caveat for this scenario is that we assume that current prices for MFN remain unchanged.

11.2 Modeling Approach

11.2.1 Probabilistic Modeling

Our modeling approach does not attempt to give a definitive financial impact of a policy change because there are too many unknowns and too many ways in which any particular policy change might be designed and implemented. Our approach is probabilistic, meaning that we formally incorporate uncertainty and look for patterns and orders of magnitude.

11.2.2 Top-Down

There are two basic approaches that could be used to estimate the financial impacts of changing how Florida governmental entities procure broadband. One method is the bottom-up method. This method identifies the processes, facilities, and the like that are needed to supply specific broadband services, estimates costs of each item, and rolls up the costs into various levels of aggregation. The other method is the top-down method, which begins with today's actual costs and focuses on ways in which these costs could change if policies were changed.²¹⁶ We use the top-down method because it begins with current reality, relies on only assumptions about how much reality might change, and requires only aggregate data. Furthermore we believe this is appropriate because the research question looks at how total cost could be impacted by macro changes in the delivery model for broadband.

11.3 Cost Impacts of Delivery Model

Our modeling approach addresses differences between government enterprises (which we call state-owned enterprises or SOEs) and privately owned enterprises. We consider government self-supply to be, in effect, the development of a government enterprise that supplies service to governmental users. Government enterprises often have different costs than privately owned companies, resulting from differences in principal-agent problems, opportunism, cost of capital, taxes, and the like. The body of research comparing efficiency of SOEs to privately owned businesses finds that SOEs are less efficient because of principal-agent problems, opportunism, and less focus on cost containment.²¹⁷ We make the conservative assumption that this efficiency

²¹⁶ Jamison, "Cost Concepts for Utility Regulators."

²¹⁷ See, for example, Villalonga, "Privatization and Efficiency," 43-74.

difference applies to expenses and not to capital. This might understate the cost of insourcing.

Regarding taxes, there are some taxes that SOEs would not pay that a privately owned operator would pay, including income taxes and, in some instances, ad valorem, property, and sales taxes. This advantages tax treatment could make the SOE appear less expensive than a private operator. However, insourcing does not diminish the overall tax burden on citizens, it simply shifts it from customers of the private operator to others. In recognition, we include taxes in our cost estimates just as if the SOE were paying all the taxes the private carriers pay.

Central to our analysis is an adjustment factor that is needed to align private-sector provisioning of broadband to that of SOEs. Our analysis shows that whenever the SOE is no more than 8.76 percent less technically efficient than a privately owned operator, then insourcing would appear to be a more economical option than outsourcing. However, this results from the insourcing option ignoring taxpayers' cost of money. If it is at least as costly, from a citizen's perspective, to relinquish dollar in taxes as it is to relinquish a dollar to a private entity, then insourcing is always more costly than outsourcing unless the government as an operator is more technically efficient than a private business, or if the government for some reason has access to assets at below market prices (such as might be the case with leveraging FDOT dark fiber), or both.

11.4 Financial Modeling Results

As we present our modeling results in detail in Volume II, we limit our discussion here to the general outcomes and patterns that we observe.

We estimate that the cost of broadband for all governmental entities in Florida during the next five years will be approximately \$186 million for state agencies covered by Chapter 282, \$25.6 million for universities and others for FLR and \$2.4 million for universities for MFN, and between \$103 million and \$140 million for local governments under the present mix of delivery models. Our estimate for K-12 is about \$70 million during the five-year time period, but it could be too high given the difficulty of isolating broadband costs for K-12.²¹⁸

Our modeling scenarios primarily impact the entities obtaining service from MFN and GMAN. Table 11-3 presents these findings.

²¹⁸ As we describe in Volume II, we estimate the annual broadband expenditures for public and charter schools to be between \$6 million and \$17.8 million. The broad range results from the complexity of the data. The low estimate is what K-12 pay for FIRM, but FIRM does not necessarily serve all school broadband needs. The higher number probably includes some non-broadband telecommunications costs, such as payments for mobile phone service. Using the midpoint of \$13.9, we obtain a midrange expected spend of \$79.5 million during five years, which we round down to \$70 million to reflect declining broadband prices.

Table 11-3. Scenario Results for Entities Purchasing MFN and GMAN

SCENARIO	DESCRIPTION	RESULTS
Scenario 2	Leveraging Dark Fiber with Continued Premium Service	Decreases costs approximately 1 percent
Scenario 3	Leveraging Dark Fiber with Increased Client Service Options	Decreases costs approximately 4 percent
Scenario 4	Insourcing Market-priced Dark Fiber	Increases costs, but the increase is less than 1 percent on average over 5 years.
Scenario 5	Traffic Aggregation	Decreases expected costs approximately 2 percent on average over 5 years, but could increase costs depending on the effects on access prices.

According to our results, the impacts of the scenarios are modest. This is in part because trade-offs sometimes lower costs and sometimes raise costs. However, the primary reason is that we assume that the scenarios impact only a portion of the MFN and GMAN customers. For example, we think it is unreasonable to assume that a large portion of the usage of the customers could be served by obtaining dark fiber at below market prices. Rather we believe that this could be done for only a modest number of these customers because of the complexity of interconnecting insourced and outsourced networks.

We find that leveraging underutilized dark fiber at below-market prices (Scenarios 2 and 3) could result in some cost savings. However, there is a caveat, namely that the appearance of cost savings results from taxpayer-provided capital being viewed as costless in the budgeting process and the assumption that fiber is currently being underutilized. If these assumptions do not hold, then the insourcing increases costs, as illustrated in Scenario 4. Scenario 4 shows a slight increase in costs relative to the PMO because of decreased efficiency (SOE efficiency relative to privately owned firms). Scenario 4 does not adjust for the missing cost of taxpayer-provided capital, so from a taxpayer perspective, Scenario 4 understates costs.

Scenario 5 results depend upon whether the price structure for ports are impacted by adding port sharing to the features of the MFN and GMAN contracts, and upon whether there are cost savings in access. Our modeling results assume that the current price structure for MFN remains unchanged. This is unlikely to hold if contacts were changed because the private carriers that provide MFN would likely choose a different price structure for ports if government clients had

more options.²¹⁹ This change is likely because prices in the private sector reflect both costs and demand elasticities, which are the indicators of how much customers respond to price changes. The option of sharing ports gives customers more choices, which enables them to be more responsive to prices. This change in responsiveness would generally be expected to lead to a change in prices.²²⁰

²¹⁹ Laffont and Tirole, *Theory of Incentives in Procurement and Regulation*, 165-209.

²²⁰ This is not to say that the overall price level would change. Only that the relationships among individual prices would likely change, resulting in different cost savings from aggregation than we calculate for our analysis.

12 Conclusion

Our conclusions regarding strategic planning for government broadband in Florida focus on five aspects of the challenge of providing broadband services. The first aspect is the planning function itself. We identify multiple levels of planning, including an overall strategic plan, enterprise-level plans (such as is done by AEIT for state entities for IT), provider plans (such as is done by DMS for MFN or by FLR for universities), and client plans (such as is done by Chief Information Officers or CIOs in government agencies). The lack of an overall strategic plan for Florida prompted this study in part, and our research found that this deficiency resulted in inefficiency and confusion. For example, we found conflicts and disagreements about who can and should plan broadband for state government entities, and the scope of authority of various entities. We suggest that policymakers resolve this ambiguity by developing an overall strategic plan that covers governmental entities in Florida for all ICT, and that contains the following sections:

12.1 Section 1: Goals and Objectives

This section would set out clearly at a high level the state’s desired outcomes for governmental use of ICT, including broadband. The goals would explain priorities for operational efficiency, value and effectiveness of governmental services, and taxpayer impacts.

12.2 Section 2: Service Delivery Models

This section would set out how governmental entities would obtain broadband services, including the various forms of insourcing and outsourcing that governmental entities should follow.

12.3 Section 3: Collaboration and Centralization

This section would address how governmental entities join together or not to procure and use broadband. The section should identify barriers that prevent effective collaboration and ways to resolve or overcome those barriers.

12.4 Section 4: Performance Assessment

This section would set out how implementation of the strategic plan by various government actors, and vendors will be assessed, and how those assessments will be used to update the strategic plan and the associated implementation practices.

12.5 Section 5: Governance

This section would describe the division of authority and accountability to be followed across governmental entities in order to implement the strategic plan, and how decision-makers will be held accountable for their decisions.

The second aspect is the service delivery model that is largely an issue of insourcing and outsourcing. In general, we find that outsourcing is more efficient for taxpayers than insourcing, but there are many reasons for exceptions. In some instances, private operators experience their own budget or other constraints, and so do not have services available when and where governments want them. This was the experience of GRU and Shands that led to the formation of GRUCom. We conclude that a general preference for outsourcing is in order, with sufficient flexibility to address situations where services are unavailable or market competition is not strong enough to provide competitive prices, and with constraints on that flexibility. In this manner, various problems, such as governmental budgeting limitations, principal-agent costs, and political interference, do not lead to inefficient levels of investment in government-owned facilities.²²¹

The degree of centralization is the third aspect of the challenge. Florida has a largely decentralized approach, leading to numerous diverse approaches to broadband provisioning by local governments, institutions of higher learning, K-12, ITS entities, and others. Decentralization may have its costs, such as uneconomic duplication and missed opportunities to leverage the power of joint bargaining for procurement. However, these costs relate more to a static environment than to the rapidly changing technology and service environment we are now experiencing. Indeed, we found that the diverse approaches to broadband provisioning facilitate rapid change, experimentation, and learning. These dynamic efficiencies can dominate static efficiencies in times of rapid change.

The fourth aspect is innovation or flexibility at the edges of the models. We found that in some circumstances it can be economical to deviate from the chosen delivery model. For example, an outsourcing model can be made more efficient if there are opportunities to leverage underutilized facilities, such as might occur when a governmental entity has a network with excess capacity or when a private entity has overbuilt its network. Likewise an insourcing model can be made more efficient with interconnection, such as is being explored by FLR and DMS.

Governance is our fifth aspect. Florida has a governance system in place for broadband, but we have concluded that enterprise-level planning for all ICT should be implemented and kept functionally separate from operations and provisioning of broadband. We also found disagreement regarding who had authority to provide enterprise-level planning for broadband, and suggest policymakers resolve any ambiguity regarding planning roles and authority.

²²¹ One aspect of the delivery model that was not included in our scope of work, but that arose several times in our discussions, was the method of contracting for services such as MFN. Currently each of these services has a single outsourcing contract. Some believe that a multivendor contract might improve service pricing and performance. We did not investigate this issue and do not hold an opinion on whether this issue should be reviewed by policymakers. We note that optimal contracting is a very complex issue and that the answer as to which contract form is best is very sensitive to the context.

Our general finding is that the efficiency and effectiveness of government broadband service procurement in Florida would not be significantly impacted by changes in the delivery model. Indeed, we could find no compelling reason to change the degree of centralization or the modes of insourcing and outsourcing currently in practice. This is not to say that this conclusion would not change if circumstances changed. Features of the landscape for broadband supply and demand, such as customer needs, the pace of technology change, the ability of government to operate efficiently, and the like do change and could justify a reassessment sometime in the future. While overall changes to the delivery model should be evaluated at the macro level, as we do in this report, specific situations that deviate from the delivery models designated by policymakers should be subjected to economic analysis on a case-by-case basis to ensure that taxpayers benefit.

Volume 2 – Supporting Documents

The material in this volume of the Report on Strategic Planning for Florida Governmental Broadband Capabilities supports the conclusions, recommendations and options for action discussed in Volume 1.

13 Financial Modeling for This Report

This section supports the recommendations on insourcing and outsourcing found in Volume 1.

A basic question for this research is whether the State of Florida would be financially better off with a different delivery model for governmental entities to obtain broadband. The two basic sourcing approaches in use today by Florida governmental entities are insourcing (e.g., Florida Department of Transportation (FDOT), Florida LambdaRail (FLR), and Gainesville Regional Utilities' communications arm, GRUCom) and outsourcing (e.g., MyFloridaNet or MFN).²²² With rare exceptions, the corresponding networks do not share resources. There are several other models in use by local governments, which are essentially variations on the basic insourcing and outsourcing approaches, but also involve different forms of collaboration. For example, the city of Fort Pierce obtains broadband from its own network and from MFN, and engages in infrastructure sharing with other network owners. The city of Gainesville purchases broadband from its municipal utility, which also sells broadband on a commercial basis.

A determination of financial effectiveness should address two basic questions. First, can the government lower its broadband costs if different approaches were used, e.g., if the state insourced more of its broadband, engaged in greater integration of facilities, or both? These costs include such things as amounts paid for broadband services and costs borne by governmental entities to obtain, manage, and use the broadband services. Costs for obtaining broadband services include planning, bidding, and contracting activities. Costs for managing include ongoing costs for managing and enforcing contracts, service ordering, and service reconfiguration. Costs for managing broadband also include billing costs if there is resale of service between governmental organizations, such as is the case of the Department of Management Services (DMS) billing state agencies for MFN. Costs for using broadband services could include training and equipment not included in the broadband services contracts. From this view of cost, the cost effectiveness of broadband for major state entities are declining even under the present method of operation: Expenditures by DMS for all data services declined 18 percent from fiscal year 2007-08 to fiscal year 2009-10, and state university payments to FLR declined 23 percent from fiscal year 2007-08 to fiscal year 2008-09, even though indications are that

²²² As we note in Volume 1, many networks are hybrids of insourcing and outsourcing. FLR is an example. FLR leases dark fiber and other core facilities, but operates its network.

usage increased.²²³

Our second basic question is, how can broadband change the overall cost and effectiveness of government, including the substitution of IT for people, paper, transportation, and other aspects of operations, and the reorganization of governmental functions? This is a more transformative question and goes to the heart of how broadband can substitute for other inputs to government services, such as travel and labor, and how broadband can change the nature of government services, such as the role of libraries serving as places for people to search online for jobs during the current economic downturn.

We limit our research to estimating the direct effects of possible delivery model changes on amounts paid for broadband services.²²⁴ In some ways, this limit makes our results conservative estimates of financial impacts of alternative policies because any change in amounts paid for broadband services would be amplified if governmental entities substitute broadband for other inputs to government services and use broadband to transform how services are provided. For example, a decrease in costs for broadband could lead a cost-efficiency-minded manager to use less travel and more video conferencing for meetings involving employees from multiple locations, all other things being equal. A less centralized process for obtaining broadband, such as diminishing DMS's role as a central procurer of broadband or dissolving FLR as a central broadband provider for universities, may increase transaction costs by increasing the number of contracts into which governmental entities would enter. For this reason and others recommend policies that enhance opportunities for collaboration and coordination among governmental entities, such as information-sharing that enhance such opportunities, without limiting opportunities for individual entities to innovate and address unique circumstances. Presumably government chief information officers are motivated and have the skills to make economical trade-offs between costs for planning and contractual bidding given the opportunity and sufficient information.

One caveat to the above is that some managers may not be efficiency minded. For example managers might not put forth sufficient effort to save costs or might avoid collaborations in order to protect their turf. These are called moral hazards because it is costly for taxpayers and their political representatives to monitor such problems and ensure that managers are acting in taxpayers' best interests. More generally such problems are called principal-agent problems and arise from managers (called the agents) knowing more about their abilities and efforts than do

²²³ Sources: DMS billing data for FIRN, GMAN, MFN, routers, frame relay, ATM, and dedicated data; FLR Forms 990 for years 2008 and 2009. Underlying data are shown in Tables 11.1 and 11.2 in Volume 1.

²²⁴ By "delivery model" we mean the arrangements used to obtain broadband, including the insourcing/outsourcing arrangement. Another term is sourcing model.

the taxpayers and politicians (the principals).²²⁵

We discuss below how the principal-agent problem impacts the efficiency of governmental entities. Our focus here is how the principal-agent problem impacts the economics of centralization of broadband supply. One possible impact is that there might be fewer monitoring costs with the centralized approach relative to a decentralized model because there are fewer agents to scrutinize.²²⁶ However, the decentralized approach enables the benchmarking of managers against each other, which lowers monitoring costs because information asymmetries are reduced.²²⁷ For example, we found that the work being done by local governments on broadband provides insights into costs that might be incurred for insourcing by other governmental entities. Also, a larger number of agents increases opportunities for experimentation and learning. Information sharing increases these impacts. Based on these reasons and the research we cite below, we believe that principal-agent problems impact the economics of obtaining broadband, but we do not believe that degree of centralization/decentralization at issue in our research meaningfully impacts the principal-agent costs. Therefore, we do not incorporate possible differential principal-agent effects for centralized versus decentralized purchasing scenarios in our financial modeling.²²⁸

13.1 Modeling Approach

13.1.1 Probabilistic Modeling

Our modeling approach does not attempt to give a definitive financial impact of a policy change because there are too many unknowns and too many ways in which any particular policy change might be designed and implemented. Our approach is probabilistic, meaning that we formally incorporate uncertainty and look for patterns and orders of magnitude rather than emphasize point estimates. For example, one policy change might be to enable entities subject to Chapter 282 choices in the ways in which they obtain access to the MFN core network. We do not know precisely what pricing and service options these entities would have or how many of these

²²⁵ Laffont and Martimort, *Theory of Incentives*, 3.

²²⁶ However, to the extent the centralized supplier is not only an agent for the politicians, but also for the government agencies, the monitoring costs could increase. For example, government users of broadband might question the central supplier's efficiency and methods of charging.

²²⁷ Laffont and Tirole, *Theory of Incentives in Procurement and Regulation*, 84-86.

²²⁸ One issue that was raised in our research was whether the principal-agent issue indicated that centralized supply of broadband to governmental entities was needed because different agents (city government, county government, various state agencies, and the like) would have different missions and may not jointly optimize their broadband use. The fact that the primary principal (citizens) may have different missions for different agents (city government, county government, various state agencies, and the like) does not limit these agents' abilities to coordinate and optimize across boundaries. Indeed we found cases where separate government entities engaged in coordinating activities.

entities would choose something besides the status quo. To address these uncertainties, we treat the alternative prices and take rates as variables whose precise future values are unknown, but that we can expect the values to fall within certain boundaries and probabilities. This approach results in a range of possible financial impacts of the policy, with probabilities assigned to each possible outcome. Based on these results, we can examine expected financial impacts and the risks involved for each policy scenario that we examine.²²⁹

13.1.2 Bottom-Up versus Top-Down

There are two basic approaches that could be used to estimate the financial impacts of changing how Florida governmental entities obtain broadband. One method is the bottom-up method. This method identifies the processes and facilities that are needed to supply specific broadband services, estimates costs of each item, and aggregates the costs into various levels. The other method is the top-down method, which begins with today's actual costs and focuses on how these costs could change if policies were changed.²³⁰ Our research uses the top-down approach.

The bottom-up method is attractive because people can see how the costs are constructed and it appears factual. However, this method presents several challenges. One challenge is that the method is subjective in that the modeler must project the types, quantities, configurations, and prices of all of elements of providing broadband service. Experience with bottom-up regulatory cost models for telecommunications is that modelers consistently underestimate the costs that network providers actually incur. There could be several reasons for consistently low estimates, but one problem for modelers is that they do not know everything that the people on the ground know. Modelers also cannot fully anticipate future problems with building and running a network. As a result, a bottom-up model misses some of the realities of providing broadband services. Another challenge of a bottom-up approach is that it is data-intensive: The modeler must know quantities, prices, and other features of all of the facilities, people, etc. that an organization would need to supply broadband. We do not have such data for this study. A third challenge with a bottom-up approach is that the details become the focus of controversy, both because there are any number of reasonable assumptions that could be made in network technology, network architecture, facility utilization, among others, and because controversies over details divert attention from realities in the bigger picture.²³¹

The top-down method is more attractive than a bottom-up method for this study because a top-down approach begins with current reality, only relies on assumptions about how much reality might change, and requires only aggregate data. However, the method has challenges. One

²²⁹ More specifically, we treat the alternative prices and take rates as stochastic variables with means and variances chosen from either existing research or expert opinion. We explain each stochastic variable below.

²³⁰ Jamison, "Cost Concepts for Utility Regulators."

²³¹ Jamison, Mark A. "The Role of Costing as a Ratemaking Tool," 250-275.

challenge is the difficulty of estimating impacts of substantial changes in technologies and architectures, such as a move from fiber optics to wireless or from server-client computing to cloud computing. It is also difficult to show granular results because the data sources, such as accounting and billing records, are aggregated.²³²

13.2 Policy Scenarios

Current approaches for obtaining broadband result in four basic models in Florida.²³³ One is a build-own-operate (BOO) approach basically used by FDOT for its Intelligent Transportation System (ITS).²³⁴ In this approach, FDOT constructs its own ITS network with financial assistance from the federal government. FDOT owns and operates the facilities. A second approach is a combination of BOO and lease-operate used by FLR. FLR leases dark fiber from private network operators, invests in communications equipment, adds its own network management facilities, and manages the resulting network.

The third approach is outsourcing, which DMS uses in placing MFN for bid to private carriers. The winning carrier provides core network, access, and premise equipment (CPE) services to DMS, and DMS then sells these services to other governmental entities. The prices paid by the end users cover what DMS pays the carrier for MFN, and the costs DMS incurs as the procurer and manager of the services.

The final approach is a mixed approach used by local governments. Some local governments, such as the City of Gainesville, use a BOO system. For example, the city-owned Gainesville Regional Utilities has a communications group called GRUCom that owns and operates a network. Other local governments completely outsource their broadband. Increasingly local governments are using a mix of BOO and outsourcing, and many include facility sharing with other network owners.

We examine three basic settings for how governmental entities obtain broadband and further divide our analysis into five scenarios. The first setting assumes the current outsourcing approach for DMS continues. We analyze this in *Scenario 1: Present Method of Operation (PMO)*. This scenario projects costs for the next five years assuming that policymakers make no changes to current policies and that current demand, price, and technology trends continue.

²³² Jamison, “Cost Concepts for Utility Regulators.”

²³³ Our descriptions of FDOT, FLR, DMS, and GRUCom are simplified in this section. We describe each in more detail in Vol. II SD Sec. 14 and Appendix III.

²³⁴ At the present time, Florida’s ITS is not a network in the normal sense of the word when it is used to denote a network such as the Internet or MFN. A network is a system of links and nodes over which traffic flows amongst the nodes. ITS is better characterized as a system of cables connecting traffic monitoring and management instruments. FDOT is working to implement Wide Area Networking (WAN) over its ITS facilities.

The second basic setting involves three possible scenarios for increased insourcing of broadband by the state government. More specifically we examine what might happen if the primary outsourcer, DMS, leveraged network facilities owned by other governmental entities, such as FDOT, local governments, or FLR, and what might happen if DMS leased²³⁵ dark fiber from a private entity.²³⁶

Our three scenarios in this setting are: (1) Scenario 2: Leveraging Dark Fiber with Continued Premium Service; (2) Scenario 3: Leveraging Dark Fiber with Increased Client Service Options; and (3) Scenario 4: Insourcing Market-priced Dark Fiber. Scenario 2 considers the situation where some portion of the broadband services outsourced by DMS are insourced, that the fiber optics used are leveraged from existing government sources at discounted rates, and that service qualities and features in the current MFN/GMAN²³⁷ supply remains unchanged. Scenario 3 is like Scenario 2, but includes opportunities for customers who obtain service from the insourced portion of the network to choose lesser service qualities and features than currently provided. Scenario 4 is like Scenario 3, but assumes that the fiber optics used is obtained at compensatory market prices. We do not describe technically how increased insourcing might work because the approach that would be used in practice would depend upon contract changes for the MFN, fiber availability, DMS operational choices, and client choices. Rather than make assumptions about the details of the ways in which increased insourcing might be done, we examine general effects of changes in the amount of insourcing and outsourcing that might be done by DMS.

Implicit in scenarios 2 and 3 is the notion that existing governmental entities have underutilized capacity in their networks. This might occur for four reasons. One reason is that a governmental entity might uneconomically install too much capacity, either because of poor planning or because of a change in the economy once investments are committed. A second reason is that the installation of excess capacity is essentially costless in some settings, so that the excess capacity has an option value that makes it economical to create.²³⁸ The third reason why a governmental entity might have spare capacity is that its capacity was installed to be optimal over a long time horizon, such as 20 years, and that for some portion of that time horizon the governmental entity does not need all of the installed capacity for its own needs. The last reason why a government entity may have spare capacity is rapidly changing technology. A single fiber pair 5 years ago might have been required to provide 1 Gbps of bandwidth. Today it is not unusual for a single

²³⁵ Engaging in fiber swaps is an alternative to leasing. Some governmental entities are engaged in swaps. We do not consider that as an alternative for DMS because it has no fiber facilities at this time to use in a swap.

²³⁶ Alternatively, we could model the impact of FLR leveraging FDOT fiber optics or the fiber optics of local governments. We do not have sufficient information on FLR's existing fiber leasing arrangements to address this issue.

²³⁷ GMAN is a metropolitan area network service offered within MFN.

²³⁸ This was a common reason stated by governmental network managers for sharing network facilities or increasing their customer base.

fiber pair to provide 40 or more Gbps of bandwidth.

Our final setting is our fifth scenario. It includes opportunities for enables users to aggregate their connections to the MFN core network. For example, government clients might join together and purchase access from a regional network, a local government network, or FLR, and connect their combined traffic to the MFN core network through a single shared port.²³⁹ We assume in this scenario that clients continue to obtain customer premises equipment (CPE) from DMS. This assumption focuses our analysis on network issues. We call this setting *Scenario 5: Traffic Aggregation*.

An important caveat for the Traffic Aggregation Scenario is that we assume that the current price structure for MFN remains unchanged over the course of our simulation. This is unlikely to hold in practice because the private carriers that provide MFN would likely choose a different price structure if government clients had more options.²⁴⁰ More specifically, enabling clients to aggregate their traffic and share a port into the MFN core network changes how responsive clients are to port prices, i.e., the option of sharing ports gives clients more choices, which enables them to be more responsive to prices, i.e., their demand becomes more price-elastic. Service providers consider customer price responsiveness in establishing prices, so different price responsiveness would generally be expected to lead to different prices, perhaps eliminating some of the savings from aggregation that might appear to be possible with current MFN prices.²⁴¹

13.3 Impacts of Ownership on Costs

Some of the scenarios we analyze involve relying on provision of telecommunications services by governmental organizations, including self-supply or insourcing by these organizations, rather than by privately owned businesses. It is commonly accepted in the economics literature that ownership of the means of production, as well as other institutional arrangements such as systems of regulation, impact efficiency.²⁴² The issues affecting efficiency include agency problems, organizational objectives, expropriation, and cost of money. In this section, we explain how these issues affect privately owned service providers differently than they do government-owned entities. We explain below how we incorporate these differences into our modeling. To

²³⁹ It is unclear to us whether port sharing and access options are permissible under the current MFN contract. Rather than draw legal conclusions about the current contract, we allow that this scenario might require clarification by the contracting parties.

²⁴⁰ Laffont and Tirole, *Theory of Incentives in Procurement and Regulation*, 165-209.

²⁴¹ This is not to say that the overall price level would change. Only that the relationships among individual prices would likely change, resulting in different cost savings from aggregation than we calculate for our analysis.

²⁴² Summaries of the literature can be found in Cuervo and Villalonga, “Explaining the Variance in the Performance Effects,” 581-590; Newbery, “Privatising Network Industries;” and Heinisz and Zelner, “Institutional Environment,” 123-147.

ease exposition, we refer to a government-owned network with the more common term, state-owned enterprise (SOE). In doing so we are using the term SOE more broadly than it is commonly used. Normally, a SOE is a government-owned business supplying products or services. We expand the use of the term to include in-house provision of broadband by a governmental entity.

13.3.1 Agency Problems

Agency problems generally cause SOEs to have higher costs than privately owned firms. It is generally accepted that managers (the agents) in both privately owned firms and SOEs have private information about their abilities and effort, and use this information to their own benefit rather than seek to maximize the value they can provide to their organization or its owners (the principals). In privately owned firms, this principal-agent problem is diminished by competitive market forces, such as markets for corporate control and markets for products, and by internal control mechanisms, such as profit sharing and boards of directors. For example, a private enterprise that is subject to competition and that fails to adequately address these information asymmetry problems will lose market share to its more effective rivals, all other things being equal. The competitive process works to diminish and possibly eliminate inefficient firms. Furthermore, the principles can establish economic mechanisms, such as profit-sharing, that help to align the agents' interests with the principals' interests.

Such market forces and internal control mechanisms are largely absent in SOEs, making the agency problem more pronounced than in privately owned firms.²⁴³ For example, effective competition is often lacking for SOEs because governments often protect their own enterprises from competition.²⁴⁴ Also exacerbating the agency problem for SOEs is the doubling of the agency relationships. There are actually two agency relationships in the SOE: one between the public-as-owners and politicians, and one between politicians and government managers.²⁴⁵ The public has limited ability to monitor politicians, which enables political actors to extract value from the enterprise for their own purposes. Politicians, in turn, have limited ability to monitor managers, in part because of the political actors' wide range of interests and responsibilities and their limited technical expertise.

13.3.2 Objectives

The profit motives of privately owned firms also lead them to be more efficient than SOEs. Most privately owned firms have profit motives and, as such, have incentives to improve technical efficiency – i.e., to minimize costs for the quantity and quality of the service provided – and to choose levels of service quality that best induce customers to purchase amounts of service that

²⁴³ Cuervo and Villalonga, "Explaining the Variance in the Performance Effects," 581-590.

²⁴⁴ Edwards and Waverman, "Effects of Public Ownership," 23-67.

²⁴⁵ Cuervo and Villalonga, "Explaining the Variance in the Performance Effects," 581-590.

maximize the service provider's profits, given the costs of providing that quality. The service quality incentive is imperfect, but tends to work well at the margin. SOEs generally lack comparable motives to optimize costs and quality: SOEs' budgets, service output, and service quality are often driven by interests of political actors, subject, of course, to the agency problems described above. The political actors' objectives are often vague, contradictory, and ever changing,²⁴⁶ making it difficult for public managers to pursue technical efficiency, let alone achieve it. As a result, government managers may be pressured to serve political interests. Even when government managers seek to optimize costs and quality, they may be hindered by interventions of political actors that want favors for constituents.²⁴⁷

13.3.3 Expropriation

Expropriation is more commonly referred to as the hold-up problem. With respect to privately owned enterprises, hold-up results from the absence of credible commitments by the government not to expropriate assets or the returns they generate.²⁴⁸ Expropriation occurs in infrastructure services when, once an operator has sunk its investment, the government expropriates the value of that investment. Examples of expropriation include, lowering prices to non-compensatory levels, clawing back profits, or making new demands. For example, the State of Florida instituted laws on the regulatory treatment of investments in nuclear power plants, at least in part, to provide investors with confidence that they could know how the Florida Public Service Commission would treat those investments when setting electricity prices.²⁴⁹ Another example is utility investments in the United Kingdom. When the Labour Party took control of the U.K. government several years after the country had privatized some SOEs, the Labour government behaved opportunistically and instituted a windfalls profits tax to capture some of the profits that the new private owners had received since privatization. This claw-back of profits led some foreign investors to withdraw from the country shortly thereafter.²⁵⁰

As the Florida and U.K. examples illustrate, lack of commitment increases risks associated with investments that: (1) are largely sunk, i.e., that cannot be reversed without significant loss of value; (2) have economies of scale and scope, which decreases the number of operators the political actors have to monitor; and (3) have large political interest, i.e., political actors can attract positive public attention by challenging the recovery of the investment costs.²⁵¹

²⁴⁶ As Robert Dahl observes, "...in most societies, and particularly in democratic ones, ends are often in dispute; rarely are they clearly and unequivocally determined." Dahl, "The Science of Public Administration," 1-11. See also Wilson, *Bureaucracy: What Government Agencies Do*.

²⁴⁷ Newbery, "Privatising Network Industries."

²⁴⁸ Heinisz and Zelner, "Institutional Environment," 123-147.

²⁴⁹ Holt and Kury, "Florida's Plans to Finance New Nuclear Plants," 31-40.

²⁵⁰ Jamison, "1st Academic Conference," 58-87.

²⁵¹ Spiller, "Institutional Changes," 621-655.

Telecommunications networks have these characteristics. Unless properly addressed through strong property rights laws and independent regulatory agencies, the risks of the hold-up problem cause privately owned firms to under invest. In the United States, the hold-up problem is addressed through the Constitutional takings clause, contract law, and regulation of utilities by independent regulatory agencies.

The hold-up problem also exists for SOEs, although there is evidence that the effects are less pronounced than for privately owned firms, at least in the electricity sector.²⁵²

For SOEs, short-term political pressures can lead to budgetary restrictions that benefit current taxpayers, but that also leads to delays in making investments and providing network maintenance. Political actors often promise that money will be forthcoming when the political pressures ease, but the promised budgetary relief rarely arrives. In some instances, the restrictions directly limit investment. In other situations, the knowledge that budgets will be insufficient to provide adequate system maintenance and technology upgrades leads managers to limit their political exposure by restricting the scale of their operations, for example, by limiting coverage and expansions that would depend upon further technology investments.²⁵³

13.3.4 Cost of Money

The nominal cost of money is generally considered to be lower for SOEs than for privately owned firms. This lower cost results from preferential tax treatment afforded some government-issued debt, and from taxpayer-provided capital generally being treated as costless²⁵⁴ by political actors and by government managers when assessing costs.

In general, the cost of capital for an enterprise has two components – the cost of debt and the cost of equity – and their magnitudes are different for private firms than they are for SOEs. The cost of debt, which is the interest paid to lenders or bondholders is different because of differences in risk and of tax treatment.²⁵⁵ Government debt is generally viewed as being less risky than private debt because taxpayers stand behind the debt at least to a certain extent. This is often reflected in SOEs carrying more debt compared to their total assets than do privately held firms. For example, Gainesville Regional Utilities' (GRU) debt is about 90 percent of its total assets, whereas AT&T's debt is only about 30 percent of its total assets.²⁵⁶ So all other things being

²⁵² Cubbin and Stern, "Impact of Regulatory Governance," 115-41.

²⁵³ Savedoff and Spiller, "Government Opportunism," 1-34; Heinisz and Zelner, "Institutional Environment," 123-147.

²⁵⁴ The reference here is to taxpayer provided capital, not debt. Taxpayers certainly often resist paying higher taxes, but their opportunity costs do not show up in government cost calculations in the way that private businesses consider shareholders' opportunity costs.

²⁵⁵ For ease of exposition, we use the term bondholder to refer to all providers of debt.

²⁵⁶ Gainesville Regional Utilities. *Annual Report 2008-2009*, 26; Yahoo Finance, "AT&T Inc., Key Statistics."

equal, the risk-adjusted opportunity cost of money for a bondholder is lower if the money is lent to a SOE rather than to a private firm.²⁵⁷

Taxes affect interest paid by a private firm to its bondholders in two ways. The bondholders pay income taxes on the interest they receive, so their net return is the interest received less taxes paid. Therefore, the interest rate bondholders require from a private firm is equal to the risk-adjusted opportunity cost of money plus taxes. Also, the firm deducts interest paid as a business expense for income tax purposes, so the real interest cost is the interest paid less the taxes avoided. Combining these two tax effects, the cost of debt for a private firm is the risk-adjusted opportunity cost of money plus or minus the difference between the individual and business taxes. Taxes affect interest paid by governmental entities in a different way than they do private firms. For many governmental entities, the interest received by bondholders is tax exempt, meaning that the interest bondholders require is simply the risk-adjusted opportunity cost of money.

Regarding the cost of equity, which is the financial return required by owners of the firm to continue to finance it, the differences between private firms and SOEs can be quite significant. Investment in assets represents a choice to delay consumption in anticipation of the assets providing value beyond what would be experienced if the consumption were to occur today. In the case of private investment, the consumption delay occurs voluntarily when debt providers or shareholders agree to provide the private operator with new capital, allow the operator to continue to use previously provided capital, or permit the use of retained earnings to make further investments. Because these capital commitments are voluntary, the operator must provide the debt and equity providers with expected returns that compensate for risk, opportunity costs for capital, and the taxes capital providers would pay on interest, dividends, and capital gains.

In contrast, SOEs are able to use taxpayer-provided capital. SOEs generally do not incorporate taxpayer risks and opportunity costs when making financial decisions. As one local government official explained, insourcing of networks services is less costly to him than buying from a private network operator because the private operator has to capitalize its investment, meaning that the private operator has to pay back investors for their capital and provide them with a return on net investment, but the local government does not have to compensate the taxpayers who provided capital. The Magellan Advisors report provides additional support for this view: “In many instances, local governments who aggressively pursue broadband in their communities develop sound business cases to build, on a project-by-project basis. They may start with small

²⁵⁷ Stepping away from the “all else equal” condition adds another level of understanding. One reason that debt is less risky than equity is that debt has a higher priority claim to assets and earnings compared to equity. Consider that the debt associated with a project financed with 100% debt will be riskier than the debt associated with a project financed with 50% debt, in a commercial setting. Private firms can’t (or shouldn’t be allowed to) finance with 100% debt, while governments can and do.

projects that have a quick payback and incremental revenues that can be reinvested in additional construction projects. The entity uses these reinvested revenues to continue network build-out, always ensuring a feasible payback period and new incremental revenues.”²⁵⁸

As one might surmise, taxpayer-provided capital is not costless to the taxpayers – it seems reasonable to believe that taxpayers desire just as much return on their invested tax dollars as they do their privately invested dollars, all things being equal – but the risks and opportunity costs to taxpayers are generally not considered costs in government investment planning.

These differences in the cost of equity can make substantial differences in how privately owned firms operate versus SOEs. Said differently, a SOE’s business model often operates more on a cash basis than does a private enterprise. As a result, as another local governmental manager explained, once the taxpayers have paid for the SOE network assets, they are considered to be free from the perspective of the SOE managers.

We use 3.38 percent – the current yield on 10-year municipal bonds as of December 17, 2010 – as our cost of money for a SOE.²⁵⁹ Table 13-1 displays our estimates of the cost of money for privately owned enterprises using the Capital Asset Pricing Model (CAPM). We use AT&T as our representative private telecommunications operator.

13.4 Outputs

Our objective with this financial modeling focuses on possible impacts of policy changes on government budgets. To this end, we express our output in terms of total cost and in terms of who pays the costs. We recognize four basic cost payers: (1) Local taxpayers, such as payers of property taxes, who fund portions of local school budgets and the like; (2) State taxpayers, who pay costs reflected in state budgets; (3) Federal taxpayers and telecommunications ratepayers, who provide funding for federal subsidy programs, such as the federal support for ITS and for the E-rate program;²⁶⁰ and (4) Private organizations that provide subsidies, such as those offered by Google.

²⁵⁸ See Magellan Advisors, LLC, *Local Government Communications Use*, Appendix II.

²⁵⁹ Bloomberg, “Market Data.”

²⁶⁰ E-Rate is one of four programs financed from the federal Universal Service Fund (USF). Revenues providing that fund are generated by an assessment on interstate and international revenues of telecommunication providers. Telecommunication providers generally pass these charges along to their customers. The Federal Communication Commission appointed the Universal Service Administrative Company, (USAC) to administer the four programs and the Universal Service Fund.

Table 13-1. Estimate of Cost of Capital for Private Operator

Line	Item	Amount	Percent
Capital Structure			
1	Short-Term Debt	\$6,426,000	2.70%
2	Long-Term Debt	\$62,540,000	26.28%
3	Equity	\$169,022,000	71.02%
Cost of Debt			
4	Short-term debt		0.76%
5	Long-term debt		3.30%
6	Effective Tax Rate		32.40%
7	After-Tax Cost of Short-Term Debt (L4 x (1 - L6))		0.51%
8	After-Tax Cost of Long-Term Debt (L5 x (1 - L6))		2.23%
Cost of Equity			
<i>Betas</i>			
9	Bloomberg Beta estimate	0.78	
10	Yahoo Finance Beta estimate	0.62	
11	Average ((L9 + L10) / 2)	0.70	
<i>Current Risk Premium</i>			
12	10-year Bond Risk Free Rate		2.59%
13	Average Market Return		10.99%
14	Market Risk Premium (L13 - L12)		8.40%
15	Current Cost of Equity (L12 + L11 x L14)		8.47%
16	Weighted Average Cost of Capital (L1 x L7 + L2 x L8 + L3 x L15)		6.62%

Sources: Yahoo Finance, “AT&T Inc., Key Statistics” and Bloomberg, Database, T US <Equity> <Go>, “WACC Analysis.”

We believe that this approach of expressing costs in local, state, federal, and private categories provides policymakers with information that they might find useful for evaluating policy choices. For example one group of policymakers might be mostly interested in managing total cost, so we provide that estimate. Another group may believe that it should place greater weight on state taxpayers than on other funders. Such policymakers would need information on state budget impacts relative to other budget impacts. However, our estimates are general and specific policy proposals should be analyzed with more targeted estimates.

For example, we consider payments from the Florida Department of Revenue for MFN to be costs to the state budget. However, the Department of Revenue receives federal support for some of its programs and, conceivably, some of this federal money can be used to pay for MFN service. We do not attempt to estimate how much of the department's payments to MFN might come from federal taxpayers.

13.5 Data Sources

Our modeling efforts are hindered by data limitations.²⁶¹ DMS provided full information on its costs based on its billing records and expenditures for four years. However, we were unable to obtain sufficient cost information from FDOT, so we have omitted FDOT's costs from our model. This omission of FDOT costs means that we do not show the total cost for broadband for all governmental customers in Florida. However, most of our policy scenarios do not impact FDOT's costs, so the omission does not hinder our ability to estimate cost changes.

FLR provided limited data. FLR considers much of its financial, pricing, and demand data to be proprietary. We estimate FLR's costs using asset, operating expenses, and revenue data from FLR's annual Form 990 submissions to the U.S. Internal Revenue Service and FLR's annual reports. FLR provided no data on prices and amount of service provided, although member and affiliate locations obtaining service through FLR have been provided (see Section 2.4).

Due to budgetary and time limitations for this project, we did not attempt to obtain complete data regarding local government broadband. Even if we had had sufficient time and budget, we might not have been successful because it may have been costly for the local governments to generate the information and some might prefer to keep some information private, such as contracts with clients. While this limits our cost estimates for what local governments spend on broadband, it does not limit our scenario modeling because it focuses on state government costs.

To compensate for this information gap on local government costs, we use two sources of information to estimate local government broadband costs. One source is MFN billing records. Some local governments purchase broadband from MFN and while we do not know whether they purchase all of their broadband services from MFN, it does provide us with cost benchmarks. We also have complete asset, operating cost, and revenue information from Gainesville's GRUCom, but not demand and price information. GRUCom considers its price and output information to be proprietary. We used GRUCom's cost information to calculate total broadband costs for the City of Gainesville, and used that as our second basis for estimating broadband costs for all local governments in Florida. Our approach to making this estimate is described in more detail later in this report.

²⁶¹ This project and its results are based on voluntary cooperation from the various government operators included. Our results would be more complete had all operators provided sufficient data.

We obtained data on schools and library subsidies to Florida from the USAC web site.

13.6 Estimating Total Cost

As we state above, our modeling begins with today's total cost for broadband used by governmental entities in Florida, including MFN, GMAN, FLR, and local governments. We omit FDOT because of insufficient information. As our information on local governments is incomplete, we perform separate analyses for local and state government.

To ensure that our cost estimates are legitimate for comparing insourcing with outsourcing, we adopt the perspective of a private business that has investors, except that we do not include taxpayers' opportunity costs of capital. In the earlier section about the impacts of ownership on costs, we described how ownership impacts efficiency, namely through differences between SOEs and private enterprises with respect to agency problems, organizational objectives, expropriation, and cost of money. There is another issue that we only alluded to previously, namely the difference in how government and private entities view costs. We explain this by first describing how a private entity views its finances.

A private enterprise examines its finances largely through the use of three basic types of financial statements: A cash flow statement, an income statement, and a balance sheet. The cash flow statement provides information about the source of the enterprise money and how the money is spent. A key concept is free cash flow, which highlights whether the operations of the firm are providing sufficient cash to make investments for the future. The free cash generated belongs to the owners of the firm, but it is less costly for the enterprise to finance investment out of its operations' cash flow than to issue new debt or equity instruments. Another key concept is cash-from-investment, which indicates whether the firm is investing or divesting.

The balance sheet shows everything the enterprise owns (assets) and who has financial claims against those assets (debt and equity). When owners and lenders provide funds to the firm, and these are invested, they are reflected as assets on the balance sheet. The money owed to lenders is reflected as debt, and the value that belongs to the owners is represented as equity.

The profit or loss of a private firm is reflected in its income statement. The revenues shown are those that were earned during the time period represented – normally 12 months – and the costs are those associated with earning the revenue, including the cost of using assets, which is represented as depreciation. Revenue earned is different from revenue actually received because customers may prepay for services or may pay after the service is received. Revenue earned is revenue associated with service provided during the time period. Depreciation is important because when it is covered by revenue, it represents the return of investment to investors. The bottom line or profit/loss on the income statement represents the return on the capital that investors have provided.

In contrast with the private sector approach, governmental organizations focus on budgets, which reflect cash flow, largely ignoring financial return of and return on investments for the owners, who are ultimately the taxpayers. The commercial view of income statements and balance sheets is rare for state agencies, although some SOEs, such as GRUCom that operate commercially, do maintain and report full sets of financial statements. Said another way, a manager in a government agency frequently views tax proceeds as revenue, and not as investment by owners that has to be returned to the owners and on which the owners should receive a financial return. This is not to say that government managers ignore delivering value to taxpayers. Rather, the value is based on mission and not a quantifiable return on investment. As Mark Moore explains, “Public managers create public value. The problem is that they cannot know for sure what it is.”²⁶² This perspective on taxpayer-provided capital was reflected in the comments of two local governmental managers who explained that their insourcing costs are lower than what they would pay to a private entity because, once the taxpayers have paid for the network assets, the only costs the manager need consider are ongoing cash outflows, such as operational and maintenance costs. In contrast, a financially viable privately owned provider has to depreciate assets and provide the owners with a return on the assets.

There are some exceptions to this general financial view of government managers. GRUCom maintains and reports financial statements that are similar to those used in private business.²⁶³ However, even these statements illustrate how governmental entities view taxpayer capital differently than private entities view shareholder capital. GRUCom shows \$50,511,944 in long-term debt in 2009, but only \$25,961,053 in net capital assets for that same time period.²⁶⁴ Such a relationship between long-term debt and long-term assets, namely one where the debt obligations outweigh the assets by nearly 2:1, would not be financially sustainable in a private enterprise.

To create a valid comparison of SOE costs and private-enterprise costs, we calculate SOE annual costs and the sum of each SOE’s operating and maintenance expenses, administrative and general expenses, depreciation, and return on net assets. This is essentially the revenue requirement formula used in public utility regulation.²⁶⁵ Table 13-2 provides the calculations for FLR. In its annual IRS Form 990 filings that we cited earlier, FLR provides values for its net assets in 2007-2009, which we multiply by our estimate of an SOE cost of capital of 3.38 percent. Adding to this the operating expenses and depreciation that FLR reports, we find FLR’s total annual cost to average \$5,221,609. Table 13-2 shows the inputs and derivation of our estimated total cost.

²⁶² Moore, *Creating Public Value*, 57.

²⁶³ Gainesville Regional Utilities, *Annual Report 2008-2009*, 32-64.

²⁶⁴ *Ibid.*, 60-61.

²⁶⁵ Jamison, “Regulation: Rate of Return.”

Table 13-2. Estimate of Florida LambdaRail Cost of Service

<u>Line</u>	<u>Item</u>	<u>2009</u>	<u>2008</u>	<u>2007</u>	<u>Average</u>
1	Revenue	\$ 4,952,940	\$ 5,225,263	\$ 5,318,732	\$ 5,165,645
2					
3	Net Assets	\$ 5,237,643	\$ 5,244,351	\$ 5,080,128	
4	Cost of Capital	<u>3.38%</u>	<u>3.38%</u>	<u>3.38%</u>	
5	Asset Annual Cost (L3 x L4)	\$ 177,032	\$ 177,259	\$ 171,708	
6					
7	Operating Expenditures & Depreciation	<u>\$ 4,962,063</u>	<u>\$ 5,019,823</u>	<u>\$ 5,156,942</u>	
8	Total Cost (L5 + L6)	\$ 5,139,095	\$ 5,197,082	\$ 5,328,650	\$ 5,221,609
9					
10	Net Revenue (L1 - L8)	\$ (186,155)	\$ 28,181	\$ (9,918)	\$ (55,964)

Sources: FLR data are from FLR’s IRS Form 990, years 2007-2009. 5-Year Municipal Bond Rate is from Bloomberg, “Market Data.”

We should note that it is unclear that our cost estimates reflect all of FLR’s costs. As a cooperative arrangement among universities in Florida, it is possible that some of FLR’s work is performed within the individual universities²⁶⁶ and that the costs of this work are not reflected in FLR’s Form 990, which would cause us to underestimate the true cost of FLR’s work.

FLR’s finances as reflected in Table 13-2 further illustrate the difference between how a government entity considers costs and how a private company considers costs. Our estimates, based on how a private business would consider its costs, show negative average net revenue for FLR for 2007-2009. However, in our interviews with FLR, the organization stated its belief that it is commercially viable. We interpret this to mean that FLR is cash-positive and does not consider the cost of money of its owners – who are ultimately the taxpayers of Florida – in considering its total cost.

For MFN and GMAN, we estimate today’s total cost as the approximately \$36 million total revenue that DMS receives from its state clients. This is a reasonable estimate of total cost because it includes the amount that DMS pays to the private operators that supply MFN and GMAN, and it includes DMS’s own costs associated with operations, support, and reselling. In doing this, we remove sales to nonprofits because they are not governmental entities. We also remove sales to local governments because we deal with them separately, as we explain next.

To consider local government costs, we estimate GRUCom’s costs and compare it with services

²⁶⁶ FLR’s bi-annual report for 2008 and 2009 shows photographs of FLR’s Board of Directors and Executive Staff and of its NOC staff. Many of the people in the photos are employed directly by universities. Florida LambdaRail, *Cyber-Infrastructure*, 3 and 15.

provided by MFN to local governments. Table 13-3 provides our cost calculations for GRUCom. In its 2008-2009 Annual Report, GRUCom shows operating, maintenance, administrative, general, depreciation, and amortization expenses of \$8,013,076 and net capital assets of \$25,961,053 for 2009. Applying a cost of capital of 3.38 percent to the net capital asset value and adding to the product the total expenses gives a total annual cost of \$8,890,484. According to GRUCom, 6.79 percent of its services are insourcing for the City of Gainesville, much of which is radio service. Only about 1.14 percent of GRUCom’s revenues come from broadband sold to the City. Applying this percentage to our estimate of GRUCom’s cost of service, we find that GRUCom’s cost for providing broadband to the City of Gainesville is approximately \$101,431 on an annual basis.

Table 13-3. Estimated Costs for GRUCom, 2009

Line	Item	Annual 2009
1	Operating and Maintenance Expense	\$ 2,761,702
2	Administrative and General Expense	\$ 2,104,484
3	Depreciation and Amortization	\$ 3,146,890
4	Total Expenses (L1 + L2 + L3)	\$ 8,013,076
5		
6	Net Capital Assets	\$ 25,961,053
7	5-Year Municipal Bond Rate	3.38%
8	Return on Net Capital Assets (L6 x L7)	\$ 877,484
9		
10	Total Annual Cost All GRUCom Service (L4 + L8)	\$ 8,890,560
11	Total Annual Revenue	\$ 9,203,414
12	Revenue from City for GRUCom	\$ 625,000
13	Ratio of City Payment to GRUCom Revenue (L12 / L11)	6.79%
14	Estimated In-Sourcing Costs All Telecom (L10 x L13)	\$ 603,754
15	Revenue for Broadband from City	\$ 105,000
16	Ratio of City Broadband to GRUCom Revenue (L15 / L11)	1.14%
17	Estimated In-Sourcing Costs for Broadband (L10 x L16)	\$ 101,431

Sources: 5-Year Municipal Bond Rate is from Bloomberg, “Market Data.” Estimates of billing amounts to the City of Gainesville were provided by GRUCom. All other inputs are from Gainesville Regional Utilities, *Annual Report 2008-2009*, 60-62.

As we explain in elsewhere in this report, there is a general trend in local governments to insource broadband, so Gainesville’s costs might be an indicator of what is to come. Based on this, we use Gainesville as a benchmark for local government broadband costs as follows.

According to the U.S. Census Bureau website,²⁶⁷ Gainesville had a population of 110,085 in 2008. Using this as our basis, Gainesville’s broadband costs are about \$0.92 per year per citizen.²⁶⁸ It is likely with the college student population in the city that city services are designed to handle a much larger population, perhaps about 150,000. Using the 150,000 as a basis, our estimate of Gainesville’s broadband costs implies that the city spends about \$0.68 per year per person supported by city services.²⁶⁹

Table 13-4 shows what the costs for local governments would be for broadband if each city and county government in the state incurred the same cost per citizen serviced as does Gainesville. Our high estimate is \$26.3 million and our low estimate is \$19.3 million. By way of a benchmark, the city of Fort Pierce paid about \$78,500 for MFN in 2008-2009, or approximately \$1.84 per population served.²⁷⁰ Fort Pierce also has an insourced broadband network, which would raise its costs for obtaining above the amount it pays for MFN. It is unclear from our investigation why Gainesville’s costs are lower than Fort Pierce’s costs, but the difference could imply that we understate local government broadband expenditures.

We estimate expenditures on broadband for K-12 in two ways. Our high estimate is \$18.9 million, which we calculate as follows. We use the expenditures reported by Florida school districts to the Universal Service Administrative Company (USAC). We exclude expenditures on “Internal Connections” because these are not broadband service. We include all “Internet Access” expenditures as these are likely to be for broadband access. We include all “Telecomm Services” expenditures above \$100,000 per contract because these are likely to include all of the point-to-point broadband connections, although they may include some mobile telecommunications as well. This censoring of the “Telecomm Services” data may cause us to overstate or understate broadband, but we believe that it causes us to overstate the expenditures. This is why we call this our high estimate. We consider broadband expenditures by public and charter schools to be funded 51.3 percent by state budget and 48.7 percent by local taxes, except for what is funded by federal subsidies.²⁷¹ We consider broadband expenditures by private schools to be funded 100 percent by private funds, except for what is funded by federal

²⁶⁷ U.S. Census Bureau, “Population Finder.”

²⁶⁸ Our cost estimates for GRUCom cover only those services used by the city government, not those used by other entities, such as the county government, private entities, or Shands Hospital.

²⁶⁹ In contrast, agencies covered by Ch. 282 spend annually about \$1.95 per population served for MFN services. We do not draw conclusions from this difference in costs because the services provided by local governments and by state governments are very different.

²⁷⁰ According to the U.S. Census Bureau, the city of Fort Pierce had a population of 42,596 in 2009. U.S. Census Bureau, “Population Finder.”

²⁷¹ Total funding for Florida public schools was \$17,333,234,438 in 2010-11. Florida Department of Education, *Florida Education Finance Program*, 1. Local funding provided \$8,444,198,419 or 48.7%. State funding provided \$8,889,036,019, or 51.3%. We omit federal stimulus funding because it is not ongoing funding.

subsidies. Public and charter schools made up about 94 percent (\$17.8 million) of these expenditures by all schools in Florida in 2009 according to USAC, and about 44 percent (\$7.8 million) of their costs were covered by USAC subsidies. Private schools made up the other 6 percent (\$1.1 million) of school broadband expenditures in the state and about 26 percent (\$276,000) of their costs were covered by USAC subsidies.

Table 13-4. Estimate of Projected Broadband Costs for Local Governments in Florida

Line	Item	Amount
1	Gainesville Total Annual Cost of Broadband	\$ 101,431
2	Gainesville Population 2008	110,085
3	Annual Cost per Citizen (L1 / L2)	\$ 0.92
4	Gainesville Population Served by City Services	150,000
5	Annual Cost per Population Served (L1 / L4)	\$ 0.68
6	Florida 2008 Population	18,328,000
7	Florida Percent Urban Population 2000	55.9%
8	Florida Urban Population Estimate 2008 (L6 x L7)	10,245,352
9	Estimated Total Cost for City Government Broadband, High (L3 x L8)	\$ 9,439,917
10	Estimated Total Cost for County Government Broadband, High (L3 x L6)	\$ 16,887,150
11	Estimated Total Cost for Local Government Broadband, High (L9 + L10)	\$ 26,327,067
12	Estimated Total Cost for City Government Broadband, Low (L5 x L8)	\$ 6,927,955
13	Estimated Total Cost for County Government Broadband, Low (L5 x L6)	\$ 12,393,480
14	Estimated Total Cost for Local Government Broadband, Low (L13 + L14)	\$ 19,321,435

Sources: U.S. Census Bureau and authors' estimates.

Our low estimate of K-12 broadband costs is based on DMS's billings for FIRN (Florida Information Resource Network).²⁷² According to DMS, most of the school districts connect to FIRN2 through an aggregation model of local schools to a district point which has one connection to FIRN2. In fiscal year 2008-2009, FIRN provided \$8.3 million of service. After a price decrease due to transition to FIRN2 in fiscal year 2009-2010, these costs decreased to \$4.0 million. DMS staff project FIRN2's revenues at \$6 million in fiscal year 2010-2011. This represents our low estimate for public and charter schools. Using the same ratios as we find in the USAC data, our low estimate for private schools would be \$357,500, with nearly \$93,900 funded by USAC subsidies, and our low estimate of total broadband expenditure for all K-12 in Florida would be \$6.4 million, with about \$2.7 million being paid by USAC subsidies. If DMS is correct that FIRN2 accounts for most of the broadband purchased by public school districts, then

²⁷² See Section 6.2 below for a description of FIRN. There have been two FIRN contracts—FIRN and FIRN2. We strive throughout the report to distinguish between the two contracts when necessary.

our low estimate is more accurate than our high estimate.

13.7 Scenarios

We examine five scenarios for ways in which governmental entities procure and use broadband.

13.7.1 Scenario 1: Present Method of Operation (PMO)

This scenario projects costs for the next five years assuming that the state makes no changes to its current policies and that current demand, price, and technology trends continue.²⁷³

13.7.2 Scenario 2: Leveraging Dark Fiber with Continued Premium Service

The second, third, and fourth scenarios examine increased insourcing of broadband by the state government. In this scenario, the state maintains the service quality provided by today's MFN and leverages existing fiber at less than a market-based price.²⁷⁴

13.7.3 Scenario 3: Leveraging Dark Fiber with Increased Client Service Options

This scenario examines increased insourcing and provisions for state agencies to purchase a service quality that is different from that provided by today's MFN and leverages existing fiber at less than a market-based price.

13.7.4 Scenario 4: Insourcing Market-priced Dark Fiber

This scenario examines increased insourcing with the assumption that the state leverages existing fiber, but at a market-based price.

13.7.5 Scenario 5: Traffic Aggregation

This scenario provides users opportunities to aggregate their connections to the core MFN network, such as might be the case if a regional network were to aggregate traffic. We assume in this scenario that clients continue to obtain CPE from DMS. An important caveat for this scenario is that we assume that current prices for MFN remain unchanged.

We estimate costs under each scenario, but we do not estimate implementation costs. For example, increased outsourcing in scenarios 2-4 would require the government to incur fixed costs for planning and contracting. The service options in Scenario 3 would trigger fixed costs for research to determine viable service options and to develop contract provisions if these options are provided in an outsourcing situation.

²⁷³ These trends are discussed elsewhere in this report.

²⁷⁴ As we explain in more detail elsewhere in this report, the qualities of service provided by MFN, FLR, and others vary. In general MFN represents the highest level of service quality.

13.8 Explanations of Each Scenario's Algorithms

13.8.1 Algorithms for Scenario 1: Present Method of Operation

The model begins with our total cost estimates for MFN/GMAN, FLR, local governments, and schools, including FIRM2. Next, we estimate total costs for years 1 through 5 by applying growth factors. For MFN/GMAN, we use the most recent average growth in MFN/GMAN revenue, but we adjust year 1 revenue to reflect the price decrease given MFN in the contract renewal with AT&T. As Table 13-2 shows, FLR has experienced both a revenue increase and a revenue decline in 2007-2009, so we assume that FLR will experience no growth in years 1-5. We apply the MFN/GMAN growth rates to local governments and schools, but without the price decrease adjustment for year 1.

Next, we separate costs into funding sources. For MFN/GMAN, we allocate 100 percent to the state budget as we explain earlier. For FLR, we average the 2008 and 2009 funding sources to develop an expected allocation. Table 13-5 shows the calculations. For K-12, we assume that 97 percent of the broadband expenditures are for public schools and charter schools, and that the remainder is from private schools.²⁷⁵ Our data appears to capture all of the public schools, but we might miss some charter and private schools causing us to slightly understate expenditures by schools.

²⁷⁵ These percentages are based on the Universal Service Administrative Company, Database.

Table 13-5. Income Sources for FLR, 2008-2009

	2009	2008	Total	Income Source Category	Income Amounts by Category			
					Government			Private
					Federal	State	Local	
<u>Income Statement</u>								
Florida Atlantic	\$ 440,916	\$ 596,724	\$ 1,037,640	State		\$ 1,037,640		
Florida Institute of Technology	\$ 110,850	\$ 148,899	\$ 259,749	Private				\$ 259,749
Florida International University	\$ 382,200	\$ 537,928	\$ 920,128	State		\$ 920,128		
Florida State University	\$ 420,600	\$ 576,408	\$ 997,008	State		\$ 997,008		
Nova Southeastern University	\$ 392,220	\$ 548,028	\$ 940,248	Private				\$ 940,248
University of Central Florida	\$ 401,400	\$ 542,808	\$ 944,208	State		\$ 944,208		
University of Florida	\$ 424,440	\$ 684,317	\$ 1,108,757	State		\$ 1,108,757		
University of Miami	\$ 387,000	\$ 541,528	\$ 928,528	Private				\$ 928,528
University of North Florida	\$ 195,980	\$ 271,844	\$ 467,824	State		\$ 467,824		
University of South Florida	\$ 56,500		\$ 56,500	State		\$ 56,500		
University of West Florida	\$ 208,780	\$ 275,724	\$ 484,504	State		\$ 484,504		
Sum of Primary Members	\$ 3,420,886	\$ 4,724,208	\$ 8,145,094					
Other Members	\$ 1,505,285	\$ 399,098	\$ 1,904,383	Local			\$ 1,904,383	
Total Membership Fees	\$ 4,926,171	\$ 5,123,306	\$ 10,049,477					
Investment Income	\$ 26,769	\$ 101,957	\$ 128,726	Private				\$ 128,726
Total Revenue	\$ 4,952,940	\$ 5,225,263	\$ 10,178,203			\$ 6,016,569	\$ 1,904,383	\$ 2,257,251
				Percent of Total		59%	19%	22%

Source: FLR's IRS Form 990, years 2007-2009.

13.8.2 Algorithms for Scenario 2: Leveraging Dark Fiber with Continued Premium Service

This scenario builds on *Scenario 1: PMO* by adjusting its results to reflect how total costs would change if some portion of the service was insourced. We focus our analysis on the primary outsourced services, MFN and GMAN.

Our first step is to identify the costs that are the same in Scenario 1 and Scenario 2. Using the Total Cost of Broadband and the Growth Factors from Scenario 1, total costs that do not change for Scenario 2 are the product of the total cost in Scenario 1 and the percent of service assumed to not migrate from fully outsourced to dark fiber-based service. More specifically, $TC_{O,-\rho_d} = TC_O \cdot (1 - \rho_d)$, where $TC_{O,-\rho_d}$ is the total cost of service remaining fully outsourced, TC_O is the total cost of service if outsourced as identified in Scenario 1, and ρ_d is the percent of service assumed to migrate from fully outsourced to dark fiber-based. We assume that ρ_d is 10 percent. This is a modest percentage, but it reflects our understanding that MFN operates as a broadband cloud, which makes it technically difficult to insource meaningful portions without significantly changing the MFN contract and technical parameters.

Our next step is to estimate how the other service costs would be different if insourced. We first isolate the costs that will be impacted by insourcing, which are simply the residual $TC_{O,\rho_d} = TC_O - TC_{O,-\rho_d} = TC_O \cdot \rho_d$. We divide this cost into three components: (1) A cost for a network operations center (NOC), $TC_{O,NOC}$; (2) A cost for the network fiber optics unlit, $TC_{O,DF}$; and (3) A cost for lighting the fiber and other conditioning that makes the fiber optics a network capable of providing services, $TC_{O,N}$. While numerous networks have been engineered, built, and used, there exist no standard formulas for separating network costs into these components. Indeed prices for these components are developed on individual case bases and generally kept in private contracts. For our model, we use our expert judgments, supported by our review of information made available for this study,²⁷⁶ to arrive at the following high level cost separation: (1) 50 percent of TC_{O,ρ_d} is for NOC, i.e., $TC_{O,NOC} = 0.5 \cdot TC_{O,\rho_d}$; (2) 20 percent of TC_{O,ρ_d} is for dark fiber, i.e., $TC_{O,DF} = 0.2 \cdot TC_{O,\rho_d}$; and (3) 30 percent of TC_{O,ρ_d} is for lighting, etc., of the fiber optics, i.e., $TC_{O,N} = 0.3 \cdot TC_{O,\rho_d}$. These represent our cost estimates for the outsourced provider. Our next steps adjust these cost components to levels that we would expect for a government provider.

As we explain above, there are several reasons why SOEs have different costs than privately owned operators. The body of research comparing efficiency of SOEs to privately owned

²⁷⁶ For example, according to FLR's 2009 IRS Form 990, its fiber lease was slightly more than 20% of its capital assets in 2008 and 2009.

businesses finds that SOEs are less efficient.²⁷⁷ We make the conservative assumption that this efficiency difference applies to expenses and not to capital.

Regarding taxes, there are some taxes that SOEs would not pay that a privately owned operator would pay, including income taxes and in some instances ad valorem, property, and sales taxes. This advantaged tax treatment could make the SOE appear less expensive than a private operator. However, if service is insourced then the tax burden that the private operator would have born would be shifted to other taxpayers if government budgets remain the same. If governmental budgets shrink by an amount equal to the tax burden that the private operator would have born, then taxes for other taxpayers are unaffected. If we assume that government budgets adjust to the lower taxes, then taxes have essentially no impact on aggregated results because the amount paid by all governments to the private operator includes the relevant portion of all taxes paid by the private operator, but the private operator pays these taxes to the governmental entities. Therefore we include taxes in our cost estimates just as if the SOE were paying all of the taxes the private carriers pay.

We are now ready to express our adjustment factor, A_G , that relates insourcing costs to outsourcing costs. We estimate A_G as $A_G = (1 + \rho_G) \cdot \frac{OPEX_O}{TC_{O,E}} + \frac{DEP_O}{TC_{O,E}} + \frac{TAX_O}{TC_{O,E}} + \frac{RCAP_O}{TC_{O,E}} \cdot \frac{WACC_M}{WACC_O}$, where $OPEX_O$ is the private operator's operating expenses, DEP_O and TAX_O are the private operator's depreciation and tax expenses respectively, $RCAP_O$ is the private operator's return on investment, $TC_{O,E}$ is the private operator's total cost estimated from financial statements, ρ_G is the percentage difference in technical efficiency between a government-owned operator and a privately owned operator, $WACC_O$ is the weighted average cost of capital of a privately owned operator using the Capital Asset Pricing Model, and $WACC_M$ is the representative municipal bond interest rate. Dividing by total cost indexes the components. Omitting income taxes makes the tax adjustment described earlier.

We develop the cost factors in A_G using AT&T as our case for the privately owned operator. This is a reasonable choice because AT&T is the primary provider of MFN/GMAN. Table 13-6 shows how we estimate the expense factors. We do not have cost information for AT&T that is specific to broadband, so we use AT&T's overall wireline costs as our proxy. Using AT&T's 2009 annual report to its shareholders as our database, we first estimate the wireline net investment in property, plant, and equipment. AT&T does not provide an estimate of this amount in its annual report, but it does express its wireline net assets on page 71 of that report. This amount includes current assets and the like that we do not want in our asset measurement, so we factor those out by first removing intangible assets from the company's total assets because the

²⁷⁷ See, for example, Villalonga, "Privatization and Efficiency," 43-74.

intangible assets relate primarily to wireless business as explained in the footnotes of the annual report. We then estimate the ratio of the company’s net property, plant, and equipment to our estimate of the company’s real assets and apply this ratio to the company’s wireline net assets. The result is our estimate of wireline net property, plant, and equipment.

Next, we estimate wireline’s share of taxes by dividing the company’s total taxes by its income before taxes, and then applying that ratio to the wireline income before taxes. We then estimate the company’s total wireline cost by applying our estimate of AT&T’s weighted average cost of capital (WACC), which we provide in Table 13-1, to our estimate of net property, plant, and equipment, and adding that product to the company’s wireline operating expenses, the company’s wireline depreciation and amortization, and our estimate of the wireline taxes. Finally, we estimate our factors by taking ratios of the individual cost elements to total cost, namely $\frac{OPEX_O}{TC_{O,E}} = 0.6528$, $\frac{DEP_O}{TC_{O,E}} = 0.1914$, $\frac{TAX_O}{TC_{O,E}} = 0.0377$, and $\frac{RCAP_O}{TC_{O,E}} = 0.1181$. From the WACC estimates in the body of the paper, we estimate $\frac{WACC_M}{WACC_O} = \frac{3.38}{6.62} = 0.5109$. This makes our adjustment factor $A_G = (1 + \rho_G) \cdot 0.6528 + 0.1914 + 0.0377 + 0.1181 \cdot 0.5109 = (1 + \rho_G) \cdot 0.6528 + 0.2900$.

For this scenario, we estimate the cost of insourced service for Scenario 2, $TC_{G,2}$, as the costs of an insourced NOC plus the costs of insourcing the lighting, etc. of the fiber plus the amount paid for the dark fiber, i.e., $TC_{G,2} = A_G \cdot (TC_{O,NOC} + TC_{O,DF}) + P_{DF,SR}$ or $((1 + \rho_G) \cdot 0.6528 + 0.2900) \cdot 0.80 \cdot TC_{O,\rho_d} + P_{DF,SR}$. We obtain TC_{O,ρ_d} from Scenario 1, so all that mains to explain are the values for ρ_G and $P_{DF,SR}$.

The value of ρ_G is uncertain, but we do have estimates from empirical studies that compare the technical efficiency of SOEs and private firms. The empirical studies we reviewed to obtain values for ρ_G include:

1. Andrews, William A. and Michael J. Dowling. 1998. “Explaining Performance Changes in Newly Privatized Firms,” *Journal of Management Studies* 35(5): 601-617.
2. Ariff, M., Cabanda, E. and M. Sathye. 2009. “Privatization and performance: Evidence from the telecommunications sector,” *Journal of the Operational Research Society* 60: 1315-1321.
3. Bachiller, P. 2009. “Effect of ownership on efficiency in Spanish companies,” *Management Decision* 47(2): 289-307.
4. Bitros, G.C. and E. G. Tsionas. 2004. “A consistent approach to cost efficiency measurement,” *Oxford Journal of Economics and Statistics*, 66(1): 0305-9049.

Table 13-6. Estimate of AT&T’s Broadband Costs

Line	Item	Amount
	Estimation of Wireline Net Property, Plant, and Equipment	
1	Consolidated Assets	\$ 268,752,000,000
2	Consolidated Intangible Assets	\$ 135,082,000,000
3	Estimated Tangible Assets (L1 - L2)	\$ 133,670,000,000
4		
5	Consolidated Net Property, Plant, and Equipment	\$ 100,093,000,000
6	Ratio of Net Property, etc. to Tangible Assets (L5 / L3)	0.7488
7		
8	Wireline Segment Net Assets	\$ 163,028,000,000
9	Estimated Wireline Net Property, etc. (L6 x L8)	\$ 122,076,468,946
10		
	Estimation of Wireline Taxes	
11	Consolidated Taxes	\$ 6,156,000,000
12	Consolidated Income before Taxes	\$ 18,999,000,000
13	Ratio of Taxes to Income before Taxes (L11 / L12)	0.3240
14		
15	Wireline Income before Taxes	\$ 7,949,000,000
16	Estimated Wireline Taxes (L13 x L15)	\$ 2,575,611,559
17		
	Estimation of Wireline Total Cost	
18	Weighted Average Cost of Capital (authors' estimate)	6.62%
19	Estimated Return on Net Property (L9 x L18)	\$ 8,076,083,601
20		
21	Wireline Operating Expenses	\$ 44,646,000,000
22	Wireline Depreciation and Amortization	\$ 13,093,000,000
23		
24	Wireline Total Cost (L16 + L19 + L21 + L22)	\$ 68,390,695,159
25		
	Proportions to Total Cost	
26	Return on Net Property to Total Cost (L19 / L24)	0.1181
27	Wireline Operating Expenses to Total Cost (L21 / L24)	0.6528
28	Wireline Depreciation and Amortization to Total Cost (L22 / L24)	0.1914
29	Wireline Taxes to Total Cost (L16 / L24)	0.0377

Sources: AT&T Inc., *2009 Annual Report*, 59, 60, 71; and authors’ estimates.

5. Cuervo, Alvaro and Belén Villalonga. 2000. “Explaining the Variance in the Performance Effects of Privatization,” *The Academy of Management Review* 25(3): 581-590.
6. Giokas, D.I. and G.C. Pentzaropoulos. 2008. “Efficiency ranking of the OECD member

- states in the area of telecommunications: A composite AHP/DEA study,” *Telecommunications Policy* 32, Issue 9-10, October-November 2008: 672-685.
7. Growitsch, C. Jamasb, T. and M. Pollitt. 2005. “Quality of service, efficiency, and scale in network industries: An analysis of European electricity distribution,” *Applied Economics* 41: 2555-2570.
 8. Gutierrez, Luis H. 2003. “The Effect of Endogenous Regulation on Telecommunications Expansion in Latin America,” *Journal of Regulatory Economics* 23(3): 257-286.
 9. Heinisz, W. and B.A. Zelner. 2001. “The Institutional Environment for Telecommunications Investment,” *Journal of Economics and Management Strategy* 10(1): 123-147.
 10. Kwoka, John E. 1993. “The effects of divestiture, privatization, and competition on productivity in U.S. and U.K. telecommunications,” *Review of Industrial Organization*, 8(1): 49-61.
 11. Kwoka, JE. 2005. “The comparative advantage of public ownership: Evidence from US electricity companies,” *Canadian Journal of Economics* 38: 622-640.
 12. Lien, D. 2001. “Competition and production efficiency – telecommunications in OECD countries,” *Information Economics and Policy* 13(1): 51-76.
 13. Meggison, W.L. and J. M. Netter. 2001. “From state to market: A survey of empirical studies on privatization,” *Journal of Economic Literature* 39(2): 321-389.
 14. Ros, Agustin J. and Aniruddha Banerjee. 2000. “Telecommunications privatization and tariff rebalancing: evidence from Latin America,” *Telecommunications Policy* 24(3): 233-252.
 15. Ros, Agustin J. 1999. “Does Ownership or Competition Matter? The Effects of Telecommunications Reform on Network Expansion and Efficiency,” *Journal of Regulatory Economics* 15(1): 65-92.
 16. Rose, Nancy L., and Paul L. Joskow. 1990. “The Diffusion of New Technologies: Evidence from the Electric Utility Industry,” *The RAND Journal of Economics*, 21(3): 354-373.
 17. Vaaler, Paul M. and Burkhard N. Schrage. 2009. “Residual state ownership, policy stability, and financial performance following strategic decisions by privatizing telecommunications,” *Journal of International Business Studies*, 2009 (40): 621-641.
 18. Villalonga, Belén. 2000. “Privatization and efficiency: differentiating ownership effects from political, organizational, and dynamic effects,” *Journal of Economic Behavior & Organization* 42(1): 43-74.
 19. Wu, Hsueh-liang and David Parker. 2007. “Determinants of Post-Privatization Efficiency Gains: The Taiwanese Experience,” *Economic and Industrial Democracy* 28: 465-493.

Because its value is uncertain, we treat ρ_G as a stochastic variable with a mean of 10 percent with a normal frequency distribution of variance 25 percent.

We do not have examples of what prices for dark fiber that we are confident can be legitimately applied in our scenarios, so we derive estimates of what governments might pay for dark fiber from the data we have on MFN/GMAN and our review of the literature. As we state above, we

estimate that 20 percent of the total cost of an outsourced MFN/GMAN is for fiber, i.e., $TC_{O,DF} = 0.2 \cdot TC_{O,\rho_d}$. This serves as our estimate for the full price of dark fiber that we use in Scenario 4. In Scenarios 2 and 3, we need estimates of the short run price, i.e., a price that would cover the short run variable costs of providing fiber. We choose this price level based on the assumption that a governmental entity that had more fiber than it was using would be willing to make it available to state agencies as long as it was compensated for the incremental cash outflow caused by providing the dark fiber.²⁷⁸

We estimate the incremental cash outflow caused by dark fiber using the Federal Communications Commission's (FCC) recent cost estimates for expanding broadband in the U.S.²⁷⁹ and our cost estimates for GRUCom and AT&T. Exhibit 1-B of the FCC report shows that ongoing capital outlays for broadband were estimated by the agency to be 19.6 percent of the ongoing cash outlays for network operating, support, and general and administrative expenses. From Table 13-3 we find that GRUCom's network operating, support, and general and administrative expenses are about 55 percent of its total cost. From Table 13-6, we estimate that its network operating, support, and general and administrative expenses (including taxes) to be about 69 percent of its total cost. From these numbers, we estimate that the cash outflow caused by providing dark fiber to be between 10.7 percent and 13.5 percent of the total cost of providing full service. For modeling purposes, we use a stochastic variable for the price of dark fiber in scenarios 2 and 3 that has a lower bound of 8 percent of total cost, and upper bound of 16 percent of total cost, and a uniform distribution. Said differently, our expected value for the short run cost of obtaining dark fiber is $E(P_{DF,SR}) = 0.12 \cdot TC_{O,\rho_d}$, that it is stochastic and uniformly distributed between $0.08 \cdot TC_{O,\rho_d}$ and $0.16 \cdot TC_{O,\rho_d}$. Note that $P_{DF,SR}$ is not a unit price, but a total payment for all units of dark fiber purchased in this scenario.

13.8.3 Scenario 3: Leveraging Dark Fiber with Increased Client Service Options

Some aspects of the algorithms for this scenario match those for Scenario 2, namely the use of the total cost base from Scenario 1, the amount of MFN/GMAN that migrates to an insourced mode of delivery ρ_d , the adjustment factor A_G , and the stochastic short run price for dark fiber. What is different in this scenario is that clients who receive service using the insourced network can choose a lower level of service quality than currently offered by MFN/GMAN. Our interviews with government clients revealed some interest in such an option, but the interest was not large so we assume only a modest amount of demand migrates to a lower level of service quality. We let ρ_L represent the proportion of service that is insourced and that customers choose

²⁷⁸ In some instances governmental entities engage in swaps or infrastructure sharing. The short run costs for Scenarios 2 and 3 serve as estimates for the marginal costs of these swaps or sharing in instances where the arrangements do not result in additional investment.

²⁷⁹ Federal Communications Commission, *Broadband Availability Gap*. The calculation is $\$2.8 \text{ billion ongoing capex} / (\$11.8 \text{ billion ongoing network opex} + \$2.5 \text{ billion ongoing general and administrative}) = 19.6\%$.

to have provided at the lower quality and assume that it is about half of the service, i.e., $\rho_L = 0.50$.

The lower service quality has two impacts. The first impact is that it lowers the cost of the insourced service. We cannot say how much this lower quality decreases value for the state clients, but since these customers always have the option of staying with the existing MFN/GMAN quality, we assume that they migrate to a lower quality only if the cost difference more than compensates them for the value loss. Of course, this freedom to make trade-offs between cost and value could be allowed with a different outsourcing contract than currently exists. So while we demonstrate this option in the context of insourcing, if policymakers believe that service quality options are of value, they could implement this in an outsourcing framework.

The cost impact of lower service quality depends on the quality choices made. We do not know what choices clients might make, so we illustrate the impact by assuming that the cost savings are about 25 percent of the insourcing costs, i.e., $\rho_{C,L} = 0.25$.

The second impact of allowing a lower service quality is that the state broadband provider could have difficulty collecting some monies from its customers. A situation we heard about during our interviews went something like this: The government broadband provider offers clients two service qualities, A and B, where quality B provides customers with a lower guarantee of service availability. For example, service level A might assure customers that if there is a network outage, service will be restored in 2 hours, but service level B only assures that service will be restored in 24 hours. Some customers choose service level B because it has a lower price than service level A. But when an outage occurs, some B customers demand that their service be restored within the 2-hour window promised to purchasers of service level A. When the state broadband provider points out to the B customers that they did not pay for that level of service, these customers might agree to pay the higher price *ex post* or they might rally political supporters to intervene on their behalf and pressure the service provider to restore service within the 2-hour window. Even if these B customers agree to pay the higher fees in order to have service restored quickly, they might then behave opportunistically and renege on the agreement, perhaps with the backing of their political supporters. We allow for this possible collection problem in our modeling, but it impacts who covers the insourcing costs and not the overall insourcing costs, so it has no impact on our modeling outputs.

We are now ready to express the costs for Scenario 3. All costs are the same as with Scenario 2, except for the costs of insourcing. Insourcing costs for this scenario are $TC_{G,3} = TC_{G,2} \cdot (\rho_L \cdot (\rho_{CL} - 1) + 1)$.

13.8.4 Scenario 4: Insourcing Market-priced Dark Fiber

The algorithms for this scenario are the same as Scenario 2, except that we use $TC_{O,DF} = 0.2 \cdot TC_{O,\rho_d}$ as our price of dark fiber rather than $P_{DF,SR}$.

13.8.5 Scenario 5: Traffic Aggregation

This scenario analyzes the potential cost impact of customers aggregating traffic into a shared port. We assume that the proportion of customers ρ_S who choose to share a port is 10 percent, i.e., $\rho_S = 0.10$.

The cost impact for customers in sharing a port is two-fold. First, the customers move from individual ports to a larger, shared port. The second impact is that they could use an alternative access provider.

We identify the potential cost impacts of sharing a port using standard engineering analysis of traffic queuing and existing MFN price relationships. We assume that the agencies are currently served by T1 lines,²⁸⁰ but that the agencies vary in their actual utilization of the lines. For some, a T1 line is larger than what they actually need. For the agency with the largest data demand, we assume a T1 is optimal. For the agency with the smallest data demand, we assume half a T1 would be optimal. We assume that agencies are uniformly distributed on a continuum from smallest demand to largest demand where the location on the continuum represents the agency's data demand. We also assume that agencies prefer the same average wait time for data delays and that the wait time is *de minimis*.

Using standard M1 model for traffic,²⁸¹ the optimal wait time for the largest data user is $W = \frac{h_H - T1}{h_H}$, where W is the average wait time that is identical for all users, h_H is the data usage (more precisely, the average arrival rate of data) for the largest user, and $T1$ is the capacity of a T1 line, namely 1.5 Mbps. Solving for h_H , we find that the largest user's usage is $h_H = \frac{T1}{1-W}$. Similarly, we find that the smallest user's usage is $h_L = \frac{T1}{2(1-W)}$. The average user's usage is the midpoint between the highest and lowest, or $\frac{h_H + h_L}{2}$, making the total data usage for the customers sharing a port to be $n_R \frac{h_H + h_L}{2} = n_R \frac{\frac{T1}{1-W} + \frac{T1}{2(1-W)}}{2} = n_R \frac{3T1}{4(1-W)}$, where n_R is the number of customers.

Assuming that wait time is *de minimis* and that the customers choosing to be served through the sharing process are randomly distributed by usage, we can now express the optimal MFN port size for the sharing users as $k = n_R \frac{3T1}{4}$, where k is the optimal capacity. Normalizing the number of MFN choosing this option to 10 per sharing arrangement and numerically representing the capacity of a T1, we calculate the shared port capacity to be $k = 10 \cdot \frac{3 \cdot 1.5}{4} = 11.25$, which we round to 12 Mbps.

²⁸⁰ A T1 line is a telecommunications line that transmits data at 1.544 Mbps.

²⁸¹ Gross and Harris, *Fundamentals of Queuing Theory*, 53-68.

From the MFN price list, it appears that the monthly recurring port charges for a T1 port are about 1/5th the corresponding charges for a 12 Mbps port. This means that these customers would save about 50 percent on their port charges if they were able to share, assuming that the MFN price list did not change. Based on a review of MFN billing data, we assume that the proportion ρ_P of MFN revenue from ports is about half of all MFN revenue, i.e., $\rho_P = 0.50$.

Also in this scenario, we assume that customers might choose an alternative access provider, such as a regional network or a local governmental entity. We do not know how these enterprises' access prices might compare to the existing MFN access prices. However, we did observe in our interviews that at least some of these alternative providers have significant political support and claim that, if they are financially viable, that they will create jobs and spur economic development. We conclude from these observations that there is some possibility that the alternative access providers might have higher access prices than the existing MFN providers and that there would be pressure on governmental customers to pay the higher prices in the name of subsidizing job creation and economic development. On the other hand, the alternative networks might have excess capacity and would be willing to provide access prices at a discount to the existing MFN providers. Given this, we assume that the alternative carriers' access prices could be 10 percent greater than the existing MFN access prices, or at a level comparable to the price levels found in Scenario 2 assuming facilities are provided at short run incremental cost, or somewhere in between. More specifically we assume that the alternative access price $P_{A,A}$ is a stochastic variable that is uniformly distributed between its upper bound that is 10 percent higher than the prevailing MFN access price $P_{O,A}$ and its lower bound that is $\frac{TC_{G,2}}{TC_{O,\rho_d}} \cdot P_{O,A}$.

Based on a review of MFN billing data, we assume that the proportion ρ_A of MFN revenue from access is approximately 30 percent of all MFN revenue, i.e., $\rho_A = 0.30$.

13.9 Modeling Results

13.9.1 Summary of Findings

Our modeling results show no compelling reason to change the current insourcing and outsourcing models used by the governments in Florida. With respect to state agencies, we find that there could be some budget savings from insourcing if network facilities such as dark fiber could be obtained at less than a fully compensatory market price, such as making use of underutilized network facilities of local governments or FDOT, if there are such underutilized facilities. However, for the budget savings to occur, the price discounts would need to more than compensate for the loss of technical efficiency that would be expected when a governmental entity engages in production activities normally outsourced to private businesses. If the insourcing requires the construction of network facilities at a normal cost level or requires leasing such facilities at market prices, then the budget savings would largely disappear according to our calculations.

Even if there were potential budget savings from insourcing by using network facilities without paying market prices, such insourcing may not be more economical than outsourcing. The potential budget savings comes from the lower price for network facilities such as dark fiber and from being able to use taxpayer capital without compensation for opportunity costs. If taxpayers were compensated for their opportunity costs of capital at a normal market rate after allowing for depreciation of assets, then arguably the capital costs for the governmental entity would be the same as for a private operator and the budget savings are not true cost savings from the taxpayer perspective.

Perhaps the most promising source of budget savings comes from giving clients options for the quality of services and features that they purchase. Presumably if such options were provided, agency chief information officers would work with their internal users to determine which service options are most beneficial to the mission of the organization, just as they do today for purchasing other information services and for deciding the amount of broadband to purchase. If these chief information officers find that their organizations could save on their budgets by purchasing a different set of features and quality than are offered with today's MFN, then the state could save on its overall budget or divert budget resources to places where they would be more effective, either within that same agency or to other agencies. In our modeling, these budget savings result in part from the free use of taxpayer capital as discussed above, but most of the savings we find are true cost savings because they result from clients optimizing their own budgets.

Another possible source of budget savings is in the sharing of access to and ports into the MFN core network. We find that there would be expected cost savings by sharing of ports as long as the potential savings are not lost in a rebalancing of port prices that could be triggered by the new sharing options. We are uncertain that there would be cost savings in sharing of access if there was a new access provider that was given preferential treatment by governmental entities. Research has found that when the government plays a role as business developer or business owner, the government often gives the operator preferential treatment in competitive situations, which can lead to higher prices for customers.²⁸² Because state, local, and federal governments have been involved in the development and financing of some potential access aggregators in Florida, our financial modeling recognizes that access cost savings may not be forthcoming.

We describe our findings in more detail next.

13.9.2 State Agencies

Table 13-7 and Figure 13-1 present our modeling results for state users covered by Chapter 282, namely those clients that are required to use MFN. The columns in Table 13-7 represent

²⁸² See for example Edwards and Waverman, "Effects of Public Ownership," 23-67.

scenarios, which we designate as described above. The first row of numbers contains the mean five-year cost for each scenario. The bottom two rows represent a 90 percent interval, meaning that 90 percent of our estimates fell between the high and low numbers shown in the columns.

Table 13-7. Five-year State Agency Costs by Scenario

		Five-year Total Cost for State Agencies				
		Scenario 1: PMO	Scenario 2: Surplus Dark Fiber, Premium	Scenario 3: Surplus Dark Fiber, Options	Scenario 4: Market- Based Dark Fiber	Scenario 5: Aggregation
Mean		\$186,499,637	\$185,145,306	\$178,659,444	\$186,620,926	\$184,837,845
90- percent Interval	High	\$196,149,376	\$194,801,903	\$187,977,777	\$196,314,412	\$196,333,333
	Low	\$177,116,553	\$175,817,477	\$169,662,604	\$177,200,537	\$174,133,914

Figure 13-1 plots the data from Table 13-7 in a high-low-mean format. Each vertical bar represents a scenario, with the top of the bar representing the highest estimate in the 90 percent interval, the bottom of the bar representing the lowest estimate in that interval, and the cross hash representing the mean. This chart shows that *Scenario 3: Leveraging Dark Fiber with Increased Client Service Options* offers the greatest potential for budget savings. This budget savings results from securing network facilities at below market prices (because of underutilized capacity), not compensating taxpayers for financing investment, and agency chief information officers choosing more economical levels of service and network features than are currently provided by MFN. Most of the savings result from the chief information officers' exercising their purchasing options, so the savings would not occur if all agencies actually prefer the MFN service quality.

The delivery model represented by *Scenario 4: Insourcing Market-priced Dark Fiber* would not be expected to result in a budget savings according to our calculations. While using taxpayer monies to make investments would provide some budget savings relative to outsourcing, those budget savings are more than taken up by the probable loss in technical efficiency.

The chart also shows that the delivery model, represented by *Scenario 5: Traffic Aggregation*, could result in higher budget costs - if access costs are higher - or budget savings, if access costs are lower, indicating that the results of aggregation depend in part on the change in access costs. More specifically, higher access costs could wipe out any cost savings from sharing ports, but lower access costs enlarge the cost savings that could result from port sharing.

Figure 13-1. Scenario Modeling Results for State Agencies

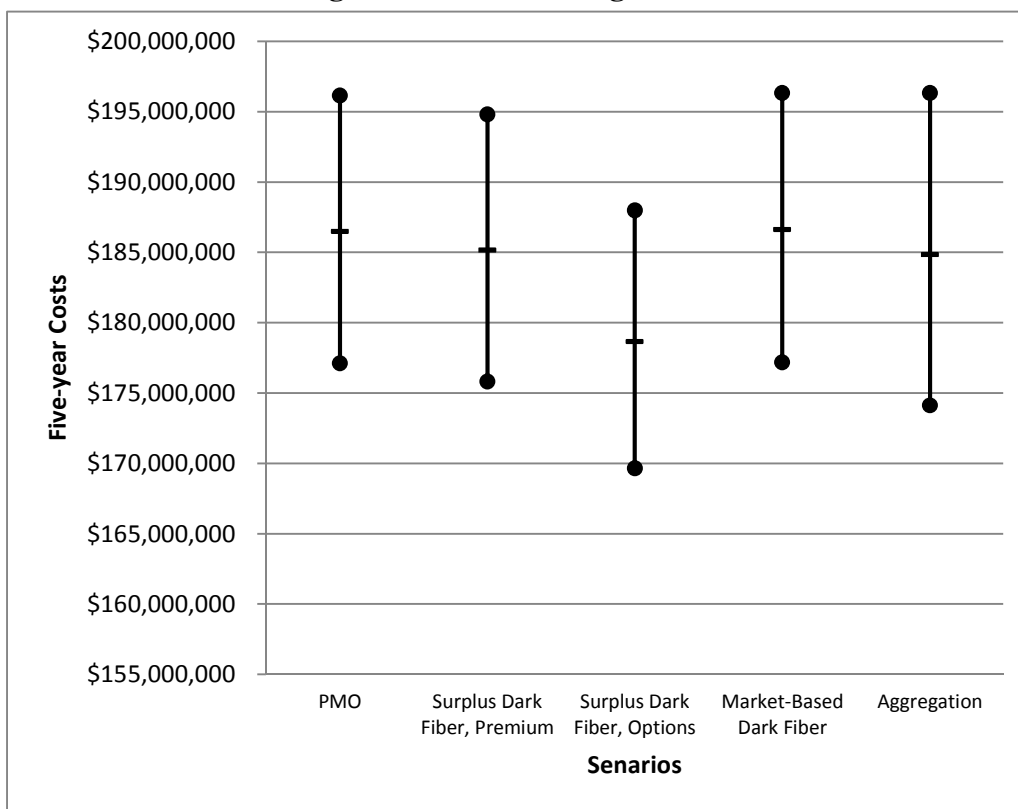

In general the budget impacts we estimate are not large, generally in the 1 percent to 5 percent range. This is in part because we are conservative in our approach. We assumed marginal changes in outsourcing of MFN because of the complexity of replacing portions of that network service. We also assumed marginal changes in the number of customers who would choose a lower level of service quality because, in general, the state agencies expressed satisfaction with the current MFN. Larger changes in outsourcing or customer adoption of lower service qualities would have larger impacts, but they would also cause the state to incur fixed costs for planning, development, and service rearrangements. Also, we purposefully underestimated the potential loss in technical efficiency from insourcing by applying the efficiency parameters only to operating expenses when in reality the research upon which these parameters was based applied to capital costs as well as the budget savings that result from using taxpayer capital.

13.9.3 Education

We rely upon FLR and MFN for broadband cost information for Florida colleges and universities. This omits college and university broadband expenditures for self-supply and for purchases from other broadband providers.

Table 13-2 shows our estimate of FLR’s annual total cost of \$5,221,609. We project FLR’s five-year costs to be about \$26,500,000. Our 90 percent interval ranges from \$23,799,912 to \$27,448,992.

Some colleges purchase broadband from MFN. Table 13-8 and Figure 13-2 show our estimates of these five-year expenditures under our five scenarios. As would be expected, these results follow the same pattern as the state agencies, namely that there is an expected budget savings for insourcing if network facilities are obtained at less than market price (Scenarios 2 and 3), a higher cost for insourcing than for the PMO if market prices are paid for network facilities (Scenario 4), and a possible cost savings from aggregating access and ports (Scenario 5). The largest potential budget savings comes from providing options for service quality. In contrast to the case of state agencies where we were uncertain that customers might purchase lower quality than the current MFN, it seems likely that colleges would take advantage of a lower quality service because FLR, which is owned by and serves the major universities in Florida, offers only a lower quality service,²⁸³ indicating that the universities prefer that service level.

As shown above, we estimate expenditures on broadband for K-12 for public and charter schools to be between \$6 million and \$17.8 million annually. The lower number omits all broadband purchased by schools from sources other than FIRN2 and the higher number includes some non-broadband expenditures.

13.9.4 Local Governments

If Gainesville is indicative of local governments’ expenditures for broadband, then the \$19.3 million to \$26.3 million shown in Table 13-4 is a reasonable estimate of annual costs for city and county governments for broadband. Using this as our basis, we would expect a total five-year cost of \$140 million with our high estimate, or \$103 million with our low estimate. The range for our 90 percent interval is plus or minus 7 percent.

²⁸³ We use the term service quality in our scenarios to represent any service parameter, including service level agreements.

Table 13-8. Five-year MFN College Costs by Scenario

		Five-year Total Cost				
		Scenario 1: PMO	Scenario 2: Surplus Dark Fiber, Premium	Scenario 3: Surplus Dark Fiber, Options	Scenario 4: Market-Based Dark Fiber	Scenario 5: Aggregation
Mean		\$2,436,243	\$2,418,555	\$2,333,829	\$2,437,830	\$2,414,544
90- percent Interval	High	\$2,609,695	\$2,595,275	\$2,502,266	\$2,613,340	\$2,610,212
	Low	\$2,269,274	\$2,250,519	\$2,172,761	\$2,269,103	\$2,228,942

Figure 13-2. Scenario Modeling Results for MFN Sales to Colleges and Universities

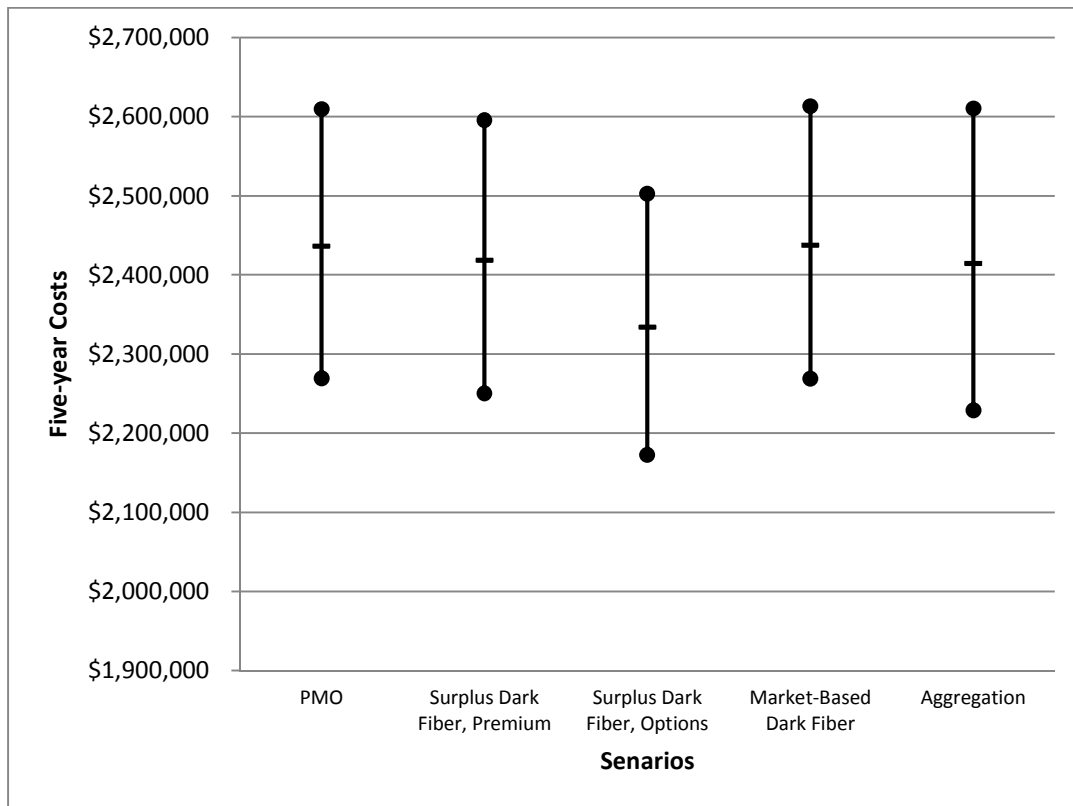

14 Statewide Florida Broadband Networks and Services for Government Use

Next, we provide a more detailed context for our policy recommendations regarding governance and cost performance monitoring in Volume 1.

14.1 Florida Law

In this section, we describe Florida’s legal framework for planning and implementation of its enterprise network and the technical characteristics of three networks serving Florida anchor institutions. Our discussion also draws upon the insights from our analysis comparing Florida to other states. We provide a summary of the laws governing SUNCOM and later in this report, in the context of governance, we summarize the statutes governing Agency for Enterprise Information Technology (AEIT).

14.2 Florida Communication Information Technology Services Act ²⁸⁴

The Communication Information Technology Services Act establishes the SUNCOM Network,²⁸⁵ defines the responsibilities of the DMS²⁸⁶ relative to SUNCOM, and designates public and private entities that may use SUNCOM. In addition, the Act defines the DMS’s responsibilities for the State Agency Law Enforcement Radio System (SLERS), mutual aid channels, interoperability network and statewide regional law enforcement communications system. SUNCOM was established in Florida Statutes in 1975, and SLERS began with the Joint Task Force in the late 1980s.²⁸⁷

²⁸⁴ Questions about interpretation or applicability of these or other provisions of Florida law should be directed to competent legal counsel. The Act is codified at sections 282.701 – 282.711, Florida Statutes. Statutes cited were accessed at <http://www.leg.state.fl.us/statutes/>. Session laws cited were accessed at <http://laws.flrules.org/>. Note that definitions used in the Act are codified at Section 282.0041(1) Florida Statutes.

²⁸⁵ SUNCOM as described on the DMS website is not a “network” but a portfolio of telecommunications services. Among the services provided by DMS under SUNCOM is a data transport service called MFN. Service elements that comprise MFN include network core, local loop access, customer premises equipment, security, network management tools, design and engineering, among others. MFN is described in detail in this report. See Department of Management Services, “SUNCOM Products and Pricing.”

²⁸⁶ DMS is created as a department of the Executive Branch of Florida state government by Section 20.22, Florida Statutes. The authorizing statute establishes the Secretary of Management Services as the head of DMS. The Secretary is appointed by the Governor, subject to confirmation by the Senate, and serves at the pleasure of the Governor. Statutory programs of DMS include: Facilities, Technology, Workforce, Support, Federal Property Assistance and Administration. Statutory Divisions include Administrative Hearings, Retirement, and State Group Insurance. The section creating the Department and establishing its programs and divisions was last amended by s. 2, ch. 2007-105, Laws of Florida.

²⁸⁷ Department of Management Services, *Division of Telecommunications Business Model*, 8, 38.

The SUNCOM Network is established “as the state enterprise telecommunications²⁸⁸ system for providing local and long-distance communications services to state agencies,²⁸⁹ political subdivisions of the state, municipalities, and nonprofit corporations . . .”²⁹⁰ SUNCOM must be able to transmit all types of telecommunications signals. State agencies are required by the Act to cooperate and assist in development and use of telecommunications systems and services.

14.2.1 DMS Powers and Duties

The Act creates powers, duties, and functions of the DMS regarding the SUNCOM Network.²⁹¹ DMS must “design, engineer, implement manage, and operate through state ownership, commercial leasing, contracted services, or some combination thereof, the facilities, equipment, and contracts providing SUNCOM Network services, and . . . develop a system of equitable billings and charges for telecommunications services.”²⁹² Related powers and duties in summary form include:

- Publishing electronically the portfolio of services available from DMS including pricing, policies governing usage, and DMS’s priorities for each telecommunications service;
- Adopting technical standards for the state telecommunications network;
- Entering into agreements related to IT²⁹³ and telecommunications services with state agencies and political subdivision of the state;
- Applying for, receiving and holding authorizations, patents, copyrights, trademarks, service marks, licenses, and allocations of channels and frequencies to implement the Act;
- Acquiring and holding, or disposing of real, personal, and intellectual property;
- Cooperating with federal, state, or local emergency management agencies to provide emergency telecommunications services;

²⁸⁸ "Telecommunications" is defined to mean "the science and technology of communication at a distance, including electronic systems used in the transmission or reception of information." Section 282.0041(26), Florida Statutes.

²⁸⁹ "Agency" is defined to mean "any official, officer, commission, board, authority, council, committee, or department of the executive branch of state government. . . ." Section 216.011(1)(qq), Florida Statutes. The definition does not encompass the Legislative and Judicial Branches. For purposes of Chapter 282, the definition also excludes university boards of trustees and state universities. Section 282.0041(1) Florida Statutes.

²⁹⁰ Section 282.703(1), Florida Statutes.

²⁹¹ Florida Statutes Section 282.702

²⁹² Section 282.703(2), Florida Statutes.

²⁹³ "Information technology" is defined to mean "equipment, hardware, software, firmware, programs, systems, networks, infrastructure, media, and related material used to automatically, electronically and wirelessly collect, receive, access, transmit, display, store, record, retrieve, analyze, evaluate, process, classify, manipulate, manage, assimilate, control, communicate, exchange, convert, converge, interface, switch, or disseminate information of any kind or form." Section 282.0041(16), Florida Statutes.

- Controlling and approving the purchase, lease, or acquisition and use of telecommunications services, software circuits and equipment provided as part of any other total telecommunications system to be used by the state or its agencies;
- Adopting rules and regulations relating to telecommunications and to administering the provisions of the Act;
- Applying for and accepting federal funds, gifts and donations for the purposes of the Act;
- Monitoring relevant issues before the Florida Public Service Commission and the FCC and, if necessary, providing testimony or information in proceedings before the commissions;
- Managing and controlling (unless delegated to the agencies), but not intercepting or interpreting, telecommunications within the SUNCOM Network;
- Planning, designing, and conducting experiments for telecommunications services, equipment, and technologies, and implementing enhancements in the state telecommunications network if in the public interest and cost-effective. Funding for any experiments must be derived from SUNCOM Network service revenues and may not exceed two percent of the annual budget for the network for any fiscal year or as provided in the General Appropriations Act. New services offered as a result of the experiments cannot affect existing rates for facilities or services.
- Entering into contracts or agreements to make DMS's property available for the placement of facilities by any wireless provider of mobile service and any telecommunications company. DMS may charge fees for the placement of the facilities.²⁹⁴
- Establishing policies that ensure that DMS's cost-recovery mechanisms and accounting data are captured and reported in compliance with all applicable federal and state laws and rules. DMS is required to annually submit to the Governor, the President of the Senate, and the Speaker of the House a report that describes each service and its cost, the method for recovering the cost, and, if applicable, the identity of any services that are subsidized.

14.2.2 Exemptions from the Required Use SUNCOM Network²⁹⁵

All Executive Branch agencies, except state universities²⁹⁶ and FDOT (for traffic control and

²⁹⁴ Section 282.702(14) contains conditions and specifications that have not been repeated in this summary.

²⁹⁵ Florida Statutes Section 282.703.

²⁹⁶ Prior to the 2002 amendment of the Act, state universities were not explicitly included as participants in the SUNCOM Network, nor required to use SUNCOM services. However, they appear to have been subsumed under the definition of "state agency" in Section 216.011, Florida Statutes, as part of the Executive Branch. State universities were explicitly added to the requirement to use SUNCOM by Chapter 2002-387, Laws of Florida. The most recent amendment of the Act by the 2010 Legislature (Chapter 2010-148, Laws of Florida) repealed the

surveillance only),²⁹⁷ must use the Network; “however, an agency is not relieved of responsibility for maintaining telecommunications services necessary for effective management of its programs and functions.”²⁹⁸ If an agency determines that a Network service does not meet its needs, the agency is required to notify DMS in writing and describe its service requirements. If DMS cannot meet an agency's requirements, it may grant the agency an exemption from use of the Network. Unless DMS has granted an exemption, all customers of a state primary data center,²⁹⁹ except state universities, must use the Network services connecting the primary data center “to SUNCOM services for all telecommunications needs in accordance with department rules.”³⁰⁰ When DMS learns that a primary data center customer that has not been granted an exemption is not on the Network, DMS is required to provide the customer with a schedule and a cost-estimate for transferring to the Network. The primary data centers and their customers are required to cooperate with DMS to complete the transfer. Other than the case-by-case exemption procedure, state universities are the only class of state agencies whose use of SUNCOM is discretionary.

14.2.3 Use of State SUNCOM Network by Municipalities³⁰¹

Any municipality may request from DMS any or all of the Network’s services, on terms established by DMS. The requesting municipality is required to pay “its share of installation and recurring costs according to the published rates . . . and as invoiced by the department.”³⁰² In addition, the requesting municipality is required to pay any charges that apply to requested modifications to the existing SUNCOM Network services. It appears that DMS has discretion over the terms and conditions under which it provides services to municipalities.

14.2.4 Use of State SUNCOM Network by Nonprofit Corporations³⁰³

DMS must provide a means by which certain private nonprofit corporations may use the SUNCOM Network. An eligible nonprofit corporation must spend the majority of its direct revenue to provide contractual services to the state, a municipality or a political subdivision; and

requirement that universities and university libraries use the SUNCOM network. The Department is authorized to provide services to a state university if requested to do so by a university.

²⁹⁷ Section 335.14(2), Florida Statutes: "Computerized traffic systems and control devices which are used solely for the purpose of motor vehicle traffic control and surveillance shall be exempted from the provisions of chapter 282."

²⁹⁸ Section 282.703(5), Florida Statutes.

²⁹⁹ "Primary data center" is defined to mean "a state or non-state agency data center that is a recipient entity for consolidation of non-primary data centers and computing facilities. A primary data center may be authorized in law or designated by the Agency for Enterprise Information Technology pursuant to s. 282.201." Section 282.0041(19), Florida Statutes.

³⁰⁰ Section 282.703(5)(b), Florida Statutes.

³⁰¹ Florida Statutes Section 282.704.

³⁰² Ibid.

³⁰³ Florida Statutes Section 282.705.

receive only a small portion of its total revenue from any other source during the time SUNCOM Network services are requested. Nonprofit corporations established by law and an association of municipal governments that is wholly owned by the municipalities are also eligible to use the SUNCOM Network. Private, nonprofit, elementary and secondary schools that have an endowment of \$50 million or less are eligible for rates and services on the same basis as public schools.

14.2.5 Use of SUNCOM Network by Libraries³⁰⁴

DMS may provide SUNCOM Network services to any library in the state. The statute specifically states that it is not to be interpreted to require a state university library to use SUNCOM Network services.

14.3 The MyFloridaNet (MFN)³⁰⁵

SUNCOM as provided by the DivTel is a portfolio of voice, data, video and other technology products and services. SUNCOM voice services include local telephone service (primarily through Centrex), long distance service, toll free/800 service, and mobile wireless service. The centerpiece of SUNCOM data services is MFN. Other data services include Virtual Private Networking, Metropolitan Area Networking, Remote Broadband Service, FIRN2, and mobile wireless data service. Additional SUNCOM services include STEPS (SUNCOM Telecommunications equipment on-premise Service), conferencing services (voice, video and web), and installation and project management for infrastructure.

MFN is a Multi-Protocol Label Switching (MPLS) capable Internet Protocol (IP) network, which has a scalable statewide footprint. MFN “provid[es] improved security and robust connectivity resulting in a highly available (HA) and highly reliable (HR) statewide communication network.”³⁰⁶ “The MyFloridaNet network platform provides a very flexible, highly available and secure communications infrastructure especially designed to satisfy the growing demands of our customers’ high availability, multimedia capable and security sensitive applications.”³⁰⁷ MFN is procured under contract from AT&T as the prime contractor. AT&T has subcontracts for particular functions (e.g., Network Operations Center from CenturyLink) and geographical areas (e.g., other provider territories including CenturyLink and Verizon).³⁰⁸

³⁰⁴ Florida Statutes Section 282.706.

³⁰⁵ Review of this section was requested January 14, 2011 and timely received from Danny Thomas of AT&T and management of DMS in time for final publication of this report. We appreciate and acknowledge the review of this section provided by AT&T and DMS.

³⁰⁶ Department of Management Services, “MyFloridaNet.”

³⁰⁷ Department of Management Services, “MyFloridaNet.” For a full list of MFN features, see Ghini, *Renewal versus Rebid of the MyFloridaNet Contract*, Attachment 9.

³⁰⁸ As described below, the MFN contract was extended for an additional five years by amendment dated December

MFN provides a layer of security as a separate government IP network, as well as providing customer tools for monitoring security and performance. The connectivity and support for applications that MFN provides is illustrated by the following:

MFN provides services to more than 150,000 users. Its core users are the State of Florida agencies, but it also provides services to various counties, cities, municipalities, and non-profits. MFN delivers - in addition to typical network computing tasks (e.g. browsing the Internet, reading e-mail, file sharing) - statewide connectivity to crucial enterprise applications as well as facilitating public access to all state services. Examples include: FLAIR, Florida Crime Information Center, Florida Driver License Information System, Home SafeNet, and Florida Unemployment Internet Claims.³⁰⁹

Additional critical applications³¹⁰ supported by MFN are listed in Appendix IV and the impact of downtime on an agency can also be considered by reference to Appendix IV below, which shows “exceeded downtime impact” from Technology Review Workgroup (TRW) reporting.

We note from review of MFN billing summary data that currently approximately 75 percent of MFN connections are at the T-1 level (1.544Mbps) or less, and most of these connections are frame relay as opposed to Ethernet. This raises the general question: Are the agencies’ service purchases “all they need,” “all they can afford,” or “all that is available”? As might be expected given the variety of agencies, the answer to this question is mixed.³¹¹ Some, but not all agency choices appear to be influenced by cost.

14.3.1 Funding of MFN

MFN is funded by payments from individual agencies that use MFN services. State of Florida executive branch agencies must obtain telecommunications services from DMS; and other government entities, universities, libraries and non-profit organizations may obtain such services from DMS. MFN provides service elements such as network core, local loop access, CPE,

28, 2010.

³⁰⁹ Ghini, *Renewal versus Rebid of the MyFloridaNet Contract*, 1.

³¹⁰ *Ibid.*, Attachment 14. Attachment 14 contains a list of additional critical applications that run on MFN that is reproduced in Appendix IV.

³¹¹ Furthermore answers are difficult to interpret because the questions and answers are fraught with equivocations. The question of need begs the question, “For what purpose?” Different people can answer that question differently, which makes comparisons of their answers to the need question invalid. The question of affordability is less problematic because it highlights tradeoffs. For example, one manager might find broadband affordable if she finds it is less costly than, for example, publishing and distributing hard copies of documents, or traveling for meetings, and the like. Another might find broadband unaffordable use of broadband service does not improve overall efficiency or effectiveness for his organization. These tradeoffs highlight the effectiveness of broadband relative to other budget options.

Internet access, security, network management tools, design and engineering for a complete turn-key data network solution with banded flat-rate pricing statewide. Included engineering services are security engineering and dedicated AT&T engineers to assist in trouble-shooting problems. No contract is required except for the initial 12 months for the Metropolitan Area Network (MAN) 2, 3, and 4 services contained in the MFN contract extension. These services move to month-to-month after one year.

There are two elements to MFN network pricing—port and local loop access. The MFN core port for all local loop access types is a flat monthly rate, with the rate depending on speed/bandwidth. Under the new MFN extension agreement³¹², local loop access is flat monthly rate with published rates for all bandwidths up through 1Gbps, statewide as follows:

- 56kbps to 12Mbps – Flat Rate
- 15Mbps to 45 Mbps – Flat rate within 25 miles
- 90Mbps to 1000Mbps – Flat rate within 10 miles (Metro Ethernet)

There is no cost of installation for MFN elements (Port, Access and CPE), and billing is month-to-month, with no term.

14.3.2 MFN Features and Benefits

According to DMS’s web site, MFN’s features and benefits are as follows:³¹³

FEATURES	BENEFITS
End to End Quality of Service	MFN’s sophisticated Quality of Service capabilities allow classification of your data, prioritizing voice, video and mission critical data more efficiently.
Web Based Network Management	Check the health of your network from anywhere, anytime, using sophisticated Network Management System tools.
Service Level Agreements (SLA)	A four-hour problem-resolution SLA is a standard feature of MFN and ensures customer troubles are addressed in a mission critical fashion.
Integrated Security	MFN enterprise security solution includes professionally managed and maintained advanced security appliances capable of integrating a wide variety of network aware devices in order to better safeguard the enterprise.

³¹² Amendment 5 to MyFloridaNet Contract, 2, 3, and 4.

³¹³ Department of Management Services, “MyFloridaNet.”

The high reliability and high availability of MFN is backed up by a strict Service Level Agreement (SLA).³¹⁴ The SLA includes service restoral to the individual customer in the stated window, rather than being based on averages. The approach to integrated security includes dedicated security engineers, with the MFN Contract Extension adding one additional dedicated security engineer.³¹⁵

14.3.3 MFN Before and After the Contract Extension

Figure 14-1 shows the MFN prior to the recent MFN contract extension, including location of the ten Core Nodes, as well as Internet connectivity provided through MFN via three separate Internet Service Providers. The MFN Core Nodes depicted in the 10 cities in the Figure 14-1 corresponds to the 10 Local Access and Transport Areas and Market Areas into which Florida is divided.

Figure 14-2 shows the MFN which results from the recent MFN extension with a single Internet Service Provider, including location of the 10 Core Nodes. The MFN Core Nodes depicted in the 10 cities in the figure below corresponds to the 10 Local Access and Transport Areas and Market Areas into which Florida is divided. The new MFN core network between those core nodes is complete providing 150 Gbps in aggregate backbone capacity between LATAs.³¹⁶

14.3.4 MFN Competitive Access

The MFN contract with AT&T, provides for use of “competitive access” through which an agency may obtain its MFN access through SUNCOM, but from a supplier other than AT&T or one of the subcontracting incumbent local exchange providers. Section 4.3.33 of the MFN contract provides for competitive Local Loop Access Services as follows:

Promoting Competitive Access into Core: To promote competition, competitive access providers and their technologies shall be aggressively accommodated as necessary within the MyFloridaNet enterprise. Local access (local loops) of any DMS certified access technology from any DMS approved vendor shall be allowed to be integrated into the core. Contractor agrees to their

³¹⁴ *MyFloridaNet Contract*, Section 4.3.17 “Service Levels,” Section 4.3.18 “Receive Alerts and Service Credit Processes,” Section 4.4.13 “Performance Tools,” and Exhibit 2 which contains each Service Level Agreement and the related performance target, liquidated damages and measurement.

³¹⁵ Email from Danny Thomas, Area Director, Florida Government/Education, AT&T Southeast, dated January 17, 2011.

³¹⁶ E-mail from Danny Thomas, Area Director, Florida Government/Education, AT&T Southeast, dated January 17, 2011.

Figure 14-1. MFN Prior to Contract Extension

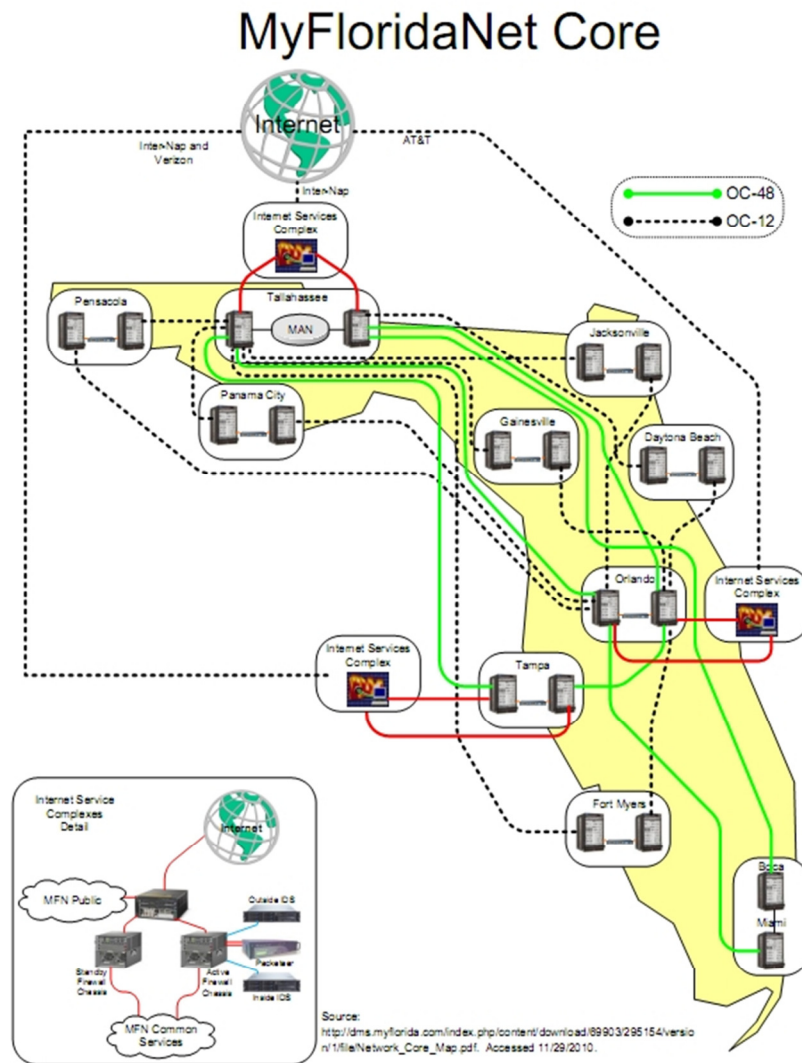

Source: DMS.

defined strategies to promote competitive access at the lowest cost. For example, Metropolitan Area Network (MAN) connectivity currently provides regional Eligible User aggregation plus access to the DMS network. As these and other options become viable, MyFloridaNet must quickly incorporate them as access options.

Contractor shall aggressively accommodate certified competitive access providers and their technologies within the MyFloridaNet enterprise.

Figure 14-2. MFN After Contract Extension

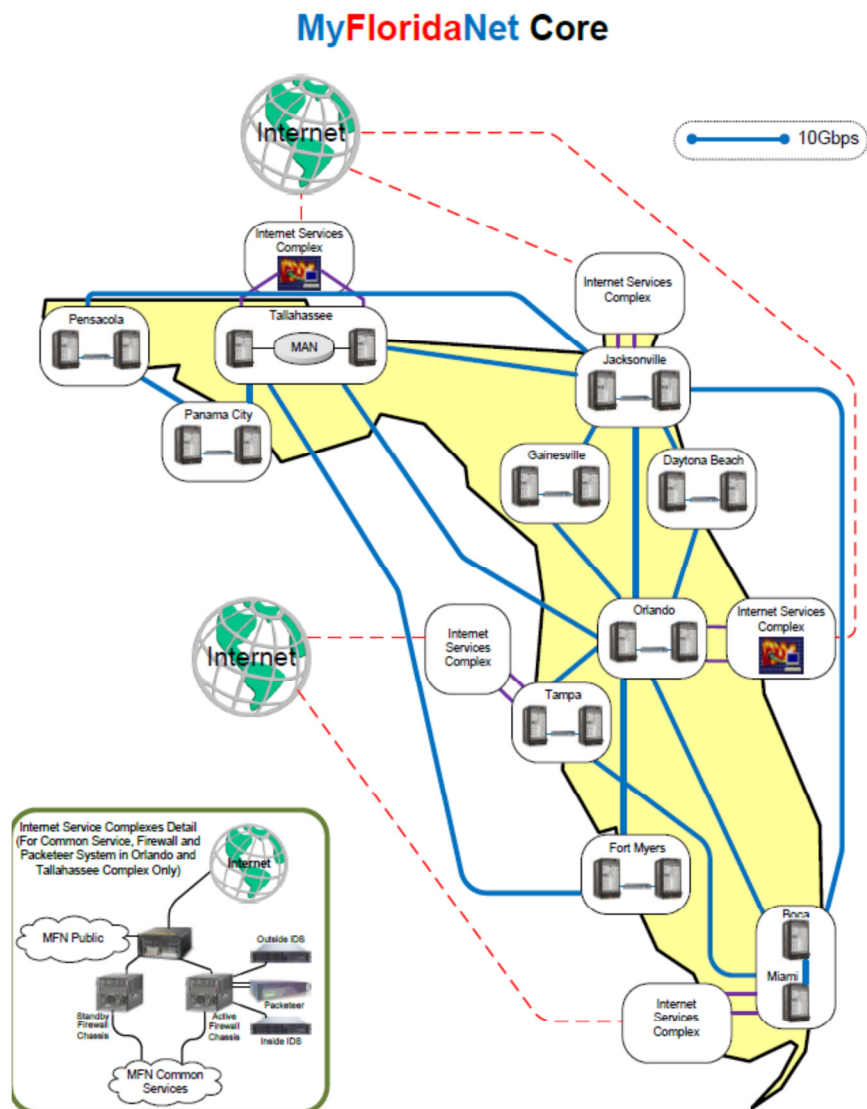

Source: DMS.

DMS shall insure fair and equitable treatment of all access providers. The ITN required the successful contractor to act much like a “carrier of last resort” and provide access to all sites under a statewide flat rate pricing model as detailed in Exhibit 3, Worksheet 1, Column F. Acting as a partner, DMS shall work to balance its need for competitive access prices with the recognition of the ‘last resort’ and flat rate requirements imposed on the Contractor.

14.3.5 Remote Broadband Service and MFN Access

Remote Broadband Service (RBS) is an existing SUNCOM service offering described as follows:

RBS utilizes the latest broadband “best effort” transport technology common to the consumer (rather than business) market. RBS provides cost-effective remote broadband access via Digital Subscriber Lines (DSL), which is digital transmission over the wires of the local telecommunications network. Eligible SUNCOM customers working from small offices and homes will be able to connect via the Internet to work-related resources.³¹⁷

RBS has not yet been used as an access option for MFN. DMS is validating RBS for use as an MFN access option, in addition to its current use for providing DSL connections for small government office locations. DMS is taking necessary steps to enable RBS to be used for connection to MFN in lieu of the local access element as a lower cost alternative access to MFN. Use of RBS will enable suitable locations to obtain MFN connection at higher speeds and one third the cost of a T-1 (1.544 Mbps) MFN connection.

Interviews with DMS staff and that of other agencies suggest a view that the variety of MFN network access choices will continue to expand, including for example, mobile communication devices including 4G (LTE) for agencies, and 4G (LTE) for public safety, as discussed below in the Mobile Broadband section.

14.3.6 MFN Contract Renewal and Extension

The contract for MFN services was extended and renewed for an additional five years on December 28, 2010.³¹⁸ The contract renewal provides for additional services for rate reductions.³¹⁹ The new contract also provides AT&T with “cost savings” by “replac[ing] the requirement of a diverse Tier 1 ISP [Internet Service Provider] with a single Tier 1 ISP.”³²⁰ This provision does not affect pricing to MFN customers, but reduces costs to the contractor in return for price reductions in the contract renewal. There are penalties for AT&T if its Internet service is below quality thresholds specified in the contract with DMS, with additional measurements included in the Contract Amendment.³²¹

DMS has estimated the annual savings from the rate reduction as \$2.2 million initial annual

³¹⁷ Department of Management Services, *Division of Telecommunications Business Model*, 15.

³¹⁸ *Amendment 5* to MyFloridaNet Contract, 1.

³¹⁹ *Ibid.*

³²⁰ *Ibid.*, 5. “A regional Tier 1 ISP is an ISP that has access to the entire internet region routing table solely through Peering relationships.” DrPeering International, “Tier 1 ISP.” “Tier 1 networks are those networks that don't pay any other network for transit yet still can reach all networks connected to the internet.” Van der Berg, “How the Net Works.”

³²¹ The Amendment states “The original Internet SLA requirement shall be clarified to incorporate the new single service ISP service measurement.” *Amendment 5* to MyFloridaNet Contract, Section 3.5. New Section 3.5.3 applies the current Internet SLA credits along with an additional measurement subject to liquidated damages on a per incident basis.

savings. This assumes no change in the current allocation of broadband capacities among users and is based on mid-year 2010 service volumes.³²² Rates are reduced for MFN Core with Frame Relay Access; MFN Core with Metro Ethernet access; MFN Core with Dedicated Access; and MFN Core with DSL access.³²³ The design of the price reductions encourages migration to higher bandwidth services. Furthermore, much of the price reduction is focused on the port price for Metro Ethernet. This has positive benefits for competitive access opportunities. A very significant feature of the MFN renewal is that access at higher bandwidth levels is now specifically priced versus the previous “Individual Case Basis” pricing. Stated pricing versus previous ICB treatment removes a significant unknown from analysis and decision-making. Price reductions are shown in Table 14-1.

The Contract Extension provides MFN Layer 2 InterLATA Service as an additional functionality.³²⁴ This service enables MFN customers connected to MFN over Metro Ethernet to extend their Ethernet Networks to any other MFN connection that they may have. This, in effect, gives MFN customers the ability to have “Regional” Ethernet Networks, connected over the MFN backbone. It is point-to-point with no routing capability. The service cannot be used in a point-to-multi-point scenario.

The contract renewal provides the following new services:

- Metropolitan Area Network Type 1³²⁵: Shared fiber network to provide for interconnection of Local Area Networks in Tallahassee, at speeds up to 10Gbps from the eligible user’s Local Area Network (LAN) to the Shared Tallahassee 2GMAN network. This is offered for local and intraLATA use with MFN Service Level Agreements applicable. MAN Types 2, 3 and 4 do not have full MFN support in contrast to MAN Type 1.
- Metropolitan Area Network Type 2³²⁶: Metro Ethernet service provided in all AT&T LATAs, at speeds ranging from 2 Mbps to 1 Gbps. This essentially creates 2G MANs in the AT&T footprint. It gives the Customer a fully supported service, all the MFN support and fail-over protection provided in the MFN backbone network. If you combine this with the Layer 2 InterLATA service, an extended, regional or statewide Ethernet Service could be possible. This adds performance, capability and some customization to MFN.

³²² Estimation provided by DMS.

³²³ “The current MFN DSL platform is End of Life (“EOL”) and it is anticipated that it will be discontinued before the end of the new MFN contract term. This will require that these customers migrate to a then current DSL or other offering as available.” *Amendment 5 to MyFloridaNet Contract*, 4.

³²⁴ *Amendment 5 to MyFloridaNet Contract*, 6.

³²⁵ *Amendment 5 to MyFloridaNet Contract*, 7.

³²⁶ *Ibid.*, 8.

Table 14-1. Effect of Rate Reductions from MFN Contract Extension

Bandwidth	Frame Relay						
	Rates Effective 1-1-10		Rates Effective via Extension		Price Change: Rates Effective v. Extension		
	Port	Local Loop	Port	Local Loop	Port	Local Loop	
64 Kbps	\$161.72	\$46.42	\$158.97	\$44.57	-1.70%	-3.99%	
128 Kbps	\$161.72	\$161.48	\$158.97	\$155.02	-1.70%	-4.00%	
256 Kbps	\$171.81	\$161.48	\$168.66	\$155.02	-1.83%	-4.00%	
512 Kbps	\$195.02	\$161.48	\$190.94	\$155.02	-2.09%	-4.00%	
768 Kbps	\$219.24	\$161.48	\$214.19	\$155.02	-2.30%	-4.00%	
1.5 Mbps	\$334.29	\$161.48	\$324.65	\$155.02	-2.88%	-4.00%	
3 Mbps	\$530.39	\$287.63	\$532.45	\$276.66	0.39%	-3.81%	
6 Mbps	\$935.90	\$536.91	\$897.05	\$504.70	-4.15%	-6.00%	
9 Mbps	\$1,388.85	\$817.47	\$1,309.20	\$768.42	-5.73%	-6.00%	
12 Mbps	\$1,541.04	\$897.20	\$1,436.05	\$843.36	-6.81%	-6.00%	
15 Mbps	\$1,639.75	\$942.62	\$1,510.96	\$886.06	-7.85%	-6.00%	
21 Mbps	\$2,025.90	\$1,156.57	\$1,834.92	\$1,087.17	-9.43%	-6.00%	
33 Mbps	\$2,349.08	\$1,286.76	\$2,052.97	\$1,209.56	-12.61%	-6.00%	
45 Mbps	\$2,671.25	\$1,415.94	\$2,264.09	\$1,330.98	-15.24%	-6.00%	
	Metro Ethernet						
2 Mbps	\$503.87	\$273.25	\$486.53	\$261.71	-3.44%	-4.22%	
4 Mbps	\$571.67	\$401.44	\$560.26	\$376.49	-2.00%	-6.22%	
6 Mbps	\$654.22	\$629.08	\$632.26	\$591.34	-3.36%	-6.00%	
8 Mbps	\$686.83	\$641.79	\$653.04	\$601.89	-4.92%	-6.22%	
9 Mbps	\$703.14	\$648.15	\$664.63	\$609.26	-5.48%	-6.00%	
10 Mbps	\$729.42	\$667.21	\$684.16	\$627.18	-6.20%	-6.00%	
12 Mbps	\$770.00	\$690.76	\$711.26	\$649.31	-7.63%	-6.00%	
15 Mbps	\$830.86	\$724.40	\$750.59	\$680.94	-9.66%	-6.00%	
21 Mbps	\$1,032.48	\$889.24	\$901.11	\$835.88	-12.72%	-6.00%	
33 Mbps	\$1,243.98	\$989.04	\$1,014.17	\$929.70	-18.47%	-6.00%	
45 Mbps	\$1,455.47	\$1,088.84	\$1,121.25	\$1,023.51	-22.96%	-6.00%	
90 Mbps	\$2,478.14	ICB	\$1,626.59	\$1,337.11	-34.36%	Now Priced	
100 Mbps	\$2,585.14	ICB	\$1,642.02	\$1,768.34	-36.48%	Now Priced	
155 Mbps	\$4,105.77	ICB	\$2,535.97	\$1,959.78	-38.23%	Now Priced	
200 Mbps	\$4,853.59	ICB	\$2,821.24	\$2,115.69	-41.87%	Now Priced	
300 Mbps	\$6,415.42	ICB	\$4,188.76	\$2,476.32	-34.71%	Now Priced	
400 Mbps	\$7,977.25	ICB	\$4,982.98	\$2,841.82	-37.54%	Now Priced	
500 Mbps	\$9,539.07	ICB	\$5,767.61	\$3,207.34	-39.54%	Now Priced	
622 Mbps	\$11,100.89	ICB	\$6,427.07	\$3,581.09	-42.10%	Now Priced	
700 Mbps	\$12,075.02	ICB	\$6,802.12	\$3,900.43	-43.67%	Now Priced	
800 Mbps	\$13,049.15	ICB	\$7,054.71	\$4,228.03	-45.94%	Now Priced	
900 Mbps	\$14,023.28	ICB	\$7,303.97	\$4,555.64	-47.92%	Now Priced	
1000 Mbps	\$14,997.40	ICB	\$7,565.51	\$4,894.51	-49.55%	Now Priced	

Sources: Department of Management Services, "Rate Schedule." DMS rate analysis from *Amendment 5* to MyFloridaNet Contract Dated September 18, 2006.

- Metropolitan Area Network Type 3³²⁷: Ethernet service provided in available CenturyLink LATAs, at speeds ranging from 3 Mbps to 1 Gbps. This MAN is only available where fiber facilities exist. CenturyLink has provided a list of Metropolitan areas where they will provide this service. Pricing is determined by which “zone” or metropolitan area the service will be deployed.
- Metropolitan Area Network Type 4³²⁸: Ethernet service provided in the Tampa LATA by Verizon, at speeds of 10 Mbps, 100 Mbps, and 1000 Mbps. This is a limited MAN service offered by Verizon. It permits Verizon as an alternate access to MFN in the Tampa LATA. It also permits Verizon or Hayes, or a Verizon and Hayes, partnership to offer this service outside of the Tampa LATA as long as it is not offered in the AT&T or CenturyLink service areas. It allows a best effort limited service.
- MFN Primary Data Center Services³²⁹: This service provides a MPLS network that connects the 3 datacenters. It also provides connections to the MFN backbone. This service permits the aggregation of multiple private agency VFRs. This is a Tallahassee Data Center specific service. It appears conceived to meet all possible Data Center requirements.

Other items provided by the contract renewal include:

- Additional Dedicated Engineer: an additional AT&T engineer dedicated to MFN operations for each 1,000 additional sites or for each additional \$5 million in contract revenue;³³⁰
- Additional Dedicated Security Engineer: addition of “an additional [AT&T] Security Engineer dedicated to MFN. Semiannually, Contractor shall perform a detailed and professional vulnerability test and assessment of all MFN components. The detailed professional report shall include, but not be limited to, an assessment, test, recommendations and fixes resulting from the vulnerability test.”³³¹ The Security Engineer will also assist MFN Eligible Users with the goal of increasing those Eligible Users’ security posture. This position would be the point of contact for new projects focused on assisting the increase of Eligible Users network security through assessment, infrastructure change, risk mitigation or policy compliance.”³³²
- Facilitation of the DMS Security Mission: While agencies are responsible for the security of both hardware and software products used under rules established by DMS

³²⁷ Ibid., 12.

³²⁸ Ibid., 16.

³²⁹ Ibid., 17.

³³⁰ *Amendment 5 to MyFloridaNet Contract*, 20.

³³¹ Ibid., 20-21.

³³² Ibid., 21.

and AEIT, “in the case of a premises device, the Contractor agrees to configure security services under the provider managed fee (configuration management fee). Infrastructure provided within MFN shall be required to facilitate the DMS’s security mission. Contractor shall provide the interface that shall allow DMS to respond to the various security compliance audits, training & awareness, policy development and appropriate rule, as well as the development of best practices.”³³³

- Three types of Local Switch Management services:³³⁴ These three services will consist of “Local Area Network (LAN) Ethernet Switch Equipment and the monitoring of these switches. Eligible Users shall have ability to rent SUNCOM qualified LAN Ethernet Switching equipment using the current MFN CPE formula and options.”³³⁵ We note these services are available in each of the four states that were compared with Florida. The service appears to be designed to help customers who want to use their resources for other tasks. It helps inexperienced users install an Ethernet network, and it relieves new and experienced users of the burden of determining the best Ethernet switch to purchase or use and providing the required level of management. In effect, it appears to be an option to outsource an Ethernet network.

The three services are as follows:

- the basic service (including the rental, maintenance and basic report management of LAN Ethernet switch equipment),
- the standard service (including the rental, maintenance and the MFN monitoring of LAN Ethernet switch equipment through the MFN NMS Tools without any NetFlow reporting), and
- the Enhanced Service (including the rental, maintenance and the MFN monitoring of LAN Ethernet switch equipment with 24*7*365 proactive monitoring, NetQOS and monthly service review).

DMS and Eligible Users shall not be required to subscribe to these MFN-LSM services. These services shall be provided with no SLA penalties.

- MFN Managed Firewall Services:³³⁶ This service can free up agency resources. An agency would no longer have to buy firewall equipment and software, or update the firewall capability to respond to new security threats. Managed firewall takes a security “headache” off of the customer list of responsibilities. Managed firewall should cost less and makes available AT&T security engineers to address and solve security problems.
 - This service will permit “monitoring of events occurring in the MFN Wide Area

³³³ Ibid., 31.

³³⁴ Ibid., 22-24.

³³⁵ Ibid., 22.

³³⁶ Ibid., 25.

Network (WAN) and analyze them for signs of possible incidents which are violations or imminent threats of violation of security policies, acceptable use policies, or standard security practices.”³³⁷

- **MFN Remote Access Virtual Private Network Service:**³³⁸ Facilitates network neutral access permitting other SUNCOM services to utilize this technology as a means to access MFN resources. Virtual Private Network (VPN) services described here will permit RBS and other Remote Access services that were previously not permitted access to the MFN Network because of security risk to use VPN access to the MFN. VPN provides the security guarantee required by MFN. The remote service and the network it uses to access MFN becomes a Virtual Private Network, a VPN.

14.3.7 Mobile Broadband

14.3.7.1 AirCard Service

Mobile broadband is a service which is viewed as very important by a number of agencies, for example Department of Children and Families and the Florida Department of Law Enforcement (FDLE). The growing prevalence of smart devices and increases in data transmission speeds achieved by mobile broadband providers is adding to the importance of mobile broadband.

SUNCOM currently provides mobile broadband capability through its AirCard Service.³³⁹ “SUNCOM’s mobile services partners include AT&T, Sprint and Verizon.”³⁴⁰ This service “enables laptop computers to mobile access the Internet or State Network through SUNCOM’s secure and encrypted Virtual Private Network service.”³⁴¹

14.3.7.2 Mobile Communication Services Procurement

DMS has a procurement open for both data and voice mobile communication services.³⁴² The procurement seeks “the comprehensive set of Wireless Voice Services, Wireless Data Services, billing services, customer care services operational services, equipment services and other related services.”³⁴³ Wireless Voice Services are “the Cellular Radio Service (cellular), Personal Communications Service (PCS) and the Special Mobile Relay (SMR/ESMR) radio telephone services, as established under the rules and regulations of the Federal Communications

³³⁷ Ibid., 25.

³³⁸ Ibid., 26.

³³⁹ Department of Management Services, “Wireless Data Services: AirCard.”

³⁴⁰ Department of Management Services, *Division of Telecommunications Business Model*, 16.

³⁴¹ Ibid.

³⁴² Department of Management Services, *Invitation to Negotiate for Mobile Communication Services*.

³⁴³ Ibid., 5.

Commission (FCC).”³⁴⁴ Wireless Data Services are “the TCP/IP based mobile data communications service accessed via a wireless modem (or other appropriate device) utilizing 3G technology and/or greater (4G desired). Unless specified otherwise in a Response, 3G and 4G are defined (at a minimum) to maintain a continuous 80Kbps and 500Kbps transmit/receive data throughput rate, respectively.”³⁴⁵ Provision of 4G mobile data communications appears to be converging on LTE or “Long Term Evolution” as deployed by such large mobile providers as Verizon. This convergence on LTE also has implications for Public Safety as described in Section 19.

The Mobile Communication Services procurement in overview is as follows:

The State of Florida currently purchases wireless voice and data communication services from a variety of sources. Some government entities buy the services using the Western State Contract Alliance (WSCA) contract. Others buy wireless voice services using Florida’s voice state term contract with Verizon Wireless. Still others buy smart phones and aircards through DivTel’s contracts with AT&T Mobility, Sprint and Verizon Wireless. Other government entities procure the services on their own.

This decentralized system dilutes the bulk purchasing power of the state and causes customer confusion. DivTel seeks to improve the current process by issuing this comprehensive ITN and incorporating the Services within its SUNCOM Network. In accordance with Section 282.703, Florida Statutes, the DivTel will purchase the Services directly from the selected wireless provider and DivTel will be solely responsible for billing the SUNCOM Clients. The wireless provider’s responsibilities with regard to product ordering, fulfillment, billing, customer care, reporting and other matters are set forth in Section 4 of the ITN.

The Services requested in this ITN do not include wireless LAN technology infrastructure. However, Respondents are requested to provide information and pricing on other enhanced services such as wireless VoIP integration, WI-FI capable phone(s), and Wireless Cellular Radio Modem Router functionality technologies. The prospective contract(s) may incorporate these and other wireless features, services, products and technologies as they are introduced by the provider so long as such incorporation is within the scope of such contract(s).

³⁴⁶

³⁴⁴ Ibid.

³⁴⁵ Ibid.

³⁴⁶ Ibid., 5-6. As stated at page 6 of the ITN, the contract resulting from the ITN is anticipated to have an initial term

The Mobile Communication Services Invitation to Negotiate (ITN) illustrates a DMS objective to use the MFN to transport eligible user communications originating from a number of access methods—in this case mobile devices, but also including other methods noted earlier such as RBS. It is contemplated that mobile communication devices will be able to interconnect and be a form of access to MFN. Figure 14-3 shows the interconnection of the Wireless IP cloud to MFN that is visualized.³⁴⁷

14.3.7.3 Additional Broadband Options

DMS provides additional broadband options beyond those described earlier for schools and libraries (FIRN2), and MAN arrangements.

14.4 Florida Lambda Rail (FLR)³⁴⁸

FLR is the statewide research and education network in Florida. FLR’s mission is to provide “a sustainable optical backbone for research, education, and economic development by expanding outward from a core of research universities equity investors to include a growing cadre of fee-for-service affiliates with applications in the research, education and economic development arenas.”³⁴⁹ FLR’s network is designed to reach all Florida’s public or private, nonprofit educational or research organizations, and thus is statewide. Affiliates are able to connect through the state universities or directly at other nodes in the network.

14.4.1 FLR Funding and Membership

Funding comes from 12 Florida research universities that are Equity members and from affiliate organizations. Equity members include: Florida Atlantic University, Florida Gulf Coast University, Florida International University, Florida Institute of Technology, Florida State University, Nova Southeastern University, University of Central Florida, University of Florida, University of Miami, University of North Florida, University of South Florida, and University of West Florida. Affiliates include not-for-profit private universities, other state universities, several community colleges, the Florida College Center for Library Automation, the Northwest Regional Data Center, the Florida Department of Education, Orange County, Orange County Public School District via Education Networks of America, Palm Beach County, and several research and medical institutes. FLR receives no direct state funding through the appropriation

of five years, and may be renewed for up to five years.

³⁴⁷ Ibid., 77.

³⁴⁸ Review of this section was requested January 11, 2011 and timely received from Veronica Sarjeant and David Pokorney of Florida LambdaRail in time for final publication of this report. We appreciate and acknowledge the review of this section provided by FLR.

³⁴⁹ Florida LambdaRail, *Bi-Annual Report*, 5.

process and has received no federal stimulus funding as of November 12, 2010.³⁵⁰

Figure 14-3. Wireless IP Cloud Interconnection to MFN

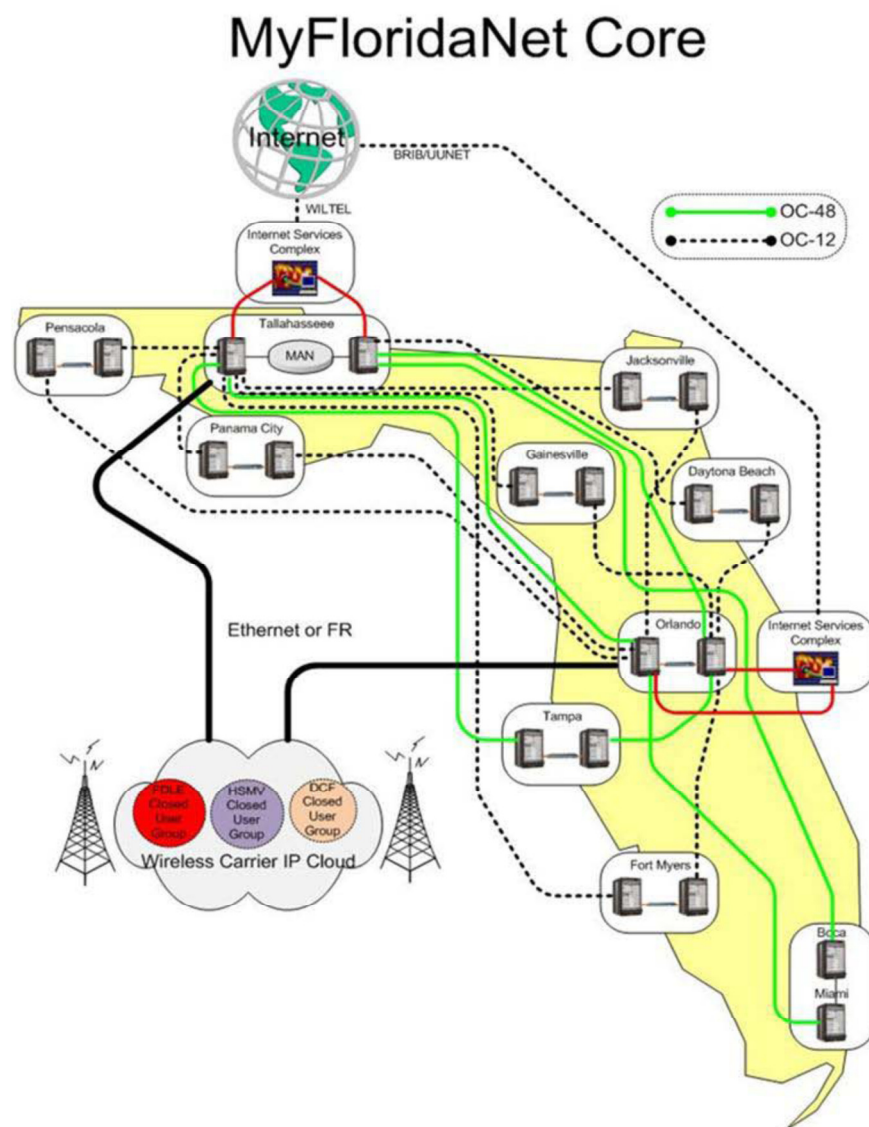

Source: Department of Management Services, *Invitation to Negotiate for Mobile Communication Services*, p. 77.

³⁵⁰ Florida LambdaRail collaborated on a SmartNet proposal with others but it was not funded. According to Veronica Sarjeant, COO, Florida LambdaRail, if the grant had been awarded, it would have opened up points of presence for Florida LambdaRail. Interview by David Brevitz (via teleconference), Lynne Holt, Mary Galligan, Narongpol Chotset, Public Utility Research Center, University of Florida, with David Pokorney, Phil Halstead (via teleconference), Veronica Sarjeant (via teleconference), Florida LambdaRail, Gainesville, November 12, 2010. For information on SmartNet, see Florida College System, *Florida Smart Net*.

There are differences in the benefits provided Equity members and Affiliate participants. Equity members subscribe to a level of ownership based upon unit shares. Each unit share represents an amount of capitalization and cost of services. Equity member payments to FLR as well as Board voting rights are based on those units. Affiliate participants pay a one-time participation fee and cost of services.³⁵¹

Affiliate participants gain access to the network infrastructure on a fee-for-service basis through an Equity member's network or a direct connection.³⁵² Affiliate participants have no voting rights or equity interest in FLR.

14.4.2 FLR Network

FLR has been in “full production” for more than five years. The network backbone is 1,540 miles of optical fiber obtained under a 20-year lease³⁵³ from Level 3 Communications Inc.³⁵⁴ FLR has leased 2 fibers.³⁵⁵ The network is a facilities-based dense wavelength division multiplexing (DWDM) optical network initially configured with 32 lambdas (wavelengths), expandable to 80 lambdas. Participants are able to connect through an equity member's network or directly at one or more of twelve points of presence on the network.

FLR offers two types of service:

1. FLRNet:
 - a. Dynamic Bandwidth Allocation
 - b. Connectivity to advanced production regional and national networks, such as the NLR and Internet2 backbones.
 - c. High speed IP transit paths between participants, supporting both IPv4 and IPv6 protocols.
 - d. Network peering between the FLR and other content data networks, in addition to local peering.
 - e. Access to the Internet2 Sponsored Education Group Participant program.³⁵⁶
 - f. Connectivity to commercial Internet Service Providers. FLR has contracts with three vendors with two connections to each, so that if one vendor's connection

³⁵¹ The information was supplied by Veronica Sarjeant. Interview by David Brevitz (via teleconference), Lynne Holt, Mary Galligan, Narongpol Chotset, Public Utility Research Center, University of Florida, with David Pokorney, Phil Halstead (via teleconference), Veronica Sarjeant (via teleconference), Florida LambdaRail, Gainesville, November 12, 2010.

³⁵² Florida LambdaRail, *Bi-Annual Report*, 2 and 5.

³⁵³ Interview by David Brevitz (via teleconference), Lynne Holt, Mary Galligan, Narongpol Chotset, Public Utility Research Center, University of Florida, with David Pokorney, Phil Halstead (via teleconference), Veronica Sarjeant (via teleconference), Florida LambdaRail, Gainesville, November 12, 2010.

³⁵⁴ Florida LambdaRail, “Infrastructure.”

³⁵⁵ Interview meetings between FLR management and David Brevitz and Herb Cash.

³⁵⁶ Florida LambdaRail, *Bi-Annual Report*, 15.

fails traffic can be transferred to the other.

- g. The FLRNet 20Gbps backbone links will be upgraded to 100 Gbps when researchers require this level of service.
2. FLRWave: Dedicated wavelengths, point-to-point 1.0, 2.5, 10 or 40 gigabits per second optical lambdas, offered as a complement to the FLRNet backbone services.

Characteristics of the FLR network include:

- FLR does not provide the “last mile” connection to its network. Each equity or affiliate member is responsible for procuring and provisioning the “last mile” connection to the FLR network. “FLR has available to them a number of different methods for connecting to the last mile. One example is in Tallahassee where a consortia has a local fiber loop that is made available to sites wanting to connect to FLR. Another example, Bright House Networks, a commercial vendor, provides deep discounts to the educational sector. FLR also have used local fiber builds, cable companies, city utilities, and are currently engaged in discussions with energy companies for the last mile access.”³⁵⁷
- FLR sells a port on the network providing the bandwidth purchased by the user. The customer is responsible for the local loop and any premise equipment needed to connect to the FLR port.
- FLR has no acceptable use policy constraints beyond those required by law. The network can be used for any legal purposes, so long as it does not interfere with or adversely affect operations of the FLR network or other connecting regional or national research networks (i.e., National LambdaRail, Internet2)³⁵⁸.
- The FLRNet is capable of supporting Quality of Service (QOS). With FLRNet's 20Gbps over-provisioned backbone, QOS has not been a requirement or requested to-date by its membership.³⁵⁹ The necessity of such QOS requirement may be obviated by the fact that FLR is owned by its members.
- FLR does not provide SLAs. FLR transports traffic on a “best efforts” basis. The network is designed and has delivered 99.999 percent carrier class availability.³⁶⁰
- FLR Participants have demonstrated ability to tap the inherent capacity of fiber and create a less expensive and more flexible network, gaining access to virtually unlimited bandwidth with a potential carrying capacity of more than a terabit of data per second and a secure, long-term investment. The implemented solution is a 20-Gbps (20 billion bits per second) infrastructure, carried over redundant optical fiber strands.³⁶¹

³⁵⁷ Florida LambdaRail, *Case Study, 2*.

³⁵⁸ Veronica Sarjeant. Written communication to David Brevitz. January 14, 2011.

³⁵⁹ Veronica Sarjeant. Written communication to David Brevitz. January 14, 2011.

³⁶⁰ Veronica Sarjeant. Written communication to David Brevitz. January 14, 2011.

³⁶¹ Veronica Sarjeant. Written communication to David Brevitz. January 14, 2011.

- As the bandwidth needs of the participating institutions increase, only the optical equipment that lights the fiber will need to be upgraded.³⁶²
- The FLR NOC is staffed for continuous, 24 x 365 (including holidays) monitoring of the FLR statewide optical network, and coordinates restoration of any failures that may surface during the operation of the network.
- FLR’s web-based network management system includes Traffic level statistics, outstanding and open tickets, five-minute snapshot of existing network alarms. Members may submit commands to FLRnet routers via the Looking Glass portal.

14.4.3 FLR Operations and Services

FLR operates as a highly outsourced company. Authority and oversight is centralized and invested in a Board of Directors augmented by the necessary delegations of authority and operational management required to effectively and efficiently conduct operations. Support services (e.g., administrative, financial, legal, and network operations) are contracted services from Equity member institutions.³⁶³

FLR obtains Network Operations Center functions under contract with the University of Florida, with approximately five full-time equivalent employees. There is no need for further network staff since FLR operates the backbone network, while participants are responsible for the procurement and management of “last mile” connectivity and customer premise equipment. The network is operated without strictly defined Quality of Service objectives enforced by a Service Level Agreement, but FLR supports the Quality of Service protocol. However, with FLRNet’s 20Gbps over-provisioned backbone, Quality of Service has not been a requirement or requested to-date by its membership.³⁶⁴

Participant payments for use of FLR services are due and payable on a quarterly basis. FLR’s services include high-speed fiber optic network services which include dedicated waves, network peering, network aggregation services, IP transit between participants, connectivity to advanced regional and national networks, a form of bandwidth management referred to as “dynamic bandwidth allocation,” and connectivity to commercial Internet Service Providers.³⁶⁵ As a member of Quilt, a national consortium of educational institutions, FLR obtains Internet service for its members at a discounted rate.³⁶⁶

³⁶² Veronica Sarjeant. Written communication to David Brevitz. January 14, 2011.

³⁶³ Veronica Sarjeant. Written communication to David Brevitz. January 14, 2011.

³⁶⁴ Veronica Sarjeant. Written communication to David Brevitz. January 14, 2011.

³⁶⁵ Florida LambdaRail, *Bi-Annual Report*, 4.

³⁶⁶ *Ibid.*, 15.

14.4.4 Geographic Extent of Florida LambdaRail Network

Figure 14-4. Florida LambdaRail Network Map

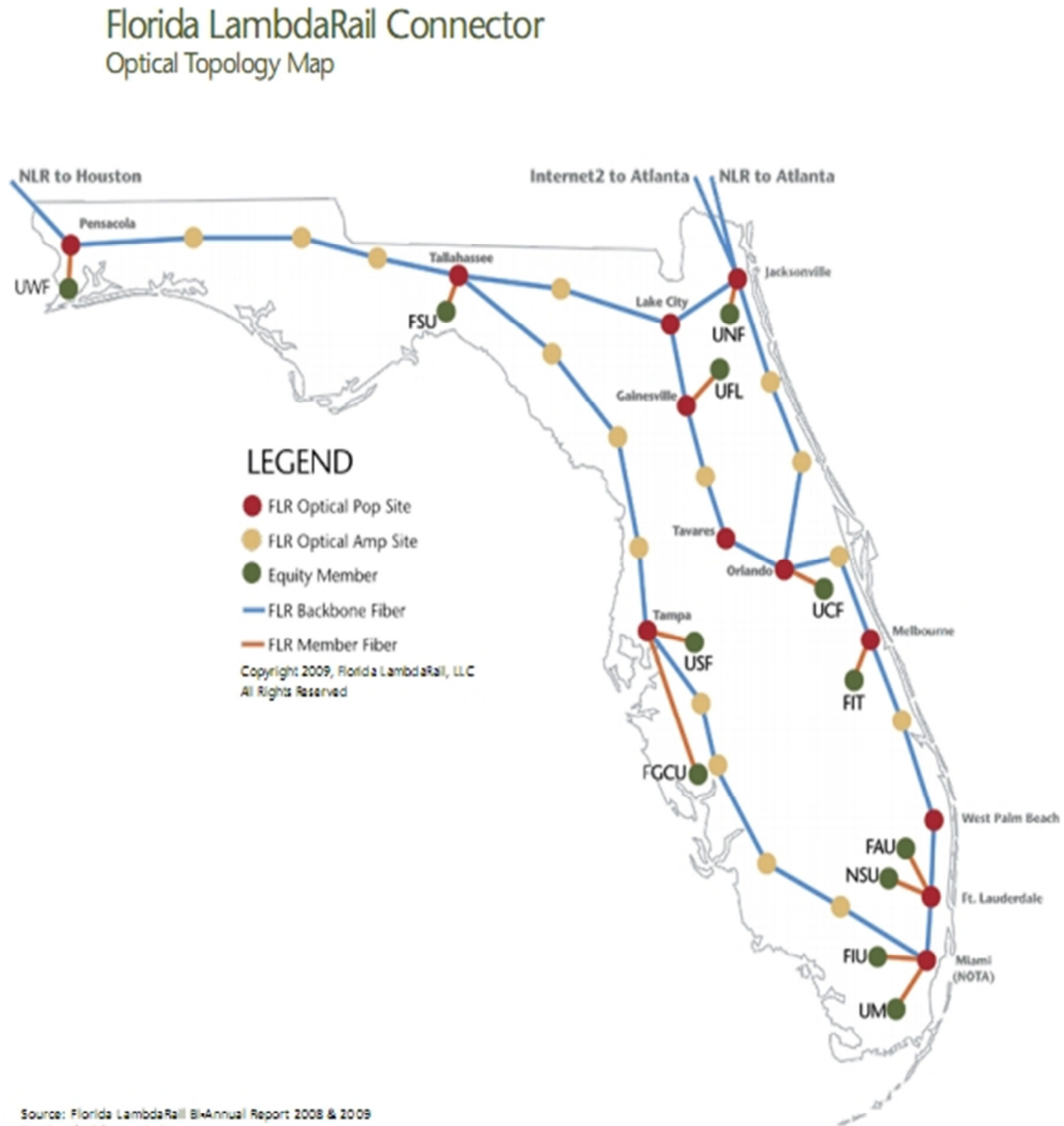

14.4.5 Interconnection Between MFN and FLR

Discussions have occurred between FLR and DMS representatives regarding the benefits and possibility of interconnecting the two networks.³⁶⁷ The graphics below describe in summary form the elements of those discussions in 2007. Figure 14-5 provides FLR’s view of the benefits of this interconnection. According to FLR, the benefits listed resulted from May 2007 discussions between FLR and DMS.

Figure 14-5. FLR/MFN Interconnection View

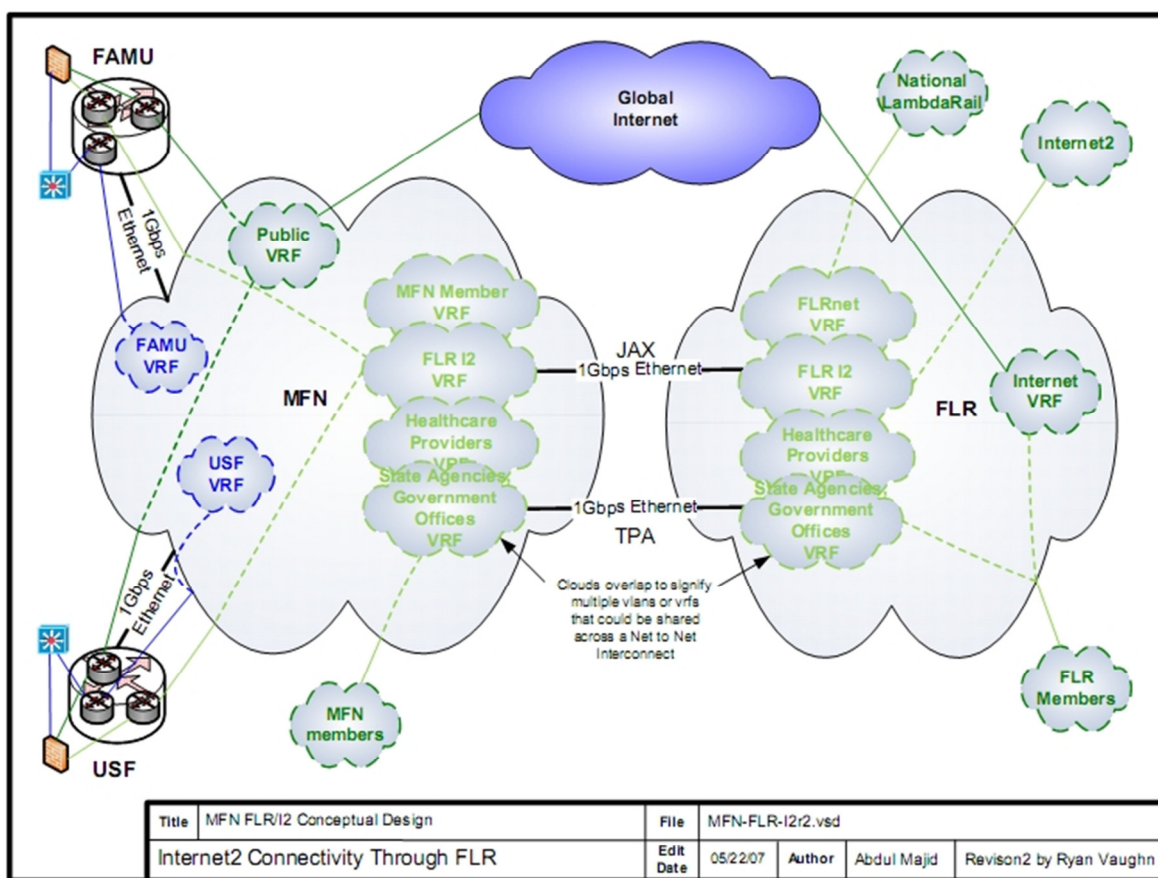

Create PDF files without this message by purchasing novaPDF printer (<http://www.novapdf.com>)

Source: FLR.

³⁶⁷ This information was furnished during an interview by David Brevitz (via teleconference), Lynne Holt, Mary Galligan, Narongpol Chotset, Public Utility Research Center, University of Florida, with David Pokorney, Phil Halstead (via teleconference), Veronica Sarjeant (via teleconference), Florida LambdaRail, Gainesville, November 12, 2010.

Benefits of Interconnectivity

- Alternative methods for FLR Members to purchase circuits and local loops from MyFloridaNet for remote campus and distance education sites.
- Provide enhanced and secure interconnectivity between Public Health Care facilities located on FLR Member sites and Department of Health facilities throughout the state on the MyFloridaNet network.
- Provide enhanced and secure interconnectivity between state agencies (Inspector General, DPI, etc (sic)) located on FLR Member sites and government facilities throughout the state on the MyFloridaNet network.
- Potential increased revenue through the ability to offer additional connectivity and services to both Florida LambdaRail and MyFloridaNet connectors.
- High-Speed Low-Latency Network to Network Peering
- Zero Cost Interconnection
- Interconnection could be 1G, multiple 1G, or 10G
- MyfloridaNet (sic) and Florida LambdaRail could peer in multiple locations for increased resiliency.
- Enhanced access between members of MyfloridaNet (sic) and Florida LambdaRail
- Access to FLR Members and R&E Peers National LambdaRail and Internet2
- Access to MyFloridaNet Members
- Dedicated private VPNs across both Networks for secure and isolated access.
- Increased benefit to current and future members of access to more sites without using the Internet.

Source: David Pokorney, Florida LambdaRail, November 2010.³⁶⁸

Such interconnectivity might have benefits for the base of state agencies as well. For example, there is an interest in using FLR to support disaster recovery (e.g., AEIT³⁶⁹), and to support Geographic Information Systems (GIS) file transfers (e.g., Fish and Wildlife Conservation Commission³⁷⁰ (FWC) and Division of Emergency Management³⁷¹). For FWC, use of FLR for the large file transfers associated with GIS would solve what appears to be significant conflict between the requirement to use MFN to do GIS file transfers at night to avoid impacting systems during normal work hours, and also the need to back up systems at night (off hours) as a matter

³⁶⁸ Veronica Sarjeant. Written communication to David Brevitz. January 14, 2011.

³⁶⁹ Interview by David Brevitz and Herb Cash, Public Utility Research Center, University of Florida, with David Taylor, Executive Director/State CIO, Agency for Enterprise Information Technology, December 10, 2010.

³⁷⁰ Interview by David Brevitz, Public Utility Research Center, University of Florida with Kevin Patten, Office of Information Technology, Florida Fish and Wildlife Commission, September 8, 2010.

³⁷¹ Interview by David Brevitz and Herb Cash, Public Utility Research Center, University of Florida, with Richard Butgereit, GIS Administrator, Florida Division of Emergency Management, September 29, 2010,

of routine. FWC shares GIS with FDOT and Department of Environmental Protection.³⁷² The ability to use FLR for GIS file transfer, and MFN for systems backup might also save money as FWC has had to install a 100Mb connection in St. Petersburg for FWC GIS, when 10Mb would otherwise be sufficient for FWC agency operations.³⁷³ There are three major GIS data centers in Florida, where FLR connections are needed. Agencies are building the same files because infrastructure and organization are not coordinated.³⁷⁴ Also, some agencies have a research component to the agency mission as well as a university presence, such as Fish and Wildlife Conservation Commission, for which FLR interconnectivity is a need and natural fit.³⁷⁵

Nonetheless, DMS and FLR state that they intend to explore additional aspects of this potential interconnection, including:

- The extent to which FLR services and networks can support the same level of performance and security requirements that are provided and required of MFN for Public Health Care facilities;
- The extent to which FLR services and networks can support the same level of performance and security requirements that are provided and required of MFN for state agencies located on FLR member sites; and,
- The value of access to National LambdaRail and Internet2 for MFN eligible users.

14.5 Florida Department of Transportation's Intelligent Transportation System³⁷⁶

14.5.1 ITS in Florida

“Intelligent Transportation Systems (ITS) represent the application of technologies involving information processing, communications, control, and electronics to improve our transportation system by saving lives, time, and money.”³⁷⁷ ITS depend upon extensive communications networking, especially fiber optic facilities and related electronics and structures. FDOT accelerated deployment of ITS with the Ten-Year ITS Cost Feasible Plan developed in 2002.

³⁷² Interview by David Brevitz and Herb Cash, Public Utility Research Center, University of Florida with Kevin Patten, Office of Information Technology, Florida Fish and Wildlife Commission, December 9, 2010.

³⁷³ Ibid.

³⁷⁴ Interview by David Brevitz and Herb Cash, Public Utility Research Center, University of Florida, with Richard Butgereit, GIS Administrator, Florida Division of Emergency Management, September 29, 2010,

³⁷⁵ Interview by David Brevitz and Herb Cash, Public Utility Research Center, University of Florida with Kevin Patten, Office of Information Technology, Florida Fish and Wildlife Commission, December 9, 2010.

³⁷⁶ Review of this section was requested January 11, 2011 and timely received from Elizabeth Birriel and Randy Pierce of Florida Department of Transportation ITS in time for final publication of this report. We appreciate and acknowledge the review of this section provided by FDOT ITS.

³⁷⁷ Intelligent Transportation Society of Florida, *ITS Florida*.

That initial plan provided for the deployment of ITS using \$496 million set aside by FDOT’s Executive Board.³⁷⁸ According to FDOT, “Prior to the Executive Board’s dedication to a statewide ITS deployment through the provision of funding resources, the Districts had to scratch out funds from their budgets to deploy ITS. ITS projects were in direct competition for funding with traditional concrete and asphalt projects.”³⁷⁹

ITS projects are planned, constructed/deployed and managed by FDOT districts on a geographic basis and the Florida Turnpike Enterprise under FDOT ITS Program Office policies and procedures. Each of the seven FDOT districts plus the Turnpike Enterprise has management authority to build and operate facilities in its district, using funding obtained from FDOT ITS Program Office (hereafter called “Central Office”), with limited ITS-specific responsibilities—the Central Office establishes funding levels by year and appropriates funds to the districts. District management has operational authority within the individual districts under policies and procedures established by the Central Office. The districts use Regional Transportation Management Centers (RTMC) as part of the management organization structure. Each district manages the network by itself with RTMCs. Districts 1 and 4 and the Florida Turnpike Enterprise use SunGuide ® software in their network management.³⁸⁰

FDOT and its districts have deployed substantial fiber optic communications networking throughout the State of Florida using federal ITS funding, although there are areas without fiber optics (*e.g.*, I-10 corridor, and I-75 from Tampa north to the Georgia state line³⁸¹) where microwave radio transmission networking is used. FDOT has connected two district networks via Wide Area Networking. FDOT’s current ITS plan covers deployment on 1,260 miles of freeway (60 percent) by 2014.³⁸² “At the end of June 2010, over 1,100 miles of limited-access roadways had ITS deployments (54% of the limited-access Florida Intrastate Highway System); however, we have rural interstates on which ITS infrastructure has not been deployed. We explored and found alternate data collection sources to feed information into our statewide 511 advanced traveler information system; thereby, enhancing information provided to travelers in

³⁷⁸ Florida Department of Transportation, *Intelligent Transportation Systems Program Annual Report Fiscal Year 2009-2010*, 14.

³⁷⁹ *Ibid.*

³⁸⁰ Florida Department of Transportation, *Intelligent Transportation Systems Program Annual Report Fiscal Year 2009-2010*, 6. SunGuide ® software is used by regional transportation management centers “to monitor and control traffic monitoring devices and record traffic and event conditions on a 24/7/365 basis.” “Beyond traffic management functionality, RTMC operators can use SunGuide to report conditions directly to FL-ATIS, thereby informing the traveling public.” Additional Districts will be implementing SunGuide ® as well. *Ibid.*, 19.

³⁸¹ Florida Department of Transportation, *Intelligent Transportation Systems Program Annual Report Fiscal Year 2008-2009*, 12. Fiber for these routes was not in the 5 year work program as of 2009 per FDOT, and is not on the planning horizon at this time.

³⁸² Intelligent Transportation Society of Florida, *Intelligent Transportation Systems*.

rural areas of our state.”³⁸³ “FDOT made significant investments in ITS and is committed to investing approximately \$929 million between 2002 and 2020.”³⁸⁴ ITS is a system, and this total investment figure includes more than just fiber optic communications facilities.

FDOT ITS contracted in June 2010 to begin a Video Aggregation System Phase II project that will make full-motion video available to the public through the FL511.com website.³⁸⁵ The Video Aggregation System (VAS) is part of Florida’s Advanced Traveler Information System (FL-ATIS). VAS “provides the public with access to images from FDOT’s statewide closed-circuit television (CCTV) cameras. Counting the seven FDOT districts, Florida’s Turnpike Enterprise, Miami-Dade Expressway Authority, and the Orlando-Orange County Expressway Authority, there are about 1,600 CCTV cameras available for distributing images. FDOT anticipates that this number will expand to more than 2,000 CCTV cameras in the next few years. VAS II will utilize the ITS wide area network.”³⁸⁶

Also, FDOT provides wireless internet access for Florida Facilities such as traffic information (511), weather information, road conditions, and tourist attractions.

Research conducted for this project indicates counties have deployed extensive traffic management networking as well. For example, Palm Beach County’s ITS networking is larger in size (400 miles of fiber) than the county’s operational (Information Systems Services) fiber optic networking (278 miles). Examples of other jurisdictions that operate fiber optic networking for traffic management gathered from Appendices I and III include Pinellas County, City of Daytona Beach, City of Tallahassee, Broward County, Osceola County, and Martin County. In addition, Magellan Advisors identifies “Intelligent Traffic Systems” as a common application being supported on municipal fiber optic networks, along with “Red Light Cameras/Speed Cameras,” “Video Traffic/Route Surveillance,” and “Emergency Management.”

14.5.2 ITS Networking

Fiber optic communication technology supports ITS. Our review of facility maps indicates FDOT ITS has deployed from 24 to 96 fiber strands when implementing the network, depending on the location. To give an idea of comparative scale, FDOT currently operates 90,353 strand

³⁸³ Florida Department of Transportation, *Intelligent Transportation Systems Program Annual Report Fiscal Year 2009-2010*, 1.

³⁸⁴ *Ibid.*, 2.

³⁸⁵ *Ibid.*, 5, 21. VAS Phase I disseminated still images.

³⁸⁶ Florida Department of Transportation, *Intelligent Transportation Systems Program Annual Report Fiscal Year 2009-2010*, 21. The vendor selected plans to use Qwest data circuits obtained outside MFN if the ITS Wide Area Network is not available as needed. Interview by David Brevitz and Herb Cash, Public Utility Research Center, University of Florida, with Elizabeth Birriel, ITS Program Manager, Florida Department of Transportation; Randy Pierce, Telecommunications Program Manager, Florida Department of Transportation; and Frank Deasy, Program Manager and General Telecommunications Consultant, Florida Department of Transportation; November 30, 2010.

miles of fiber optic cable (which does not include County ITS facilities), while in contrast, FLR operates 3,080 strand miles (1,540 miles times two strands, which does not include member or affiliate local access connections). Strand miles are the number of fiber optic strands in a network segment times the number of route miles in that segment, calculated for each segment and then summed. Table 14-2 provides a summary.

Table 14-2. FDOT ITS Existing and Programmed Fiber Strand Miles, 2010

FDOT	Fiber Optic Cable Strand Miles	
	Existing	Programmed
	5,002	11,184
District 2	6,307	3,809
District 3	None	None
District 4	6,192	12,595
District 5	15,209	1,267
District 6	5,069	67
District 7	11,294	216
Turnpike	41,280	-
Total	90,353	29,138

Source: FDOT.

14.5.3 “Highway Purposes” Policy Requirement and Implications

The ITS fiber optic communications networking is discussed separately from other Florida broadband networks for two reasons. First, ITS is designed for a specific purpose—traffic management—and therefore has the characteristics more of a cabling plan than full-blown communications networking. This conclusion is drawn from review of facility maps provided by FDOT,³⁸⁷ which show that the ITS networking does not have a ring or other topology that is characteristic of communications networks. However, FDOT is using ITS facilities to develop WAN capabilities for its internal use, and to support the Video Aggregation System.³⁸⁸ The

³⁸⁷ These facility maps are not considered to be “public records,” and were reviewed under a commitment to not disclose or release the facility maps but to only view them for purposes of this project. FDOT states the facility maps are considered confidential and released on a “need to know” basis only and shall not be disclosed and/or released under Florida Statute F.S. 119.071(3).

³⁸⁸ Interview by David Brevitz and Herb Cash, Public Utility Research Center, University of Florida, with Elizabeth Birriel, ITS Program Manager, Florida Department of Transportation; Randy Pierce, Telecommunications Program Manager, Florida Department of Transportation; and Frank Deasy, Program Manager and General Telecommunications Consultant, Florida Department of Transportation; November 30, 2010.

extent to which FDOT ITS is able to take advantage of new technology that continually increases the information transport capabilities of fiber optic infrastructure (e.g., DWDM) was not clear from our research. Being able to increase information transport capabilities of fiber plays a very important role cost performance role of modern networks. Second and relatedly, we learned during the course of this study that absent a waiver from the Federal Highway Administrator, the fiber optic facilities and assets funded by ITS cannot be used for other uses beyond transportation traffic management purposes. The federal statutes cited by the Department of Transportation as restricting use of ITS facilities to “highway purposes” and provide provision for waiver are as follows.³⁸⁹

U.S.C. Title 23, Section 1.23(b) *Use for highway purposes*. Except as provided under paragraph (c) of this section, all real property, including air space, within the right-of-way boundaries of a project shall be devoted exclusively to public highway purposes.

U.S.C. Title 23, Section 1.23 (c) *Other use or occupancy*. Subject to 23 U.S.C. 111, the temporary or permanent occupancy or use of right-of-way, including air space, for non-highway purposes and the reservation of subsurface mineral rights within the boundaries of the rights-of-way of federal-aid highways, may be approved by the Administrator, if he determines that such occupancy, use or reservation is in the public interest and will not impair the highway or interfere with the free and safe flow of traffic thereon.

Policies and practices of FDOT were identified during this study by a number of stakeholders as significant barriers to cost-effective use of fiber optic network facilities for ITS, including cities and counties (for example, see Magellan Advisors Appendices I and II) and discussion of this subject in the Service Providers Forum.³⁹⁰ There is widespread interest among local jurisdictions, DMS and FLR in leveraging FDOT fiber optic capacity to the extent allowable. As described above, use of ITS communications networking is, in the absence of a waiver, restricted to “highway purposes” by federal statute under which the federal funds are provided to construct the ITS.

We note that FDOT currently has a project underway to develop a system that will provide information from which utilization can be determined. The new system will provide an accessible facilities management database (“Intelligent Transportation Systems Facilities

³⁸⁹ Questions about interpretation or applicability of these or other provisions of Florida or federal law should be directed to competent legal counsel.

³⁹⁰ DMS also sees these policies and practices as making any underutilized capacity which might exist “unavailable to SUNCOM or for other government purposes.” Department of Management Services, *Division of Telecommunications Business Model*, 54.

Management”) which will enable “compil[ing] network asset information into a single, graphical and tabular database so the Districts and Central Office can manage the entire system.”³⁹¹

We recommend that consideration should be given to seeking a waiver from the Federal Highway Administration to permit more widespread use of ITS fiber optic cable where “unused bandwidth” might exist. The first task will be to compile information regarding the number of strands that have been deployed for the desired segment(s) of the network, the number of strands which are currently utilized in the segment(s), and the number of strands which FDOT intends to utilize or “light” during the next 3-5 years.

When this information is compiled, it would then need to be evaluated in light of the following factors:

- FDOT future plans
- Potential impact on future FDOT funding requests if facilities previously placed are made available for non-highway use
- Condition of the fiber strands, i.e., is there a large number that have been damaged by fiber cuts such that they may need to be replaced, or replaced with other strands
- Technology and cost of upgrade, i.e., can additional bandwidth be derived by changing electronics on the fibers, and, if so, what would be the estimated costs and who would pay them
- Cost to develop and manage a resource sharing program.

Similar consideration and analysis would need to be given to conduit structures.

³⁹¹ Florida Department of Transportation, *Intelligent Transportation Systems Program Annual Report Fiscal Year 2009-2010*, 30-31. This is a very significant undertaking involving detailed review and entry of information, which will take several years to accomplish. Interview by David Brevitz and Herb Cash, Public Utility Research Center, University of Florida, with Elizabeth Birriel, ITS Program Manager, Florida Department of Transportation; Randy Pierce, Telecommunications Program Manager, Florida Department of Transportation; and Frank Deasy, Program Manager and General Telecommunications Consultant, Florida Department of Transportation; November 30, 2010.

14.6 New Networks Funded by American Recovery and Reinvestment Act

14.6.1 North Florida Broadband Authority (NFBA) and Florida Rural Broadband Alliance (FRBA)³⁹²

The North Florida Broadband Authority (NFBA), a new entity created on August 7, 2009 by interlocal agreement under Chapter 163 of the Florida Statutes among 15 counties and eight cities,³⁹³ intends to provide “middle mile access to broadband internet services for both last mile service providers and public institutions in underserved areas of Northern Florida.”³⁹⁴ This 14-county RACEC (plus Wakulla County),³⁹⁵ which will be served by the Authority, is the largest of three RACECs in Florida. The RACEC designation stems from the “challenges faced in creating job growth, attracting new businesses, and enhancing economic opportunities in the region.”³⁹⁶

NFBA is to link Internet backbone facilities to anchor institutions, businesses and consumers in the region. NFBA is intended to create wholesale Internet access capacity, in a region where such access is currently limited. The Florida Rural Broadband Alliance (FRBA) is composed of two RACECs, South Central Florida and Northwest Florida,³⁹⁷ and is similar in objective to NFBA. NFBA and FRBA are both regional networks being created with funds provided under the American Recovery and Reinvestment Act (ARRA).

Both NFBA and FRBA will own the network, but plan to outsource most network management and back-office functions. FRBA shares common management and engineering resources with NFBA. NFBA and FRBA business plans rely on providing service to state agency or organization locations that are currently served by or eligible to be served by MFN. Subscriber estimates in the NFBA financial projections indicate that 369 of 645 total public sector

³⁹² Review of this section was requested January 11, 2011 and timely received from Jeff Hendry in time for final publication of this report. We appreciate and acknowledge the review of this section provided by Jeff Hendry on behalf of NFBA and FRBA.

³⁹³ North Florida Broadband Authority, *North Florida Broadband Authority Interim Business Plan*, 2; North Florida Economic Development Partnership, *North Florida Rural Area of Critical Economic Concern Broadband Feasibility Study*, page 1.

³⁹⁴ *Ibid.*

³⁹⁵ The 15 counties are Columbia, Baker, Bradford, Dixie, Gilchrist, Hamilton, Jefferson, Lafayette, Levy, Madison, Putnam, Suwannee, Taylor, Union and Wakulla.

³⁹⁶ North Florida Broadband Authority, *North Florida Broadband Authority Interim Business Plan*, 2.

³⁹⁷ The South Central RACEC is known as Florida’s Heartland Rural Economic Development Initiative or FHREDI, and is composed of DeSoto, Glades, Hardee, Hendry, Highlands and Okeechobee counties as well as the unincorporated areas of Immokalee in Collier County and Seminole tribal lands. The Northwest RACEC is known as Opportunity Florida and includes Calhoun, Franklin, Gadsden, Gulf, Holmes, Jackson, Liberty and Washington Counties.

subscribers in the market are current MFN customers. The financial projections indicate that NFBA estimates it will serve 308 of the public sector entities, or approximately half. The focus on MFN is indicated by the “Target Strategic Institutions (MYFLN Connections)” included as Appendix F.³⁹⁸ Business and technical arrangements to use NFBA and FRBA for MFN access are being explored by the parties.³⁹⁹

NFBA does not have taxing authority, but is permitted to issue bonds. FRBA is similarly created.⁴⁰⁰

The key network components of the planned network are microwave ring topology and microwave point-to-point links to the last mile provider or anchor tenant premise.⁴⁰¹ Routing and switching devices will be located at the tower sites, creating a uniform Aggregation Node feature-dense topology. Therefore the tower site is capable of delivering a wide variety of features including security, smarter traffic management, maintenance and troubleshooting, and billing verification.⁴⁰² The network design will use as many city, county and state tower/rooftop assets as possible to avoid unnecessary monthly recurring charges.⁴⁰³ The network will provide minimum available bandwidth of 100Mbps, and the customer may select smaller increments of 10Mbps.

³⁹⁸ North Florida Economic Development Partnership, *North Florida Rural Area of Critical Economic Concern*, Figure 18 and Appendix F.

³⁹⁹ Interview by David Brevitz, Herb Cash and Mark Jamison, Public Utility Research Center, University of Florida with Pat Lien, Walt Henley, Jeff Hendry, Lazaro Sanchez, Russ Anderson, and Dustin Jurman of North Florida Broadband Authority, August 31, 2010. Meeting of NFBA and DMS staff, September 24, 2010.

⁴⁰⁰ Interview by David Brevitz, Herb Cash and Mark Jamison, Public Utility Research Center, University of Florida with Pat Lien, Walt Henley, Jeff Hendry, Lazaro Sanchez, Russ Anderson, and Dustin Jurman of North Florida Broadband Authority, August 31, 2010.

⁴⁰¹ North Florida Broadband Authority, *North Florida Broadband Authority Interim Business Plan*, 14; Interview by David Brevitz, Herb Cash and Mark Jamison, Public Utility Research Center, University of Florida with Pat Lien, Walt Henley, Jeff Hendry, Lazaro Sanchez, Russ Anderson, and Dustin Jurman of North Florida Broadband Authority, August 31, 2010.

⁴⁰² North Florida Broadband Authority, *North Florida Broadband Authority Interim Business Plan*, 19.

⁴⁰³ *Ibid.*

15 Networks Operated by Florida Local Units of Government

Here, we provide a more detailed context for our financial analysis and our policy recommendations regarding centralization, governance and cost performance monitoring in Volume 1.

15.1 Florida Law Impacting Municipal Networks

One constitutional provision and two statutes governing municipal telecommunication services have been referenced during discussions related to the DMS broadband planning effort. Article VIII, Section 2(b) of the Florida Constitution establishes municipal home rule and Sections 166.047 and 350.81 of the Florida Statutes address telecommunication services provided by municipalities or other governmental entities.⁴⁰⁴

15.1.1 Municipal Home Rule

Article VIII, Section 2(b), of the Florida Constitution establishes the framework for municipal home rule:

Municipalities shall have governmental, corporate and proprietary powers to enable them to conduct municipal government, perform municipal functions and render municipal services, and may exercise any power for municipal purposes except as otherwise provided by law...

According to an explanation of the constitutional provision in the *Florida Municipal Officials' Manual* published by the Florida League of Cities, “before [the Constitution was amended in] 1969, a municipality could do only those things which it was **clearly authorized** to do . . .; after 1969, a municipality may do **anything** which it is **not prohibited** from doing.” (emphasis in original)⁴⁰⁵

Statutes relating to municipal home rule are codified at Chapter 166 of the Florida Statutes, the Municipal Home Rule Powers Act, enacted in 1973. The Act includes a definition of the phrase “municipal purposes” that is used, but not defined, in the Constitution. By law, those purposes are “any activity or power which may be exercised by the state or its political subdivisions.”⁴⁰⁶

Also, as described in the League of Cities publication, “in decisions since 1973, the Supreme Court has consistently respected the home-rule principle. . . . The Legislature is ultimately

⁴⁰⁴ Provisions of Florida law are summarized here for ease of reference. Questions about interpretation or applicability of these or other provisions of Florida law should be directed to competent legal counsel. Statutes cited were accessed at <http://www.leg.state.fl.us/statutes/>. Session laws, Laws of Florida, cited were accessed at <http://laws.flrules.org/>, accessed September 2010.

⁴⁰⁵ Florida League of Cities, *Municipal Officials' Manual*, 8.

⁴⁰⁶ Section 166.021(2), Florida Statutes.

supreme, still, in that it may restrict the powers of municipal self-government by erecting specific prohibitions. Absent such prohibitions, however, municipal officials may exercise any power, so long as it be for a municipal purpose.”⁴⁰⁷

15.1.2 Provision of Telecommunications Services by Municipalities or Other Entities of Local Government

Section 166.047 of the Florida Statutes addresses telecommunication services provided by municipalities or other entities of local government. The section authorizes those telecommunications companies to obtain or hold a certificate pursuant to Chapter 364, Florida Statutes. Obtaining such a certificate is specifically designated as serving a municipal or public purpose under conditions enumerated in the statute. Those conditions include separate accounting for revenue and expenses associated with the services; imposition of the same local regulations on the municipal companies as are applied to other telecommunication companies; and payment of ad valorem taxes.

15.1.3 Procedures and Operating Conditions for Governmental Entities Providing Cable or Telecommunications Services

Section 350.81 of the Florida Statutes creates procedures and certain operating conditions for governmental entities that propose to provide, or do provide, cable or telecommunication service, including wireless.⁴⁰⁸ The statute defines “governmental entity” as a “county, municipality, special district, school district, utility authority or other authority or any instrumentality, agency, unit or department thereof.”⁴⁰⁹ The statutory procedures apply to governmental entities that provide, or propose to provide, the services for a fee or other consideration to entities other than itself. The services cannot be subsidized by other revenue to make price of the service below the cost. The governmental unit offering the service must maintain separate books and records, operating and capital budgets, and an enterprise fund for operation of the service. A governmental unit may not use its power of eminent domain solely or primarily to provide a communication service. Governmental entities are authorized under conditions established by the statute to issue revenue bonds to finance capital costs for the service. Bonds issues for that purpose, and that do not mature within 15 years, must be approved by the voters. Governmental entities providing communications services under this statute also are subject to applicable federal and state laws and regulations, and local ordinances, rules and policy that apply to other entities providing such services.

A governmental entity that proposes to provide a communication service for a fee other than to itself must conduct a minimum of two public hearings at least 30 days apart. At a public hearing

⁴⁰⁷ Florida League of Cities, *Municipal Officials’ Manual*, 8.

⁴⁰⁸ Specific definitions of those services are at Section 350.81(1).

⁴⁰⁹ Section 350.81(1)(e), Florida Statutes.

held pursuant to the statute, the governmental entity is required to consider at least the following:

- Whether the proposed service, or a similar service, is currently being offered in the community and, if so, whether the service is generally available throughout the community;
- If the same or a similar service is not currently offered, whether any other service provider proposes to offer the same or similar service, and if so, what assurances that provider is willing or able to offer regarding the service;
- The required capital investment by the governmental entity to provide the proposed service, the estimated cost of operation and maintenance and, using a full cost-accounting method, the estimated revenue and expense of providing the service and the proposed financing method; and
- The private and public costs and benefits of providing the service, including the impact on jobs, economic development, the tax base, education and public health.

The governmental entity proposing the services must make available to the public at one or more of the public hearings, a written business plan for the proposed service. That business plan must include, at a minimum:

- The projected number of subscribers;
- The area to be served;
- The types of services that will be offered;
- A plan to ensure that revenues exceed operating expenses and payment of principal and interest on debt within 4 years;
- An estimate of capital and operational costs and revenue for the first 4 years; and
- A plan for network modernization and technological upgrades, including cost estimates.

An annual hearing must be conducted by the governmental entity for the purpose of considering the progress being made toward reaching the business plan goals and objectives for the service. If, after 4 years, revenues from the service do not exceed expenses and payment of principal and interest on any debt, the governmental entity is required to hold a public hearing at which it:

- Approves a plan to quit providing the service which may include disposing of the system used to provide the service;
- Approves a plan to create a partnership with a private entity in order to realize the required revenue; or
- Approve, by a majority vote of the governing body, continuation of the service.

15.2 Summary of Findings

Our research and analysis show that numerous cities and counties have deployed and are operating fiber optic and wireless broadband networks to meet communications networking needs between locations. Among our major findings is the extent of networking that has been developed by local units of government and regional organizations.⁴¹⁰ According to a survey by Magellan Advisors, the focus is to save money via quick paybacks and efficient deployment.

Local officials believe their government broadband networks foster and support economic development. The City of Palm Coast provides one example:

The economic development benefits of Palm Coast's FiberNET network are only just beginning to show. The City has been able to attract new business to Palm Coast through its aggressive economic development initiatives, which include advanced local broadband. The City's largest employer made the decision to relocate its headquarters to Palm Coast in part due to direct fiber access into its facility. An Internet-intensive business, the company needed high-speed, stable and redundant Internet connectivity. FiberNET provided the needed capacity directly to the company as part of the deal for relocation to the Palm Coast area. The City doubled the size of its largest employer and brought an additional 1,000 jobs to the area.⁴¹¹

Collaboration between local jurisdictions (both between counties and municipalities, and between city/county ITS and cities and counties) appears to be increasing in frequency and expanding to encompass shared collaborative use of communications networks and ITS/traffic management facilities. Cost savings and benefits are discussed in the South Florida Shared Fiber Initiative Position Paper.

15.3 Summary of City and County Broadband Networking

Knowledge of city and county broadband networking can be gained from documents provided by cities and counties, as well as Local Broadband Inventory survey work done in 2009 and 2010. The 2009 survey was developed and conducted by DMS in summer 2009, in which it surveyed Florida cities and counties regarding broadband network inventory. The 2010 survey was conducted by Magellan Advisors under the Public Utility Research Center (PURC) auspices to extend and update the 2009 DMS survey. Magellan Advisors conducted the survey online. The 2010 survey asked the same questions as the 2009 survey to maintain continuity, and added additional questions, shown in Appendix I.

⁴¹⁰ Magellan Advisors, LLC, *Local Government Communications Use*, Appendix II.

⁴¹¹ Ibid.

Sixty-nine cities responded to the 2009 survey, and 16 additional cities responded to the 2010 survey. In addition, 16 cities who responded in 2009 also responded in 2010. Compilation of actual survey results for selected questions by city and county is provided in Appendix I.

It can be seen from survey information in Appendix I, and Magellan Advisors (Appendix II) that:

- Cities and counties use a mix of sourcing methods for communications networking, including owned facilities, facilities leased from carriers or other operators, fiber optic and wireless broadband facilities, MFN service from DMS, and collaborative-sharing arrangements with other jurisdictions. There does not appear to be any jurisdiction that is a “pure play” on any single item in the mix of methods except for cities or counties that rely entirely on commercial providers for their networking.
- At least 33 cities⁴¹² own and operate their own fiber optic network for internal data communications via MAN and/or point to point connections between buildings, agencies and other locations, and additional cities⁴¹³ are considering operating MAN networking or point-to-point facilities.
- At least 36 cities and 3 counties indicated they do not, and do not intend to operate a MAN or point to point fiber facilities. However, some of the jurisdictions later chose to become participants in the North Florida Broadband Authority and FRBA regional wireless network initiatives.
- A number of counties own and operate their own fiber optic network for internal data communications via MAN and/or point-to-point connections between buildings, agencies and other locations.
- Cities and counties use the fiber networking to provide service to schools and universities.
- At least five cities and two counties use dark or leased fiber from commercial carriers.
- A number of cities and counties are using wireless service as back-up connections, or for replacement of other carriers or for point to point connections.
- A number of cities are using broadband facilities from MFN.⁴¹⁴

A number of jurisdictions that interconnect and/or collaborate with facilities sharing and/or joint planning:

⁴¹² Bartow, Daytona Beach, Gainesville, Haines City, Highlands, Lakeland, Ocala, Palm Coast, Vero Beach, Atlantic Beach; Cocoa; Indian Harbor; Key West; Leesburg; Lighthouse; Longwood; Margate; Milton; Mount Dora; Ormond; Oviedo; Palm Bay; Punta Gorda; St. Augustine; Tampa, City of Fernandina Beach; City of Largo; City of Ocoee; City of Ormond Beach; City of Wilton Manors; City of Winter Garden; and City of West Melbourne.

⁴¹³ Cocoa, Jupiter, Leesburg, Palm Bay, Rockledge; and Sarasota.

⁴¹⁴ DMS billing and account records show that many more cities and counties use MFN than indicated by the survey results.

- Bartow and Lakeland
- Vero Beach and Indian River County
- Palm Coast and Flagler County
- Polk County and City of Bartow
- Osceola County, Osceola County Sheriff, and Kissimmee Utility Authority
- Marion County ITS and Ocala Electric Utility
- Osceola County, Florida Turnpike Authority, City of St. Cloud
- Palm Beach County and City of Jupiter
- Palm Beach County delivery of FLR services to municipalities within the County⁴¹⁵
- South Florida Shared Fiber Initiative, including Miami Dade County
- Seminole County Sheriff’s office and seven municipal police departments, sharing Computer Aided Dispatch and Records Management System⁴¹⁶
- Seminole County, FDOT and neighboring counties⁴¹⁷
- City of Leesburg and School Board sites including schools and administration buildings⁴¹⁸

We know of no instances where local authorities approached DMS to collaborate in the provision of access for MFN users to the MFN network.

15.4 South Florida Shared Fiber Initiative (SFSFI)

A recent project planned by five South Florida counties and the Fort Pierce Utilities Authority was designed to meet the need for broadband-based applications in their communities. South Florida Shared Fiber Initiative (SFSFI) applied for funding through the Broadband Technology Opportunities Program. The project was not funded through the Broadband Technology Opportunities Program (BTOP).

The entities involved in the SFSFI are located in FDOT District 4. In mid-2010, SFSFI requested the ability to utilize fiber optic cable facilities controlled by FDOT. As described in a Position Paper with supporting information provided to FDOT with that request, the purpose of the initiative is to enable use of FDOT fiber networks, for both traffic control and other governmental purposes.⁴¹⁹ According to the participants in the project, local units of government in Florida are prohibited by federal regulation from using the FDOT ITS facilities for any purpose other than traffic control; however, federal regulations also provide provision for waiver,

⁴¹⁵ Magellan Advisors, LLC, *Local Government Communications Use*, Appendix II.

⁴¹⁶ Magellan Advisors, LLC, *Local Government Communications Use*, Appendix II.

⁴¹⁷ Ibid.

⁴¹⁸ Ibid.

⁴¹⁹ South Florida Shared Fiber Initiative, “Position Paper.”

as noted above in the description of FDOT ITS networking. DMS worked with this group and others in an attempt to facilitate leveraging of FDOT ITS assets and facilities. Participants in the initiative requested that FDOT seek a waiver of the federal regulation.

16 Comparison of State Networks

Next, we provide a more detailed context for our policy recommendations in Volume 1.

Among other tasks, this project undertakes “a comparison of other broadband systems for states of similar size as Florida.”⁴²⁰ This comparison provides information regarding how other states are addressing the subject of broadband planning for government use and how broadband networking has developed given potentially different governance approaches.⁴²¹ Details concerning state approaches provide the necessary context for our recommendations concerning the need for enterprise strategic planning, governance, and e-Rate support in Volume 1. As requested by DMS, PURC and DMS staff identified four states based on population size for this comparison: Illinois, New York, Ohio, and Pennsylvania.⁴²² The five states range from the third to the seventh largest in the nation.

We gathered information about those states’ networks from publicly available documentation. During the course of this review, we identified an overarching issue that called for discussion in addition to the functional descriptions of the state networks: the governance and planning approaches used in these states for information technology (IT). This section provides a description of Florida’s broadband networks; compares those networks to networks in the four other states; and includes descriptions of the governance of those networks. A summary of Florida’s statutes is found in Sections 14.1 (state networks), 15.1 (Municipal networks) and 19.1 (Public Safety).

A portion of the effort to compare the five networks involved an analysis of the technical elements of each of the networks. A matrix displaying the result of that analysis is in Appendix VII of this volume. In light of the differences in architecture, engineering, financing and procurement practices of the states examined, we conclude that the physical networks and services arrangements are very different and for that reason, the cost information included in this volume as Appendix VIII also does not yield meaningful comparison. In other words without very detailed technical analysis, the pricing information is “apples and oranges.”

In the five states examined, state government agencies are provided with networks that are centrally operated by a state agency, or network services that are procured through a statewide

⁴²⁰ Department of Management Services, *Request for Quotes, State Broadband Planning Initiative*.

⁴²¹ Each of the four other states’ networks was compared in this analysis to relevant networks in Florida. The four other states were not compared to each other.

⁴²² New York is the largest, with a population of 19,541,453 persons. Florida is next largest with a population of 18,537,969. Illinois, Pennsylvania, and Ohio have populations of 12,910,409, 12,604,767, and 11,542,645, respectively. Population numbers are for July 1, 2009. Source: Table 1. Annual Estimates of the Resident Population for the U.S., Regions, States, and Puerto Rico: April 1, 2000 to July 1, 2009 (NST-EST2009-01), U.S. Census Bureau, Population Division. Release Date: December 2009.

contract or contracts, or that are available through a combination of centralized procurement and operation. None of the states has a completely decentralized approach to providing network services to their respective agencies. Neither do any of the states examined have a completely unified “single state network” that meets the needs of all functional areas of state and local government. All of the states examined utilize a mix of owned and leased facilities to provision their networks.

Agencies of the executive branches of the states typically are required to use a state network by law or by executive order.⁴²³ All of the states examined point to the efforts of the network management agency to contain costs and to capitalize on certain economies of scale that result from the scope of service offerings necessary for state government operation. Public universities are frequently an exception to a uniform data network rule, where such a rule exists, as they are in Florida. So, some institutions of higher education participate in private research and education networks in lieu of or in addition to any state network. (See discussion of Higher Education networks in Section 17.) In all four states, separate data networks exist for law enforcement/public safety agencies. (See discussion of Public Safety networks in Section 19.)

16.1 Scope and Role of Networks

Florida: State agencies are required under Florida law (Chapter 282 of the Florida Statutes summarized in volume 1 of this report) to utilize SUNCOM/MFN services unless exempted by DMS from the requirement or exempt by law. The legislative and judicial branches are permitted to use SUNCOM/MFN, as are local authorities and non-profit organizations. The current geographical footprint of MFN is statewide. According to DMS, SUNCOM is to provide “superior telecommunications services more cost-effectively to state and local governments, educational institutions, libraries, and non-profit organizations by achieving economies of scale with enterprise planning and procurement.”⁴²⁴

MFN services provided to SUNCOM-eligible entities support critical government applications. To illustrate these applications, information displayed in the table in Appendix V was extracted from submissions to the Florida TRW from state agencies. The information was collected by TRW in preparation for its recommendations for the Funding Year (FY) 2010-2011 budget. (See Section 20.4 of this volume for a description of TRW’s responsibilities.)⁴²⁵ The table contains

⁴²³ Florida: Sections 282.701-282.711, Florida Statutes; Illinois: 20 ILCS 405/405-270; State of Ohio, *Establishing the Ohio Broadband Council*, 6a-b.; Commonwealth of Pennsylvania, *Enterprise Information Technology Governance Board*.

⁴²⁴ Department of Management Services, “SUNCOM Products and Pricing.”

⁴²⁵ All agencies, except the Northwood and Southwood Shared Resource Centers, Florida Parole Commission, Statewide Guardian Ad Litem Office, Clerks of Court Operations Corporation, State Attorneys, Public Defenders, Guardians Ad Litem, Capital Collateral Regions, and Criminal Conflict and Civil Regional Counsels, are required to submit the entire Schedule IV-C for the non-strategic and strategic IT services to the Technology Review

descriptions of the impact on state agencies of loss of network services. The summaries make clear the degree to which state agencies depend upon broadband networking to accomplish routine tasks. As described by the agencies, for those with offices throughout the state, the absence of network support would make day-to-day transactions with other agencies and offices statewide more complex and time-consuming. For law enforcement and public safety agencies, the impact would be great because of the large number of personnel who are not at fixed locations, and because rapid access to criminal records and related information is impossible without IT applications.

Illinois: The Illinois Century Network (ICN) authorizing legislation requires the network to provide access to state agencies, but does not impose requirements for agencies to utilize the network. The Department of Central Management Services is authorized by statute to “provide for and coordinate communications services for state agencies and, when requested and when in the best interests of the state, for units of federal or local governments and public and not for profit institutions of primary, secondary, and higher education.”⁴²⁶

New York: State agency participation in the OneNetNY network is optional, but all state agencies, are connected to NYeNET, the New York state backbone. For the state university system (SUNY) and city university system, NYeNET is only used for administrative functions.

Ohio: All Executive Branch agencies utilize the state network in Ohio. The Legislative and Judicial Branches are specifically not required to utilize the state network and telecommunications contract, respectively. However, the Legislature and the Supreme Court of Ohio are connected to the state backbone network and purchase from the Infrastructure Division both Internet and intranet access. That relationship is authorized in statute.⁴²⁷

Pennsylvania: The legislative and judicial branches are specifically not required to utilize the telecommunications contract. In regard to telecommunications, the Office of Information Technology is directed to coordinate the Commonwealth’s telecommunication policy and technical infrastructure regarding Commonwealth’s education, economic development, residential, and commercial communities.⁴²⁸

Workgroup.

⁴²⁶ 20 ILCS 405/405-270. <http://ilga.gov/legislation/ilcs/ilcs5.asp?ActID=235&ChapterID=5>, accessed November 18, 2010.

⁴²⁷ ORC 125.18 (F) provides that “With the approval of the director of administrative services, the office of information technology **may establish cooperative agreements with federal and local government agencies and state agencies that are not under the authority of the governor for the provision of technology services and the development of technology projects.**” (emphasis added). <http://codes.ohio.gov/orc/125>, accessed September 15, 2010.

⁴²⁸ Agency for Enterprise Information Technology, “Data Center Consolidation.”

16.2 Evolution of Networks

Each state’s data networking has a unique history that is reflected in its current configuration. Because of the uniqueness of each state’s history and policy framework, it would be unrealistic to try to adopt another state’s strategic plan for Florida. In order to help the reader better understand the networks, we provide a summary history of each state’s evolution below:

Florida: MFN is a broadband network service provided to state agencies, local governments, and certain nonprofit organizations as part of the SUNCOM portfolio of services. SUNCOM was established in 1973 to provide cost-effective voice communications services to state agencies.⁴²⁹ Prior to that time, state agencies had purchased telecommunications services at commercial rates from one of 24 local telephone companies operating in Florida and serving the agencies’ locations. According to the DMS draft strategic telecommunications plan, “this all changed when a group of engineers from Cape Canaveral offered to help the state by developing contracts for voice services. Through this concept, they were able to leverage the buying power of the state and reduce costs for telecommunications services through volume purchasing.”⁴³⁰ In 1986, the Florida High Technology and Industry Council, under the auspices of the Governor’s Office, produced a “Needs Assessment for an Integrated Backbone Statewide Communications Network for the State of Florida.” Among the assessment’s findings was the need for a high capacity backbone transport facility based on fiber optic technology.

As described in the 2006 SUNCOM services portfolio:

In 1986 SUNCOM expanded from a five-node analog switch network to an eleven-node digital network. In 1987 with the addition of T1 digital backbone facilities, SUNCOM began migration to the fully integrated network that exists today, providing local and long distance voice communications, and the common backbone for transport of data communications, as well as video and radio control signals.

In general, networking infrastructures lack sufficient functionality or robustness to meet requirements of increasingly networked applications critical in today’s workplace. As a solution, the Department of Management Services, through the teamwork of the Enterprise Information Technology Services program and State Purchasing, is designing and procuring the next phase of SUNCOM communications services, *MyFloridaNet*.

Under *MyFloridaNet*, local service providers will utilize their infrastructures to maximize a potential for statewide communications access to all of Florida’s

⁴²⁹ Ghini, *Strategic Plan 2009-2014*.

⁴³⁰ Ghini, *Strategic Plan 2009-2014*, 4.

constituents, including state and non-state facilities. Using a design goal of highly available, robust services, the state will establish a scalable networking platform capable of handling the ever increasing communications requirements of eligible users. As a new multipurpose communications network, *MyFloridaNet* will replace certain existing data services. The result will be to eliminate the current best effort platform and its inherent duplication, management, and intercommunication problems.⁴³¹

The integrated network migrated to the MFN platform in April 2008. A GIS-based depiction of MFN served locations is shown in Figure 16-1 and also can be seen at <http://oscar.geoplan.ufl.edu/flexviewer/>⁴³² where the user can zoom in on particular locations or areas of interest.

Illinois: In the mid-1980s, the Illinois State Board of Education (ISBE) established basic network connections between the Regional Offices of Education and ISBE. During the subsequent five years, the network was broadened to include local schools. In 2003, Illinois began an effort to consolidate state agency data networks onto ICN. The effort was dubbed the “IT & Telecom Rationalization Program.”⁴³³ Prior to 2003, the state had three means of transmitting data. First, the ICN served elementary, secondary and higher educational institutions, libraries and museums for the purpose of delivering and receiving educational content. Second, most state agencies independently leased networks.

Third, some other state agencies transmitted voice and data traffic over separate networks. In an attempt to reduce expenditures for network services statewide, the Illinois Department of Central Management Services identified the ICN as having the potential to enable consolidation of state data traffic onto a single core backbone. During the course of two years, 1,600 data circuits were moved to ICN which was upgraded to accommodate the extra traffic and redesigned to increase redundancy.⁴³⁴ In 2006, the Department of Central Management services began a year-long process to assess the needs of ICN users and developed a strategic plan, *The Next Illinois Century Network: A Vision and Strategic Plan* published in May 2007.⁴³⁵ A portion of the migration plan included working with a variety of public entities to connect publicly owned fiber, where it is available, to the CMS installed fiber.⁴³⁶

⁴³¹ Department of Management Services, *MyFloridaSUNCOM Services, Portfolio*, 13.

⁴³² Go to “Map Contents,” “Broadband Infrastructure” and check the “My Florida Network” box.

⁴³³ Vajha, et al., *IT/Telecom Rationalization*.

⁴³⁴ Ibid.

⁴³⁵ Illinois Department of Central Management Services, *Next Illinois Century Network*.

⁴³⁶ State of Illinois, *Illinois Century Network Fiber Migration*.

Figure 16-1. MFN Served Locations

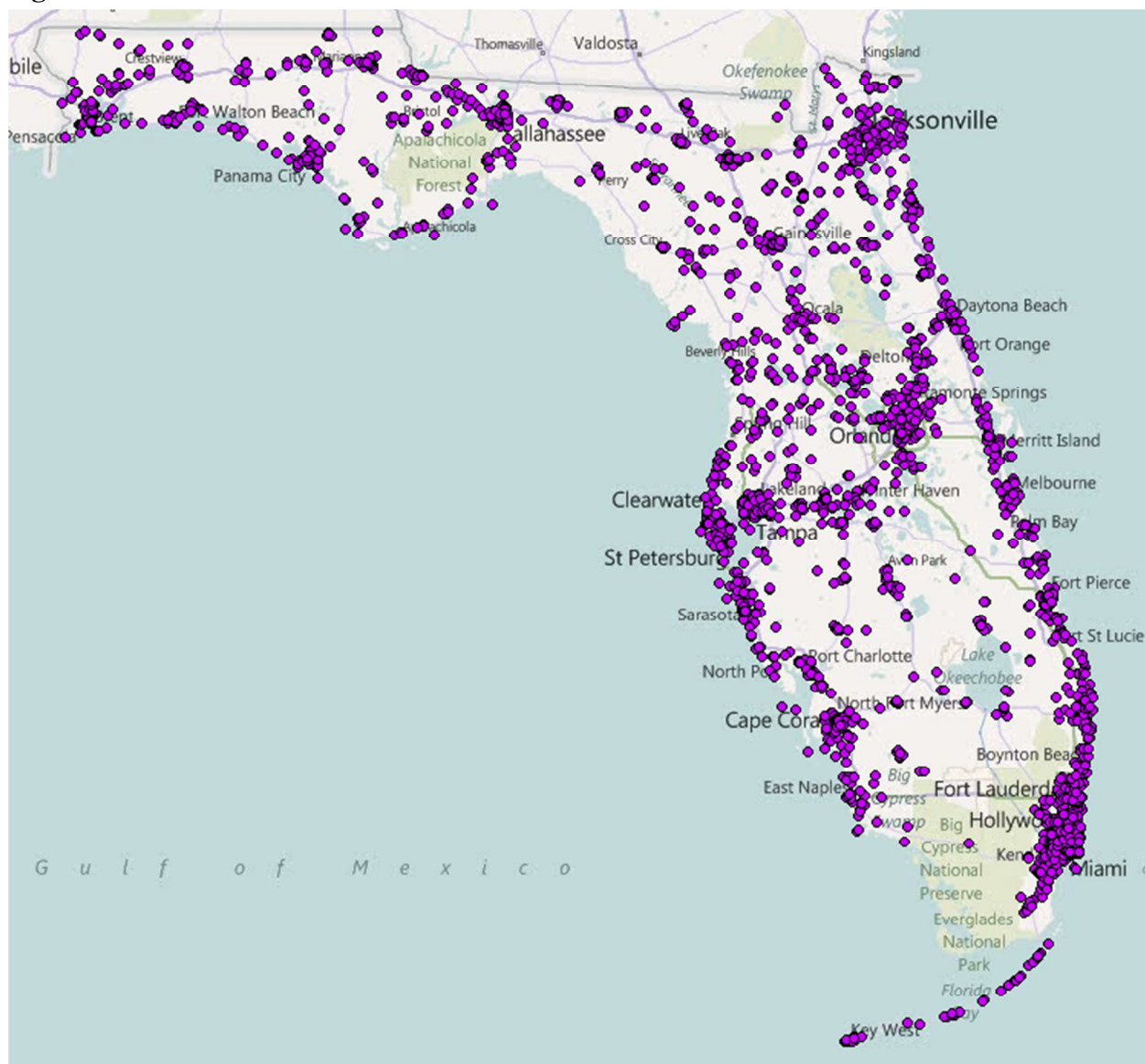

Source: University of Florida GeoPlan Center, <http://oscar.geoplan.ufl.edu/flexviewer/>.

As part of the Information Technology and Telecommunications Rationalization, Bureau of Communication and Computer Services (BCCS) centralized infrastructure functions previously devolved in certain agencies.⁴³⁷

New York: The primary technology service provider for the state is the CIO/Office for Technology (OFT). A history of OFT, as described in a recent request for proposals, follows:

⁴³⁷ Vajha, et al., *IT/Telecom Rationalization*.

The Office for Technology (OFT) was created in 1997, and functioned for several years solely as a policy-making body. Efforts to centralize technology operations began in 2000, with OFT assuming of responsibility for 16 separate data center operations as well as the Human Service Network. By 2002, OFT had added responsibility for state telecommunications, and the Division of Telecommunications was transferred from the Office of General Services.

Also in 2002, the Governor established the state Chief Information Officer and created the CIO Council to provide for statewide governance of technology issues. Over the next few years, the state's CIO Council emerged as a forum for policy discussions and the pursuit of statewide technology standards and projects. Through the CIO Council, relationships between the state and its local government partners were strengthened.

By 2005, OFT began to advocate for the creation of a single, centralized data center, to consolidate the existing four data centers as well as a majority of the state agency servers into a single location that would promote efficiencies. Although this effort languished for several years, it has recently gained significant momentum, as the state explores collaboration on a data center with three major New York universities.

Over the years, a practical merger of CIO and OFT has occurred in terms of leadership and missions. The Chief Information Officer directs the operations of both entities with a combined mission statement: "CIO/OFT will provide strategic technology leadership and deliver innovative IT solutions enabling New York government to improve the quality of life for our citizens, our businesses and our visitors."

In late 2007, CIO/OFT undertook further centralization of services, establishing a Shared Services unit for "back office" support operations. The agency also reduced its rates for selected IT Services, and initiated a performance management plan to baseline current service levels.

Currently CIO/OFT provides essential IT support services for 23 Agencies; operates four mainframe data centers, and the state telecommunications and data networks. In addition, CIO/OFT operates a help desk, and offers servers and storage, email and other infrastructure services. CIO/OFT also hosts approximately 42 missions-critical applications for various state agencies. Costs for virtually all services are billed to each agency based on rates set by OFT.

CIO/OFT has also established an initiative called "Plan 2010 – Going from Good to Great" which outlines the key strategies and goals to improve service, reduce

rates and advance technology priorities for the state enterprise.⁴³⁸

Ohio: OARNet is the state-owned fiber backbone. Its genesis is described on OARNet’s website:

The Ohio Academic Resources Network (OARnet) was created in 1987 by the Ohio Board of Regents, through legislation by the Ohio General Assembly [O.R.C., section 3333.04(V)]. OARnet was founded to provide Ohio researchers with their first “online” access to the high performance computing resources of the Ohio Supercomputer Center, established in Columbus earlier that same year.

Exponentially increasing demand from college and university researchers for statewide connectivity and increased bandwidth led to the acquisition of dark fiber to create a highly scalable, fiber-optic infrastructure, launched in November 2004. The new network was referred to as the Third Frontier Network and, later, OSCnet, both for a period when OARnet operated as the networking division of the Ohio Supercomputer Center.

Today, OARnet once more is functioning as an independent organization, and the network, again known as OARnet, consists of more than 1,850 miles of fiber-optic backbone. The network blankets the state, providing connectivity to Ohio’s colleges and universities, K-12 schools, public broadcasting stations, academic medical centers, and state, federal and partnering research organizations. The network also supports the collaborative IT initiatives of the Ohio Board of Regents: the Ohio Library and Information Network (OhioLINK), the Ohio Learning Network (OLN), and eTech-Ohio’s K-12 network.⁴³⁹

The state-owned Broadband Ohio Network⁴⁴⁰ resulted from the merger of Ohio.gov and OARNet, the network backbone for higher education. The Broadband Ohio Network initiative was spurred by Governor Strickland’s Executive Order 2007-24S.⁴⁴¹ A migration of state agencies to the OARNet backbone ensued but the vision of a fully integrated network was never realized due to funding shortfalls.

Pennsylvania: The Office of Administration, Office for Information Technology (OA/OIT) is the executive branch agency responsible for IT services in the Commonwealth. Those responsibilities were assigned to the OA/OIT pursuant to an Executive Order issued in 2004.

⁴³⁸ New York State, *Request for Proposals, IT Management Consulting Services*, 8-9.

⁴³⁹ “About OARNet.” <http://www.oar.net/about/index.shtml>, accessed September 21, 2010.

⁴⁴⁰ “About the Ohio Broadband Council,” <http://ohiobroadbandcouncil.org/network/index.shtml>, accessed September 21, 2010.

⁴⁴¹ State of Ohio, Executive Order 2007- 24S, *Establishing the Ohio Broadband Council*.

The Office implements the policy, planning, and budget directives of the Enterprise Information Technology Governance Board, also created by the Executive Order.⁴⁴²

Pennsylvania utilizes a central contract for provision of network services to state agencies and entities that participate in the state purchasing program. The only dedicated network infrastructure for general state agency use is located in the Harrisburg capital complex. The development of that network was described in a document prepared for the National Association of State Chief Information Officers (NASCIO) in 2010.

The Commonwealth of Pennsylvania has relied upon a single data provider since 1999. The technology provided by the incumbent is ATM-based, which was state-of-the-art at the time the contract was awarded. At more than 10 years old, however, the technology simply does not have enough flexibility to meet today's business needs.

Since the contract is in effect until 2011, the commonwealth has been locked into the ATM solution, dramatically limiting its ability to pursue technological advances. In addition to being locked into an antiquated solution, the commonwealth has been hampered by the incumbent's inability to easily increase bandwidth. Again—because of the network's age—the incumbent must often upgrade its own infrastructure to meet the commonwealth's bandwidth needs and only does so upon request.

In 2007 OA/OIT was awarded a \$7.8 million loan from the commonwealth's productivity bank—a special fund designed to help state government agencies make significant investments to achieve long-term savings and efficiencies. OA/OIT began to design and build its own fiber optic, a DWDM Ethernet solution to be used by agencies in the metropolitan Harrisburg area.

By developing a network owned by the commonwealth and dedicated solely to the meet the needs of the commonwealth, a number of operational frustrations would be eliminated for a wide array of state government agencies. Every agency would enjoy greater bandwidth (a minimum of 1 gig) and would be able to increase their use quickly and easily, as their business needs dictate.

There was significant potential lying dormant in extensive fiber optic cabling plant that was already in place throughout the capitol complex, being used primarily for CATV services. The plan was to build COPANET to key locations on the capitol complex and utilize the existing fiber plant to provide data services

⁴⁴² Commonwealth of Pennsylvania, *Enterprise Information Technology Governance Board*.

to additional buildings.

An 8-mile network was built in 2008. COPANET's architecture includes diverse fiber routing into each building while a continuous fiber run connects all buildings. Redundant nodes at each site assure greater than 99.999% reliability and availability.⁴⁴³

16.3 Outsourcing or State Ownership and Operation

Some differences in scope of services discussed earlier from the state's decision regarding how much of the network it will own and operate "in house" or whether facilities will be leased or services obtained via contract. None of the states we examined has completely "outsourced" all network operation and management responsibilities. Likewise, all of the states utilize a mix of state ownership, leasing of infrastructure, and contracting for services to create and operate their networks.

Florida: MFN is procured under contract from AT&T as the prime contractor. AT&T has subcontracts for particular functions (e.g., Network Operations Center from CenturyLink) and geographical areas (e.g., other territories served by providers such as CenturyLink and Verizon).

Illinois: BCCS provides network connectivity to state agencies as a fully managed service.⁴⁴⁴ "BCCS operations are similar to those of a telephone company. Using an optimal mixture of state and vendor services, BCCS offers a variety of telecommunications products and services through a statewide network comprised of thousands of miles of voice and data lines, fiber and copper cable, and Voice over Internet Protocol serving more than 130,000 employees of the State of Illinois. Negotiated contracts provide a broad product mix at competitive rates to serve the business needs of the state."⁴⁴⁵

New York: The network that serves New York state agencies is state-owned and operated by NYeNET as a statewide end-to-end network. In addition to NYeNET, the Office for Technology provides Customer Networking Solutions—a composite of centralized, managed networking services, including network operating services, LAN and WAN maintenance and support, and Internet access and endpoint security to ensure safe and secure connections to the NYeNet, CIO/OFT Statewide Data Centers and state agencies.⁴⁴⁶

Ohio: The state network uses a variety of services purchased from third-party vendors.

⁴⁴³ Commonwealth of Pennsylvania, *2010 NASCIO Awards, Improving State Operations, COPANET*.

⁴⁴⁴ State of Illinois, *Customer Service Center: A Telecom Coordinator Guide*.

⁴⁴⁵ State of Illinois, *Customer Service Center: A Telecom Coordinator Guide*, 1.

⁴⁴⁶ New York State, *Enterprise IT Shared Services, Service Level Agreement: Customer Networking Solutions Details*.

Pennsylvania: Like Florida, the Commonwealth contracts with a telecommunication provider to serve state agencies' end-to-end network needs. Also under that contract, the commonwealth-owned Capitol Campus Fiber Network in Harrisburg, COPANET, will be managed by Verizon.

16.4 Availability of Services to Local Units of Government

In the vein of realizing economies of scale, all of the states examined, like Florida, make the state network, state contract, or both, available, at least to some extent, to local governmental entities and some other organizations. Also as in Florida, none of the states examined requires local entities to participate in the state network or purchase from the state contract. The Broadband Ohio Network planned to, and does support local government connectivity, but has not completed that plan due in large part to financial constraints. Pennsylvania and Illinois make it clear to vendors and to potential providers of telecommunication services that use of the contract by local units of government is purely optional.⁴⁴⁷

Florida: Local units of government are permitted under Chapter 282 to purchase MFN and other SUNCOM services from DMS. At this time, approximately 16 percent of MFN revenues are received from Florida's cities and counties that are connected to MFN.⁴⁴⁸

Illinois: Local units of government may utilize the Illinois Century Network and central equipment contracts, but are not required to do so. Network equipment purchased through the ICN contract is available to local units of government and other ICN participants at a discount from the vendor's list price, but the contract makes it clear that ICN participating entities, "constituents," are not required to utilize the contract.⁴⁴⁹

New York: NYeNET is available to local and municipal government agencies and authorities. The NYeNet data communications network provides organizations with statewide connectivity. Those local entities may contract for IT services administered by the Office of General Services

⁴⁴⁷ Commonwealth of Pennsylvania, *Request for Proposals, General Description of Documents*. See also State of Illinois, *Contract Approval Sheet*, "Cisco Equipment and Services RFP."

⁴⁴⁸ Department of Management Services, *Division of Telecommunications Business Model*, 18.

⁴⁴⁹ State of Illinois Contract with AT&T for Cisco equipment, effective June 2008 through June 30, 2011 (with options for extension for a total of five additional years), "The State is contracting for the purchase of Cisco equipment, software, maintenance, and support to serve both the needs of the backbone network as well as the ICN's constituent networks. ICN constituent use of the contract is completely voluntary, although historically, 90% of constituents have elected to purchase Cisco equipment through a State established contract. . . . the State does not guarantee any minimum order quantities nor any minimum revenue. All equipment and services will be ordered as needed, if needed. . . . The State will have no minimum purchase obligation and resultant contract shall not restrict purchases. All legislated ICN constituents may utilize this contract. Additionally State and other governmental units (including not-for-profit entities) participating in the Joint Purchasing Program may also utilize this contract. This authority is governed by State's Standard Procurement Rules and the Governmental Joint Purchasing Act [30 ILCS 525]." State of Illinois, *Contract Approval Sheet*, "Cisco Equipment and Services RFP."

and municipalities are authorized to purchase services through aggregated contracts.⁴⁵⁰ In addition, OneNetNYS is New York’s “partner network” which provides access for county networks that are not managed by CIO/OFT, New York’s technology agency. OneNetNYS provides a single point of presence on NYeNET for each county-operated network to facilitate county access to the state data center and to eight participating state agencies.⁴⁵¹ Of the 63 counties in New York, which include the five boroughs of New York City, only three remote counties are not connected to OneNetNYS.⁴⁵²

Ohio: Local governments can purchase network services through the state as cooperative purchasing members provided they have entered into an agreement with Department of Administrative Services pursuant to state law.⁴⁵³ Local governments were to be transitioned onto Broadband Ohio on a case-by-case basis beginning in 2008, but that transition has not completely occurred due, in large part, to financial constraints.⁴⁵⁴

Pennsylvania: Local units that choose to participate in the state cooperative purchasing program can utilize the state’s main telecommunications contract that includes data network services.⁴⁵⁵ The state makes it clear to bidders in solicitation documents that purchasing from the state contract is purely discretionary on the part of participants in the state cooperative purchasing program.⁴⁵⁶

⁴⁵⁰ Local governments are included in the New York State Finance Law, Article XI, State Purchasing, Section 163 (10)e, <http://www.ogs.state.ny.us/purchase/snt/sflxi.asp>, accessed November 23, 2010.

⁴⁵¹ New York State, “Managed Network Services, OneNetNYS Network Integration.”

⁴⁵² Lynne Holt conversation with Tony Williams and Bill Butcher, New York State CIO-OFT, September 2010.

⁴⁵³ ORC 125.04 and ORC 125.18(F).

⁴⁵⁴ As observed by the Ohio Broadband Council, “many urban areas in Ohio have already developed local rings that consist of fiber-optic cables connecting educational, governmental, health-care and non-profit facilities together to better serve their constituencies. The plan [to develop the Ohio Broadband Network] can benefit urban areas by connecting these local rings directly to the OSCnet [Ohio Supercomputing Center network, now called OARnet] backbone to provide Internet connectivity or redundancy to institutions already connected to the local rings. Additionally, institutions already connected to the local rings now have direct access to other institutions connected to OSCnet [now OARnet]. Urban areas [in Ohio] will share in lower pricing/megabyte of bandwidth service; enjoy quality of service, service level agreement protection, and myriad of service options available to all participants of the Ohio Broadband program.” Ohio Broadband Council. “FAQs of Broadband Ohio.” <http://www.ohiobroadbandcouncil.org/faqs/index.shtml#17>, accessed September 19, 2010.

⁴⁵⁵ Commonwealth of Pennsylvania, *Request for Proposals, General Description of Documents*, 11-13.

⁴⁵⁶ As stated in the 2008 RFP for telecommunication managed services, “The Contractor understands and acknowledges that there is no guarantee that any prospective COSTARS Purchaser will place an order under this Contract, and that it is within the sole discretion of the registered COSTARS Purchaser whether to procure from this Contract or to use another procurement vehicle.” Commonwealth of Pennsylvania, *Request for Proposals, General Description of Documents*, 12.

16.5 Administration and Operation of Networks -- General Overview

The phrase “central administration” of state data networks has a slightly different connotation in each of the five states examined. In these states, agencies have various levels of flexibility in obtaining the types of network services they want. Like Florida, all of the states examined provide at least some end-to-end⁴⁵⁷ service, in particular to state agencies. Such an arrangement also impacts the scope of central network administration.

Florida: MFN is managed by DMS Division of Telecommunications (DivTel), an administrative unit that operates SUNCOM. DivTel’s costs (personnel and facilities) are recovered from SUNCOM customers allocating costs to services that are provided to state agencies and other eligible customers.

State of Florida executive branch agencies, other than state universities and the Department of Transportation for traffic control devices, must obtain telecommunications services from DMS. Local governments, state universities, public libraries and certain non-profit organizations may obtain, but are not required to obtain, such services from DMS.⁴⁵⁸

DMS purchases MFN services from AT&T using the technology described in the agency’s current long-range program plan:

MyFloridaNet uses local service provider infrastructure and a new technology known as Multi-Protocol Label Switching (MPLS) to maximize statewide communications access to all of Florida’s government entities, including state, local and qualified nonprofits. By providing more advanced services, it establishes a scalable networking platform to handle the ever increasing communications requirements of customers. As a new multi-purpose communications network, MyFloridaNet will replace virtually all of the existing data services and ultimately much of the voice services with more features and security at lower costs.⁴⁵⁹

MFN has been fully implemented and almost all state agencies data transport occurs over MFN. There are a few instances in which state agencies of data transport services using earlier Frame Relay infrastructure and use of ATM is almost non-existent.

Illinois: The ICN state network backbone facility is operated by the Department of Central Management Services BCCS. ICN provides communication links to and among Illinois schools,

⁴⁵⁷ As used in this description, “end-to-end” means the network includes backbone, middle mile and last mile infrastructure.

⁴⁵⁸ Section 282.703 Florida Statutes.

⁴⁵⁹ Department of Management Services, *Long-Range Program Plan*, 29

institutions of higher education, libraries, museums, research institutions, state agencies, units of local government, and other local entities. Certain ICN customers may maintain their own routers and some ICN users must obtain last mile connectivity from a third-party provider. Nine Regional Technology Centers provide technical services for the statewide network.⁴⁶⁰ BCCS also manages the Illinois Wireless Information Network (IWIN) through a contract between the state, Verizon Wireless, and Motorola. IWIN is primarily used by law enforcement agencies, including approximately 13,000 users in nearly 500 municipalities, state and federal agencies, and postsecondary educational institutions.⁴⁶¹

In addition to its responsibility for ICN and IWIN, the Bureau manages planning, procurement, maintenance, and delivery of other telecommunications services for state agencies and other governmental entities, public higher education institutions, and some non-governmental entities. BCCS also operates the Central Computer Facility that provides mainframe processing systems and support for most state agencies.⁴⁶²

New York: The CIO/OFT operates the state’s network NYeNet and directly provides services to participating agencies.⁴⁶³ New York state agencies may obtain data network services from an entity other than NYeNet with approval of the CIO/OFT. The Office for Technology also must approve connections to NYeNet.⁴⁶⁴ The state university system (SUNY) obtains broadband network services through a public university/community college network (SUNYNet).⁴⁶⁵ In addition, the four largest public research universities and other higher education institutions purchase network services from a statewide dedicated research and education network, NYSERNet.

NYeNet services include: customer core networking, such as network design, network monitoring and management, network changes and refresh, redundancy for catastrophic events, security, DHCP, DNS, authentication, remote networking, external maintenance and support. New York agencies utilizing NYeNet are responsible for protecting their network from all other users by installing and maintaining a firewall. Certain of the services available via NYeNet, *e.g.*,

⁴⁶⁰ Illinois Department of Central Management Services, “Regional Technology Centers.”

⁴⁶¹ Illinois Department of Central Management Services, “BCCS Services: Wireless.” Illinois Department of Central Management Services, “BCCS Services: IWIN Users.” Illinois Department of Central Management Services, *IWIN Subscriber List*.

⁴⁶² Illinois State-Bureau of Communication and Computer Services. “About Us” <http://bccs.illinois.gov/about.htm>, accessed November 12, 2010.

⁴⁶³ According to a 2009 report from the Office of the New York Comptroller, less than half of 60 state offices and agencies use **some or all** of OFT services. DiNapoli, *New York State Office of General Services: Interagency Consolidation of Administrative and Support Services*, 17-18. The legislative and judicial branches are excluded from the applicable statutory definition of “state agency.” New York State Technology Law, Sec. 101 (4).

⁴⁶⁴ Corcoran, “NYS Office of General Services Telecommunications Symposium.”

⁴⁶⁵ State University of New York, “SUNYNet Services.”

NOC and DNS, are only available to the State University of New York, and the City University of New York to support institutional business and administrative functions that are common to state government.

Ohio: The Ohio Department of Administrative Services Infrastructure Services Division (ISD) provides broadband services. As a precondition, customers must purchase from the Infrastructure Services Division Internet access or state wide area network access.

Statewide network base services include connectivity to Ohio’s backbone network, support from the Ohio Service and Security Center, state-provided Internet Access, and state intranet access. ISD provides a comprehensive array of data network services to state agencies in Ohio; however, there is a provision for flexibility to accommodate state agencies’ unique service demands: “Services are provided internally when costs are lower or important functions can be best met, or master contracts are developed to fulfill a shared need among agencies. Unique agency network procurements are supported when they are consistent with state standards.”⁴⁶⁶

Pennsylvania: Like Florida, Executive Branch agencies and certain independent agencies in Pennsylvania enter into service level agreements with the Office of Administration-Information Technology (Pennsylvania Information Technology) for telecommunication services that are procured via a statewide service contract.

16.6 Administration and Operation of Networks -- Performance and Accountability

All of the states examined address standards for network performance in some manner. New York also has SLAs between CIO/OFT and individual state agencies that address performance. Ohio central state contracts with telecommunication providers include performance standards that must be met by the vendor. Like the Florida telecommunication contract, the Pennsylvania contract with Verizon provides for benchmarking to ensure market competitive pricing of services during the life of the agreement.

Florida: “State of Florida networking infrastructure must provide sufficient functionality or robustness to meet the requirements for expanding networked applications and services. In order to fulfill these requirements, the Department of Management Services developed a new service known as the MyFloridaNet, an MPLS capable IP network. The MyFloridaNet network platform provides a very flexible, highly available and secure communications infrastructure especially designed to satisfy the growing demands of our customers’ high availability, multimedia capable and security sensitive applications.”⁴⁶⁷ MFN will provide a robust network with stringent service

⁴⁶⁶ Ohio.gov, “Information Technology, Unified Network Services.”

⁴⁶⁷ Department of Management Services, “MyFloridaNet.”

levels and enhanced security.

Illinois: ICN customers are provided with a schedule of target timelines for telecommunications service delivery.⁴⁶⁸ A Participation Agreement and a Service Agreement are signed by customers who wish to utilize ICN. Neither document enumerates any performance standards.⁴⁶⁹

New York: In New York, performance standards for NYeNet are established in the NYeNet Services Details document. This document outlines response times to outages based on three severity levels and five escalation upgrades. For the most critical outages, services must be restored with four hours but there is a provision for more flexibility depending on the magnitude of the problem (specified as Escalation 5).⁴⁷⁰ The target percentage of time for NYeNet Severity-1 incident to be resolved within 24 hours is 80 percent, and the percentage of time that such incidents were actually resolved in the prior year was 75 percent.⁴⁷¹ The target level for NYeNet availability is 99.999 percent and actual performance in the prior year was 99.97 percent.⁴⁷² Service level standards are also provided for all OFT services.⁴⁷³ Service levels for all OFT-provided network services can be found in the standard “Service Level Agreement for Enterprise IT Shared Services,” between agencies and the New York State CIO/OFT.⁴⁷⁴

In addition to performance standards that are included in infrastructure and service contracts, the New York Office of Inspector General and federal agencies may perform audits as provided for by the core services entered into by the Office for Information Technology and NYeNET users.

Ohio: Performance standards are specified in individual contracts. For example, the Department of Administrative Service’s contract with TW Telecom for Internet services requires without penalty 99.99 percent availability for outages under five minutes. If the outage lasts more than five minutes there is an escalating penalty, with the highest level penalty occurring if the outage lasts 48 hours or more.⁴⁷⁵

Pennsylvania: The Pennsylvania contract with Verizon contains three service levels against which the vendor’s performance is measured. Failure to meet those performance levels may

⁴⁶⁸ Department of Central Management Services, *Telecommunications Service Intervals*.

⁴⁶⁹ Illinois Century Network, *Network Services Participation Agreement*. See also Illinois Century Network, *Illinois Century Network Service Agreement*, “ICN/CMS and the Champaign County Courthouse.”

⁴⁷⁰ New York State, *Enterprise IT Shared Services, Service Level Agreement: NYeNet Service Details*.

⁴⁷¹ New York State, *Performance Dashboard of Service Level Performance Measurements*.

⁴⁷² New York State, *Performance Dashboard of Service Level Performance Measurements*.

⁴⁷³ Ibid.

⁴⁷⁴ New York State, *Service Level Agreement for Enterprise IT Shared Services*. Accessed September 20, 2010 . This service level agreement program is a new initiative. Previously, state agencies were confused about services provided and the rates associated with them. This program is designed to clarify OFT and state agency responsibilities and the rates for each service.

⁴⁷⁵ Ohio.gov., *Service Attachment 5*, 17.

result in the state receiving service credits.⁴⁷⁶ For most critical services, including among others, enterprise Internet service, remote access, and WAN service, the maximum time allowed for restoration from a service outage is 24 hours. WAN services to critical locations, as defined in the contract, must be restored within four hours of an outage.⁴⁷⁷ The Pennsylvania contract also requires a joint annual service level review. As part of that review, proposed adjustments to service levels will be made to incorporate improved technology, processes, or changes in measurements used to establish the service levels.

The Pennsylvania contract also provides that federal and state agencies may perform audits of financial/compliance, economy/efficiency, or program results. The Auditor General of Pennsylvania has broad authority to audit agency activities. An audit of the contract for telecommunication services between the Office of Administration and Adelpia for the period 1998 to 2002 found that the Office of Administration was not adequately managing the contract.⁴⁷⁸ The Pennsylvania contract with Verizon provides for annual price, technology, and best practices reviews. The object of the price reviews is to ensure that the fees charged by Verizon are within the lowest quartile of prices for similar services. The objective of the technology and best practices reviews is to identify means of reducing price or improving performance.⁴⁷⁹

16.7 Administration and Operation of Networks – Financing

All of the states examined operate their data networks and related services with fees collected from agencies to which services are provided. The method for calculating the amount to be recovered from network users varies among the states. Illinois operates the ICN with a combination of state general fund financing and a system of cost recovery.

Florida: DMS is required by statute to “develop a system of equitable billings and charges for communications services.”⁴⁸⁰ Pricing of SUNCOM and MFN services has two components: recovery of the costs for the service paid to the vendor (e.g., AT&T) plus recovery of DivTel’s costs (personnel and facilities which are categorized as direct or indirect costs of services). In order to recover DivTel costs of staff, office space and related support costs from users, these

⁴⁷⁶ Commonwealth of Pennsylvania, *Schedule F, Service Level Methodology* of the contract states that, “if the Contractor fails to [meet the required service levels] and is not otherwise excused from such failure, the Contractor shall take the corrective actions and may be subject to the other remedial measures specified in this Schedule F and the Contract.”

⁴⁷⁷ Commonwealth of Pennsylvania, *Schedule E, Critical Services*.

⁴⁷⁸ Casey, *Special Audit of the Telecommunications Services Contract*.

⁴⁷⁹ Commonwealth of Pennsylvania, *Request for Proposals, General Description of Documents*, “Schedule O.”

⁴⁸⁰ Section 282.703(2) Florida Statutes.

costs are allocated on top of vendor costs of the service.⁴⁸¹

SUNCOM uses a “cost-plus” allocation method to determine the cost of providing each service. This is most appropriate for internal providers that primarily buy (rather than build) services that are in turn resold to enterprise customers.⁴⁸² Approximately 92 percent of SUNCOM’s costs are such payments to vendors. The remaining eight percent pays for the costs of designing, procuring, and managing these services and the enterprise networking model. [These] costs are added to vendor charges for SUNCOM services (“cost plus”). Some specific services bear more than others based upon the share of administrative resources committed to offering the service and other factors like the cross subsidies [used to fund technological change].⁴⁸³

According to DMS, staff/management costs are allocated to particular services based on time spent for that service. There are two crucial principles for DMS pricing of services. First, DMS operates under an internal mandate that “no price shall go up.” This appears to be for at least two reasons: organizationally, DMS work to obtain advantages of combined purchasing power and related price reductions; and increasing prices to its customers (state agencies) would tend to cause budget problems. Second, DMS is moving toward an ideal that “net income” for any category of service equals zero. At this time, DMS has 17 categories of service with varying net incomes. While obviously a mandate of “zero net income” is impossible to achieve at all points in time due to service development, unforeseen economic factors (e.g., high unemployment drives higher usage therefore higher revenues at agencies serving the unemployed), and fluctuating volumes due to customer choice, “zero net income” is an appropriate management goal for pricing. Ultimately, the financial imperatives, beyond these pricing considerations are to maintain trust-fund solvency, to maintain timely payment of vendors, and to maintain fiscal management ability to properly provision services.

DMS notes regarding its cost recovery mechanism that:

⁴⁸¹ Calculated for Fiscal Year 2009-2010, total SUNCOM (DivTel) overhead costs of \$9.5 million comprise 8 percent of SUNCOM collectible revenue of \$117 million. The DMS objective is to set prices for each service such that direct vendor costs plus allocated staff/management costs plus allocated indirect/overhead costs are recovered with “zero net income” for any service. According to DMS, DivTel must accumulate a “cushion” of funds for contingency as a matter of prudent management, but if the fund balance rises too high, internal policy and federal requirements (e.g., OMB A-87) lead to price reductions or rebates to maintain no more than appropriate fund balances.

⁴⁸² Endnote omitted.

⁴⁸³ Department of Management Services, *Division of Telecommunications Business Model*, 33. Endnote 37 further provides that “SUNCOM is compelled to subsidize some services as a result of start-up and service retirement costs, broader public policy decision, aggregate enterprise concerns, leadership and political directives.”

[a] dilemma inherent to SUNCOM's purpose of fostering customer savings comes with SUNCOM's self-funded model. As SUNCOM assists customers with reducing costs, SUNCOM's opportunity to recover administrative costs diminishes. This tends to push SUNCOM's mark-up percentage higher. To counter this, SUNCOM seeks to expand its customer base to include more discretionary users and broaden its base of services.⁴⁸⁴

Illinois: As set out in the ICN Service Agreement, "Participants who are ICN Primary constituents receive a specified quantity of Ports and Bandwidth paid with funds appropriated to the ICN by the state legislature. Services above that which is paid with state funds, are charged back to the Participant as stipulated in the ICN Cost Recovery Policy. Participants who are Non-Primary constituents pay for all Ports and Bandwidth based on ICN's cost to provide these services."⁴⁸⁵ The ICN operating budget is currently approximately \$32 million. Financing is composed of user fees (approximately 56 percent), a state appropriation (approximately 41 percent), and e-rate (approximately 3 percent).⁴⁸⁶

Presentations for ICN regional meetings in October 2010 included a high level description of a new cost recovery model under development. That model will distribute state funding for primary ICN constituents via credits. As indicated in the presentation, recommendations regarding the new cost model will be presented to the Policy Committee with a target of implementation to coincide with new services resulting from the East Central Illinois Broadband Opportunity Project.⁴⁸⁷

New York: The most recent New York SLA states that rates for services provided by the CIO/OFT are established annually after consultation with agencies, and consideration of other variables, to develop demand projections and to identify costs for needed volumes of service. Among the information considered when estimating service usage are agency submissions of the Annual Technology Plans, results of customer discussions, and other external sources. Rates are frozen for the fiscal year to the extent possible.⁴⁸⁸ Monthly bills for services are calculated

⁴⁸⁴ Department of Management Services, *Division of Telecommunications Business Model*, endnote 9.

⁴⁸⁵ "Allowance" provision in the "Illinois Century Network, *Illinois Century Network Service Agreement* Primary constituents are K- 12 schools (public and private), institutions of higher education, libraries and museums. Non-primary constituents are all others including research institutions, State agencies, units of local government and other local entities that provide services to Illinois citizens. See also Central Management Services, "Illinois Century Network: Cost Recovery FAQs," <http://www.illinois.net/cost%20recovery/crFAQ.htm>, accessed November 9, 2010.

⁴⁸⁶ Sorenson, "Illinois Century Network Perspective."

⁴⁸⁷ Illinois Century Network, *Regional Meetings*.

⁴⁸⁸ The following formula is used to determine rates: Estimated Cost of Providing Service / Estimated Volume of Billable Units +/- Reconciliation = Annual Rate Per Billable Unit. Described in New York CIO/OFT. "Service Level Agreement (SLA) Frequently Asked Questions." http://www.cio.ny.gov/SLA/SLA_FAQ.htm, accessed September 21, 2010.

based on the number of circuits an agency used during the previous month.⁴⁸⁹ The distributed nature of charges that determine rates means that controls must be imposed on agencies exiting the user base.⁴⁹⁰

Ohio: Like Florida, Ohio has a cost recovery mechanism that generates revenue to support the operation of the Infrastructure Services Division. That fee is equal to two percent of the cost of services purchased by state agencies, as specified in contracts with providers.⁴⁹¹ Ohio State agencies pay a connection fee based on bandwidth and pay for individual circuits which can be purchased through the state’s contracts with telecommunication providers at discounted rates. Pricing is set on a case-by-case basis based on speed for local access and port.

Pennsylvania: The core of OA-IT is financed by the State General Fund, (approximately \$42 million for FY 2011⁴⁹²); however, that appropriation does not include telecommunications charges that are recovered from each agency. In addition, agencies are charged for services such as security, some monitoring, and others provided by OA-IT. Other funding sources have enabled improvements to network infrastructure. For example, in 2007 OA-IT obtained a \$7.8 million loan from the Commonwealth’s Productivity Bank⁴⁹³ to build its own fiber optic network infrastructure in the Capitol Complex in Harrisburg, COPANET.

⁴⁸⁹ The procedure for calculating monthly bills is discussed in detail in New York State, *Enterprise IT Shared Services, Service Level Agreement: NYeNet Service Details*, 15.

⁴⁹⁰ For the procedure governing termination of network services, see New York State, *Service Level Agreement for Enterprise IT Shared Services*, 37.

⁴⁹¹ As an example, see Ohio.gov., *Amendment 1 to Service Attachment 1, Opt-E-Man and CSME Service*. Contract amendment signed 10-24-08 by OIT.

⁴⁹² The FY 2011 State General Fund appropriation of approximately \$42.4 million was reduced in August 2010 by approximately \$806,000 to approximately \$41.6 million. Commonwealth of Pennsylvania, *2010-11 Spending Reductions, General Fund*.

⁴⁹³ The Pennsylvania Productivity Bank was created to make loans to state Executive Branch agencies to finance management and productivity improvements. The Productivity Bank is governed by a committee composed of Governor’s Chief of Staff, Secretary of the Budget, Secretary of Administration, Secretary of Policy and Planning, Secretary of General Services, Secretary of Revenue, the Chief Financial Officer, and the director of the Governor’s Office of Management and Productivity. To be eligible for a loan from the Productivity Bank, a project must cost at least \$100,000 and be able to generate sufficient post-implementation savings to repay the loan within three to five years. In addition to repaying the loan, borrowing agencies must make either interest payments or a “savings share” payment to the Productivity Bank. After the original loan has been repaid, agencies are required to make a one-time “savings share” payment to the Bank, generally representing half of the annual savings realized by the project.

17 Higher Education Networks

Next, we provide a more detailed context for our policy recommendations regarding centralization and governance in Volume 1.

For the most part, the establishment of broadband research and education networks is a recent phenomenon that builds upon centuries of academic research collaboration, teaching, and information dissemination. Perhaps it is understandable that the oldest non-government-dedicated network of this sort was established in New York City where there was a presence of top-notch research universities in the metropolitan region, willing providers to invest in the networks and corporate interests to support them, and, at that time, the concentration of advanced computing facilities. Under such conditions, New York's dedicated network, NYSERNet, grew from the discussion stage in 1985 to a viable network in 1987. It leased fiber from telecommunication service providers until 2004, when it began providing its own backbone services to the American Museum of Natural History, and in 2005, when it extended operations statewide through use of Dense Wave Division Multiplexing technology.⁴⁹⁴

17.1 The National Context

In the 1990s, more state research and education networks were created as a result of university demand for high-speed computing capability, and access to dark fiber. Some networks are exclusively university-based and operate as an intranet, such as New York's SUNYNet or Penn State University's Integrated Backbone. Other networks connect K-12 schools or a cluster of schools through a central node, universities, and libraries and, in some cases, museums and government research institutions, and are located in a mixture of rural and urban states: NYSERNet, the Illinois Century Network, OARnet, Kansas' KanREN, Missouri's MOREnet, Texas' LEARN, California's CENIC, and FLR, are all examples. As of July 2010, there were approximately 37 state research and education networks.⁴⁹⁵

The proliferation in recent years of broadband research and education networks in the U.S. appears to have been spurred in large part by four developments: the emergence of Internet 2, National LambdaRail, the not-for-profit organization EDUCAUSE⁴⁹⁶; and the establishment of supercomputing centers affiliated with research universities.

Internet2 originated as a project of 34 researchers in 1996. It was formally organized in 1997 as a not-for-profit corporation, under the name of the University Corporation for Advanced Internet Development (UCAID) in 1997, and subsequently changed its name to Internet2. In partnership with Qwest in 1998, UCAID built Internet2, a fiber optic backbone network known as Abilene

⁴⁹⁴ NYSERNet, "History," <http://www.nysernet.org/history.php>, accessed September 23, 2010.

⁴⁹⁵ Cavanaugh, and Kuhns, "KINBER/PennREN Overview," 12.

⁴⁹⁶ See <http://www.educause.edu/about>.

that links member networks for purposes of education and research. Internet2 reports having as members more than 200 U.S. universities; 70 corporations; 45 government agencies, laboratories and other institutions of higher learning; as well as over 50 international organizations.⁴⁹⁷

Thirty-three research and education network members support Internet2 through annual membership fees. Among others, members of Internet2 include the following research and education networks: FLR, NYSERNet in New York, and OARnet in Ohio.⁴⁹⁸ Other state and regional education networks, such as Illinois Century Network, utilize Internet2 through the Sponsored Education Group Participants program.⁴⁹⁹

Internet2 also invested in the National LambdaRail project. National LambdaRail is a 12,000 mile fiber optic network owned by 13 regional networks, including FLR and the Pittsburgh Supercomputing Center, a joint effort of Carnegie Mellon University, the University of Pittsburgh, and Westinghouse Electric Company. National LambdaRail offers different membership tiers with different levels of benefits but all users are entitled to end-to-end support services through National LambdaRail's Network Operating Center housed at the University of Indiana. Among other sites, National LambdaRail's points of presence are located in Chicago, New York City, Syracuse, Cleveland, Pittsburgh, Philadelphia, Jacksonville, and Pensacola.⁵⁰⁰

Another development that has stimulated states' interest in research and education networks is the establishment of supercomputers at many research institutions throughout the nation. Supercomputers are used for a wide array of number-crunching applications for both pure and applied research. A 2010 ranking of the world's 500 commercial supercomputers, in terms of their power, housed at university, federal and corporate research sites, includes Stony Brook/BNL New York Center for Computational Sciences, (ranked 67th), Rensselaer Polytechnic Institute, Computational Center for Nanotechnology Innovations in New York (ranked 80th), the National Center for Supercomputing Applications at Champagne-Urbana (ranked 82nd), and Ohio's Supercomputer Center at Ohio State University (ranked 126th).⁵⁰¹ Because supercomputers generate and transmit data very rapidly, they require large bandwidth capacity.

Supercomputers and the networks that support them can contribute to economic development.

⁴⁹⁷ Internet2. "About Us." <http://www.internet2.edu/about/>, accessed September 23, 2010.

⁴⁹⁸ Internet2. "R&E Network Members." <http://www.internet2.edu/renm/member.cfm>, accessed September 23, 2010.

⁴⁹⁹ "Sponsored Educational Group Participants are aggregations of educational organizations brought together in a state-wide or other wide-area network within a state. Examples of these aggregations are state-wide K-12 networks, community college networks, and similar collectives of educational organizations. These networks are engaged in applications development and other projects designed to enhance their use of advanced networking infrastructure and services." http://www.internet2.edu/network/participants/sponsored_faq.html. See also Internet2. "List of SEGPs." <http://www.internet2.edu/network/participants/listSEGP.cfm>, accessed September 25, 2010.

⁵⁰⁰ National LambdaRail, "Services Map by Point-of Presence."

⁵⁰¹ Top 500 Supercomputer Sites, "Top500 List."

For example in August 2010, Ohio’s Supercomputer Center received \$300,000 in federal funds to work with a ceramics manufacturer and university researchers to improve the company’s operations.⁵⁰² The Ohio supercomputer will be used for advanced simulations and modeling. In September, 2010, a research group at Pittsburgh’s Supercomputing Center received a federal grant of almost \$1 million to develop software that will enable more efficient use of high capacity networks.⁵⁰³

In addition to the networks that support other state government functions, education and research networks also are spurred by the infusion of stimulus money and ongoing technological changes. As proving grounds for new technology, research and education networks will undoubtedly continue to transform themselves. The sciences driving network improvements, training of IT personnel, IT content development, and the federally driven push for broader scale connectivity with partners in the preK-12, health care, and economic development communities will continue to place universities in the foreground of network expansion. New types of partnerships may also present university-based research and education networks with alternatives for obtaining broadband services at advantageous terms and prices. Much depends on the extent to which these networks have discretion to purchase services from sources other than state contracts.

17.2 Higher Education State Strategic Plans

The confluence of Internet2, the National LambdaRail capabilities, and the establishment of supercomputing facilities across the country and internationally has enabled university-based research and education networks to assume central roles in state economic development strategic plans. One facilitator of global competitiveness, typically part of state strategies, is high-speed broadband use, and another is high-skilled jobs. Access to IT and high-speed networks can be viewed a precondition for such jobs. So it is perhaps not surprising that state legislatures view the support of research and education networks as vehicles for state economic development. For example, the president of New York’s research and education network, NYSERNet, chaired the Broadband Infrastructure Access Action Team for New York’s broadband strategic plan, *Connecting New York to the World for Sustainable Adoption*. The task force was charged with identifying and mapping the state’s baseline areas with and without broadband access infrastructures. The link between New York’s supercomputer centers, their ability to leverage federal research dollars, and the importance of “last mile” broadband deployment to transfer commercialization opportunities to non-university settings is perhaps captured most effectively in the following paragraphs of the plan:

For New York to remain a leader attracting federal research dollars it must be closely aligned with the federal government’s goal and objectives for its

⁵⁰² Ohio Supercomputer Center, “Grant Funds Simulation & Modeling Study.”

⁵⁰³ Pittsburgh Supercomputing Center, “Pittsburgh Supercomputing Center Receives \$980,000.”

programs. By making necessary improvements to our current research network infrastructure and staying ahead of the curve on strategic mandates of federal research agencies, New York research universities will have a considerable advantage in leveraging federal research dollars.

In keeping with this premise, New York State is home to major supercomputing centers, e.g., Rensselaer Polytechnic Institute’s Computational Center for Nanotechnology Innovations, Stony Brook/ Brookhaven National Lab, and the University at Buffalo. Leveraging existing infrastructure and connecting “last mile” systems with high speed broadband will enable New York to create jobs as a result of accelerated research and commercialization initiatives (emphasis in original).⁵⁰⁴

Indeed, the mission of research and education networks may include economic development as one of its primary purposes. Such is the case with FLR⁵⁰⁵ and the Illinois Century Network. One of the legislative findings that resulted in creation of the Illinois network in 1999 was “that computing and communications technologies are essential for sustaining economic competitiveness and fostering the educational vitality of this State.”⁵⁰⁶ The mission and vision statements of the Keystone Initiative for Network Based Education and Research (KINBER) for Pennsylvania’s new fiber network, PennREN, also include economic development and workforce training objectives.⁵⁰⁷

17.3 Organizational Structure

Dedicated research and education networks follow several models. The networks may be authorized and governed by statute as is the case for the Illinois Century Network and Ohio’s OARnet.⁵⁰⁸ The latter “. . . was founded in 1987 to provide Ohio researchers with their first ‘online’ access to the high performance computing resources of the Ohio Supercomputing Center, established in Columbus in the same year.”⁵⁰⁹ Unlike the Illinois Century Network which has express statutory authority, OARnet was established under general authority of the Ohio Board of Regents.⁵¹⁰ Some research and education networks are not state operated, but are governed by a consortium of public institutions that form a not-for-profit corporation. Examples

⁵⁰⁴ New York State, *Connecting New York to the World*, 41.

⁵⁰⁵ See <http://www.flrnet.org>. [“The Florida LambdaRail, LLC (FLR) was created to facilitate advanced research, education, and economic development activities in the State of Florida, utilizing next generation network technologies, protocols, and services.”].

⁵⁰⁶ 20 ILCS 3921/5(1).

⁵⁰⁷ KINBER, “About KINBER,” <https://www.kinber.org/>, accessed September 23, 2010.

⁵⁰⁸ 20 ILCS 3921/, Illinois Century Network Act. O.R.C., section 3333.04(V) “Chancellor – Powers and Duties.”

⁵⁰⁹ OARnet. “About OARnet,” <http://www.oar.net/about/>, accessed September 23, 2010.

⁵¹⁰ O.R.C., section 3333.04(V).

of this approach include FLR, NYSERNet, and Pennsylvania’s newly created KINBER.⁵¹¹ Like their statutorily established network counterparts, their general missions include providing high-speed network connectivity to advance knowledge and research and educational initiatives. The non-profit consortium approach to organizing and managing these networks may be seen as more flexible in some respects than approaches based on a more traditional state government delivery system such as the Illinois Century Network. For example, these networks often benefit from the inclusion of private education and research organizations in organizational decision-making structures.

As is the case for networks that support other aspects of state government, dedicated research and education networks can either be operated by the state and utilize leased facilities and equipment as does the Illinois Century Network, or owned and operated by the state or by the non-profit entity, as in New York, Ohio and Florida, or a combination of the two. Following the examples of networks like FLR and NYSERNet, KINBER plans to own and operate its own network.

17.4 Characteristics of Higher Education Networks

There are three inter-related features characterizing research and education networks: 1) they often have access to dark fiber; 2) they are collaborative; and 3) they are viewed as a cost-saving measure for their respective states.

17.4.1 Availability of Dark Fiber

University-based research and education networks have benefited from the abundance of dark fiber in their respective states and regions and the funding support to purchase or lease it. For example, FLR has the ability to add many high speed (10 Gbps and up to 100 Gbps) circuits by “lighting up” additional lambdas over its owned DWDM optical wave system.⁵¹² In its earlier years, NYSERNet leased its backbone but subsequently purchased sufficient fiber to build a statewide system, and also to build a metro-fiber network in New York City, along with a data center co-location facility in the City.⁵¹³ OARnet initially leased its backbone. However, OARnet began to experience an aggregated growth in university broadband traffic of 30 percent per year and operating costs that were increasing by 25 percent annually. These and other factors contributed to the decision to purchase dark and used fiber from telecommunications providers and other providers throughout the state.⁵¹⁴ Illinois’s I-Wire (Wired/Wireless Infrastructure for Research and Education) is a state-funded, dark-fiber network connecting ICN

⁵¹¹ Florida LambdaRail, “Florida LambdaRail Governance.” NYSERNet <http://www.nysernet.org/about/>, and Keystone Initiative for Network Based Education and Research, “Draft By-Laws.”

⁵¹² Veronica Sarjeant. Written communication to David Brevitz. January 14, 2011.

⁵¹³ NYSERNet, “History,” <http://www.nysernet.org/history.php>, accessed September 27, 2010.

⁵¹⁴ Cisco Systems, “OARnet Builds Statewide Optical DWDM Network.”

and a number of research facilities in the Chicago area: the Argonne National Laboratory, the Illinois Institute of Technology, Northwestern University, the University of Chicago, and the University of Illinois at Chicago with the University of Illinois at Urbana-Champaign's National Center for Supercomputing Applications. I-WIRE provides lambda services between I-WIRE sites and StarLight (an advanced optical network exchange located at Northwestern University's downtown Chicago campus).⁵¹⁵ The FLR backbone also is statewide, composed of optical fiber obtained under a 20-year lease.⁵¹⁶

Pennsylvania's new research and education network consortium, KINBER, plans to build a statewide fiber network for education (all levels), research, healthcare, and economic development organizations. PennREN will benefit, to some extent, from the market for dark fiber. Of the 96 strands of optical fiber that will be installed, 48 strands will be for PennREN.⁵¹⁷ The remaining fiber pairs will be retained for commercial purposes by a KINBER partner. The fiber partner's primary business is providing wholesale transport for service providers.⁵¹⁸

17.4.2 Collaboration

Research and education broadband networks have always been largely the products of collaborative efforts, as NYSERNet illustrates. For some networks, particularly networks that are directly part of state government, like OARnet and the Illinois Century Network, ongoing state financial support, and the user community collaboration that fosters that support, have been critical. Collaborative support of research and education networks by the constituent community, even when that community is largely composed of public institutions, does not necessarily translate into direct financing through the appropriations process. For example, FLR receives no direct state funding and the Pennsylvania legislature did not directly appropriate funding for the establishment of PennREN. NYSERNet, and FLR generate revenue through annual membership fees, as will PennREN. OARnet is supported by a combination of membership dues and direct state support.

Collaborative efforts are required to establish and maintain all research and education networks, even those that have state-owned and operated backbones. Networks rely on institutional partnerships to provide administrative, content, and technical support. They also rely on vendors to provide the necessary technology. For example, FLR will connect to the new Emerald Coast

⁵¹⁵ National Center for Supercomputing Applications, "I-WIRE Activation." See Illinois Wireless Infrastructure for Research and Education, "The State of Illinois I-Wire." See also Indiana University, "Facilities-based Regional Optical Networks."

⁵¹⁶ Florida LambdaRail, "Infrastructure." Because Florida LambdaRail owns the optical equipment and has what is termed as an "indefeasible right of use," the arrangement is considered by Florida LambdaRail to be network ownership.

⁵¹⁷ Reel, "Keystone Initiative for Network Based Education and Research."

⁵¹⁸ Keystone Initiative for Network Based Education and Research, "KINBER and PennREN Overview."

Technology Park in Oskaloosa County, enabled by funding from Enterprise Florida, and by fiber provided by the County through a network formed for that purpose.⁵¹⁹ OARnet’s web page provides the perfect example. Its network partners include ConnectOhio, dubLink, eTechOhio, the Ohio Broadband Council, Ohio Community Computing Network, the Ohio Board of Regents, the Ohio Department of Education, the Ohio Learning Network, OhioLink, the Ohio Supercomputer Center, Onecommunity, the Southern Ohio Health Services Network, Telehealth Video Resource Center, and the University System of Ohio. In addition to collaborators, the complexity of large networks requires purchase of services from a number of vendors. In the case of OARnet, vendor partners include American Electric Power, Fiber Systems, Appalachian Power, AT&T, Buckeye TeleSystem, Cicso Systems, CITYNET, First Communications, Horizon, Juniper Networks, Level (3) Communications and LifeSize.⁵²⁰ In Florida, three research universities are collaborating to develop a supercomputing grid (Sunshine Grid) that connects to FLR. To that end, the universities received a total of \$450,000 from the Florida Board of Governors in late 2010 under the New Florida Initiative.⁵²¹

Successful ARRA grant awards to establish or extend research and education networks may be the product of collaborative efforts as KINBER in Pennsylvania reflects: charter members of KINBER include Bucknell University, Carnegie Mellon University, Drexel University, Lehigh University, Pennsylvania State System of Higher Education, Pennsylvania State University, the University of Pennsylvania, the University of Pittsburgh, the Commission for Community Colleges, the Association of Independent Colleges, and Universities and the Hospital and Health Systems Association of Pennsylvania.⁵²² KINBER anticipates additional partnerships, such as the Pennsylvania Economic Development Association; the Pennsylvania E-Health Initiative; Geisinger (a physician-led health care system); public television stations; UPMC (a large non-profit health system headquartered in Pittsburgh); Temple, University of Scranton; MAGPI and 3ROX (both regional network aggregation points); county governments; and private sector service providers. Another example is the successful application by three organizations comprising the Ohio Middle Mile Consortium serving Ohio for a total exceeding \$141 million in ARRA money to extend broadband infrastructure throughout northeast, western, and southern Ohio. The consortium includes a partnership of Horizon Telcom, OneCommunity, Com Net, Inc., and OARnet.⁵²³

Connectivity and collaboration are the cornerstone of the Connected Nation initiatives throughout the country and of the federal funding under BTOP, which encourages such

⁵¹⁹ Halstead, “Florida’s Infrastructure Needs,” 57-62.

⁵²⁰ Ohio.gov, “OARnet Network Partners.”

⁵²¹ Crabbe, “Board Awards UF Grants.”

⁵²² Keystone Initiative for Network Based Education and Research, “KINBER and PennREN Overview.”

⁵²³ Ohio.gov, “Ohio Receives Additional \$111.3 Million.”

collaboration.⁵²⁴ Perhaps the ultimate collaborative effort is exemplified by the U.S. Unified Community Anchor Network, also known as the U.S. UCAN project, which is part of national I2, to be funded by a \$62.5 million ARRA grant from the National Telecommunications and Information Administration (NTIA). A proposed 3.2 Terabit per second network, UCAN will feature community colleges among its potential 200,000 community anchor institutions. FLRNet will be an access provider to the U.S. UCAN network.⁵²⁵ Partners in this initiative include National LambdaRail, Internet 2, and the Northern Tier Network Consortium, together with four vendors: Ciena, Cisco, Infinera, and Juniper Networks.⁵²⁶

17.4.3 Saving Money

At least in some instances, the political support for research and education networks is linked to the perception that they are a possible means of saving money. For example, when budgets were cut in 2009, Ohio's Governor Strickland spared OARnet, arguing: "In order to maintain the infrastructure necessary to support and expand system-wide efficiencies, I have exempted OARnet from any budget reductions. OARnet is the cornerstone of our ability to achieve Information Technology savings across the system."⁵²⁷ Some services offered by OARnet and other research and education networks appear to save member institutions money. An example is discounted rates for Internet access made available through membership in an organization called the Quilt. Participants in the Quilt include FLR, and NYSERNet, among others.⁵²⁸ Virtualization tools⁵²⁹ also can be made available to universities and state agencies through aggregated purchases by research and education networks. OARnet assumed that responsibility in Ohio. As of September 2010, 17 of 24 state cabinet agencies and 27 of the 40 largest state agencies began using the tool which was purchased through OARnet.⁵³⁰ These tools can also be obtained through state-level aggregated procurements, as has been done by the New York's Office for Technology.⁵³¹ It depends on a state's procurement configuration as to how such purchases are handled.

⁵²⁴ Connected Nation. "Who We Are." http://connectednation.org/who_we_are/, accessed September 24, 2010. National Telecommunications and Information Administration. "Broadband Technology Opportunities Program: Frequently Asked Questions." February 10, 2010. http://www2.ntia.doc.gov/files/NOFA2_FAQs.pdf, accessed September 24, 2010.

⁵²⁵ Veronica Sarjeant. Written communication to David Brevitz. January 14, 2011.

⁵²⁶ U.S. Unified Community Anchor Network, "National Research and Education Partnership Awarded \$62.5 Million."

⁵²⁷ Ohio Board of Regents, *FY 09 Budget Reductions*, 2.

⁵²⁸ Quilt, "Quilt Participants."

⁵²⁹ These tools allow copies of the same operating system or several different operating systems to run on one computer.

⁵³⁰ Zurier, "Ohio's Higher Ed Engine."

⁵³¹ New York State, *Enterprise IT Shared Services, Service Level Agreement: Enterprise Data Center Service Details*, 27-29.

Aggregated purchasing and shared services are an effective means of saving money and state IT strategic plans are apt to include such objectives. For example, among the guiding principles for Illinois' state information systems is the statement that, "Common Information Systems will provide the opportunity for greater IT Asset and Resource advantage, improved economies of scale and reduced costs. In addition to common shared systems, common business processes should be shared to further reduce costs."⁵³²

Universities are authorized, but not required to purchase broadband and network services utilizing state contracts in Ohio, New York, and Pennsylvania, for example. OARnet's network contracts are administered by Ohio State University. New York's State University System had purchased intranet and Internet connectivity from the AT&T state contract, but now uses best-cost providers for intranet (SUNYNet) and Internet (SUNYNet IP services).⁵³³ New York's public universities, except for the administrative offices of the State University System and City University, do not use the state backbone, NYeNet. The four largest research universities on the SUNY system (Albany, Stony Brook, Binghamton, and Buffalo) also purchase broadband services from NYSERNet, as do other public universities, but broadband purchasing decisions in the SUNY system are determined by individual campuses. The City University of New York has a more centralized approach for purchases for its colleges.⁵³⁴

⁵³² Illinois Department of Central Management Services, *State of Illinois - IT Guiding Principles*.

⁵³³ "How do I order a new SUNYNet service," <http://www.suny.edu/sunynet/faq.cfm?navLevel=3#>, accessed September 29, 2010.

⁵³⁴ Lynne Holt conversation with Sharon Akkoul, NYSERNet, September 27, 2010.

18 K-12 and Public Library Networks

Next, we provide a more detailed context for our policy recommendations regarding governance and education in Volume 1.

18.1 Overview

Facilitating the use of broadband technology in K-12 public schools and libraries is often considered an integral part of a state’s broadband strategy. This perspective is typically articulated in Governors’ executive orders, statutes, or strategic plans. For example, New York’s universal broadband strategic plan includes schools and libraries as necessary recipients of connectivity support.⁵³⁵ The Broadband Ohio Network clearly contemplates K-12 schools as part of a comprehensive broadband network serving state agencies, local governments, and higher education, as envisioned in Executive Order 2007-24S.⁵³⁶ Pennsylvania’s broadband strategy likewise acknowledges the importance of broadband services for schools and libraries.⁵³⁷ One finding of the legislation creating the Illinois Century Network is, “that a network is required that will deliver educational programs, advanced training, and access to the growing global wealth of information services to citizens in all parts of this state.”⁵³⁸ Indeed, ICN was an outgrowth of an earlier Illinois K-12 education network, LincOn, which was in operation for four years prior to enactment of the Illinois Century Network Act.⁵³⁹

The scope of the Illinois Century Network, which provides centralized broadband services to state agencies, local government, higher education institutions, museums, and hospitals, is the exception among the four states examined for comparison to Florida. In Ohio, Pennsylvania, New York and Florida, more decentralized models were contemplated. In Florida, the legislature recognized in 2009 “that broadband Internet service is critical to the economic development of the state and is beneficial for libraries, schools, colleges and universities, health care providers and community organizations,” and directed DMS to work collaboratively with Enterprise Florida, state agencies, local governments, private businesses, and community organizations to

- conduct a broadband needs assessment;
- create a strategic plan for increasing broadband use in the state;
- build and facilitate local technology planning teams that include K-12 and library members; and

⁵³⁵ New York State, *Connecting New York to the World*.

⁵³⁶ State of Ohio, Executive Order 2007- 24S, *Establishing the Ohio Broadband Council*.

⁵³⁷ Pennsylvania Office of Administration, *Broadband Strategy for the 21st Century*.

⁵³⁸ See 20 ILCS 3931/5(3). <http://www.ilga.gov/legislation/ilcs/ilcs3.asp?ActID=393&ChapterID=5>, accessed September 24, 2010.

⁵³⁹ Illinois Department of Central Management Services. “Frequently Asked Questions,” <http://www.illinois.net/faqs/questions.htm>, accessed September 21, 2010.

- encourage the use of broadband Internet service through grant programs.⁵⁴⁰

Other recent Florida initiatives recognize the critical role broadband will play in educating students as well as members of the community. In October 2010, the Florida Senate Committee on Education Pre-K-12 issued Interim Report 2011-115 that addresses 2010 legislation that encourages local school districts to develop Learning Management Systems (LMS).⁵⁴¹ A reference is made to it in Vol. 1. LMS provides electronic access to curriculum, individualized instruction, robust resources, ongoing assessments, professional development, and student achievement data in a secure environment. Access is available to students, teachers, parents, and administrators on an anytime, anywhere basis using a variety of technology tools.

In the report, the committee points to the critical juncture at which schools are regarding technology:

Public schools are at a point to engage in a much bolder transformation of education powered by technology. The U.S. Secretary of Education, Arne Duncan, describes this point in time as a revolutionary opportunity for change, driven by the continuing push of emerging technology and the pull of the critical national need to radically improve our education system. However, enticing technology and the urgent need to improve teaching and learning must be addressed within the context of sound fiscal policies and practices so that tax dollars are invested rather than simply expended...Although several school districts continue to expand their use of technology to enhance teaching and learning, Florida as a whole appears to be without a collaboratively developed technology plan that clearly describes how technology will be used to improve teaching and learning and that identifies statewide policy directives to which state and local IT investments can be aligned. To attain this goal, a framework that describes the required minimum IT infrastructure must be agreed upon and then deployed.

The committee finds that only seven Florida districts currently deploy a fully operational electronic LMS that encompasses desired functionalities. The report cites America's 2008 Digital Schools Report, which describes features needed for a LMS to be viable, as articulated by students, teachers, and district technology directors. Desired LMS features include the following:

- Formative assessment and remediation;

⁵⁴⁰ Ch.364.0135, Florida Statutes.

⁵⁴¹ Florida Senate, "School District Information Technology Procurement." Refers to ch. 2010-154, L.O.F.

- Teacher collaboration;
- Storage and delivery of assessments;
- Integration of curriculum and assessment in one system;
- Traditional courses supplemented with online instruction;
- Rich, high-quality content from a variety of sources;
- File exchange and homework submission;
- Online learning courses;
- Discussion forums;
- Assignments that are customizable to meet student needs;
- Complete integration with the Student Information Systems;
- Tagged, scalable content that aligns to curriculum standards; and
- Support for integrated streaming video.

Achieving the goal of implementing LMS in Florida school systems clearly will require widespread availability of broadband networks to schools throughout the state.

18.2 Public School Networks

Over the years, public schools adopted different strategies to derive the benefits of broadband networks. In the absence of statewide broadband networks that included non-state agencies, like the Illinois Century Network, many dedicated education networks emerged. For example, Pennsylvania’s PAIUNet, provides broadband service for the Commonwealth’s 29 Intermediate Units serving K-12 schools, the public library system and charter schools.⁵⁴² Several Intermediate Units and school districts also belong to the Three Rivers Optical Exchange, a regional network aggregation point that serves academic, government and commercial entities in western Pennsylvania and West Virginia.⁵⁴³

FIRN also was conceived as an education network and has retained its identity as such throughout the years. FIRN was established in 1982 “with a primary mission to serve as a data communication transport vehicle for Florida’s public education system and to provide equitable

⁵⁴² “Intermediate Units in Pennsylvania are part of the governance structure of public education in the Commonwealth. They are located in the middle between the state education agency and the local school districts. They were designed primarily to provide services to local school districts that can be operated more effectively and efficiently on a regional basis. Intermediate Units also have been given the responsibility of providing programs/services to students attending the non public schools in their regional area. The majority of the programs offered by intermediate units are supported by federal, state or district contributions. Intermediate units are dependent upon these sources of funding since they do not have taxing power.”

<http://www.aiu3.net/Level2.aspx?id=1466>, accessed September 25, 2010.

⁵⁴³ See <http://paiunet.org>, accessed September 23, 2010.

data network connections for every school district, community college, and university.”⁵⁴⁴ Wider use of FIRN for library connectivity was authorized through a proviso in a 1984 appropriations bill authorizing development of an automated library system including the state universities, private academic institutions, community colleges, and libraries.⁵⁴⁵ FIRN (and the version superseding it, known as FIRN2) is a SUNCOM service, and supported by the AT&T network that also supports MFN. FIRN2 provides dedicated services to the education community, including K-12 schools, community colleges, universities, and the University of Florida Institute of Food & Agriculture Sciences. The service is outsourced through a contract between DMS, on behalf of the Florida Department of Education (DOE), and AT&T (and partners). A portion of FIRN2 costs, ineligible for E-rate funding, was funded through annual appropriations to the DOE until FY 2009-2010. During that fiscal year, the DOE was permitted by proviso to utilize a portion of the general state aid through the Florida Education Finance Program to support the E-rate ineligible costs of FIRN2. The FY 2010-2011 appropriation to the DOE did not include any direct appropriation for FIRN2, nor did it include permissive proviso language regarding the FIRN2 costs. However, school districts may use their general state aid allocation to pay for broadband connectivity.⁵⁴⁶

In August 2008, in the interval between FIRN and FIRN2, DOE issued a Request for Proposal to continue FIRN capabilities outside SUNCOM.⁵⁴⁷ Two months later, DMS also issued a Request for Proposal for the same services.⁵⁴⁸ Table 18-1 shows a comparison of DOE’s original separate procurement pricing to DMS FIRN2 procurement to current MFN pricing.⁵⁴⁹ The FIRN2 prices are for the same services and education users as the DOE offer. MFN is also able to serve these clients with these services, but is also generally available to other governmental and nonprofit entities as well.

Table 18-1 displays savings that were computed based on simple averaging of the prices for each bandwidth level. On that basis FIRN2 procured through SUNCOM is nearly 40 percent less costly than the pricing offered to DOE through its own procurement, while pricing for provision of the service over MFN is 62 percent less costly than the DOE procurement using the new MFN rates from the contract extension plus recovery of DMS administrative costs.

⁵⁴⁴ Florida Department of Education, *Report to the Joint Library Planning Committee*, 52.

⁵⁴⁵ *Ibid.*, 17.

⁵⁴⁶ Conversation between Lynne Holt and Ron Lauver, Florida Department of Education, October 5, 2010.

⁵⁴⁷ Office of Program Policy Analysis and Government Accountability, *Strategic Plan Developed to Enhance FIRN2 Services*, 4. See also Department of Management Services, *Division of Telecommunications Business Model*, 9-10.

⁵⁴⁸ Office of Program Policy Analysis and Government Accountability, *Strategic Plan Developed to Enhance FIRN2 Services*, 4.

⁵⁴⁹ Calculations provided by DMS.

Table 18-1. Comparison of Pricing from Agency Procurement versus Enterprise Procurement

Bandwidth	Best Offer to DOE	SUNCOM FIRN2 Service w/ Admin. Costs	SUNCOM MFN Non-Renewal	SUNCOM MFN Non-Renewal with DMS Cost Recovery	SUNCOM MFN Renewal	SUNCOM MFN Renewal with DMS Cost Recovery
DSL	\$300	\$96.52	\$327.26	\$345.68	\$321.85	\$339.89
T1	\$700	\$586.24	\$575.60	\$611.40	\$560.55	\$595.30
3 Mbps	\$1,025	\$920.97	\$876.76	\$933.64	\$868.44	\$924.74
6 Mbps	\$2,050	\$1,695.88	\$1,361.52	\$1,450.34	\$1,305.73	\$1,390.64
9 Mbps	\$2,575	\$2,491.89	\$1,425.06	\$1,518.33	\$1,352.73	\$1,440.93
12 Mbps	\$3,000	\$2,722.80	\$1,527.37	\$1,627.80	\$1,433.74	\$1,527.61
15 Mbps	\$3,225	\$2,867.12	\$1,615.69	\$1,722.30	\$1,500.06	\$1,598.58
21 Mbps	\$3,675	\$3,463.27	\$1,958.18	\$2,088.77	\$1,785.54	\$1,904.04
33 Mbps	\$4,725	\$3,919.54	\$2,444.28	\$2,601.09	\$2,174.05	\$2,311.94
45 Mbps	\$6,625	\$4,579.23	\$2,735.21	\$2,912.38	\$2,361.80	\$2,512.83
75 Mbps	\$8,875	\$5,372.62	\$4,093.41	\$4,365.65	\$3,127.17	\$3,331.78
90 Mbps	\$10,000	\$6,208.31	\$4,093.41	\$4,365.65	\$3,127.17	\$3,331.78
100 Mbps	\$10,750	\$6,208.31	\$4,651.38	\$4,962.68	\$3,544.60	\$3,778.43
155 Mbps	\$16,500	\$7,069.02	\$6,275.84	\$6,700.86	\$4,558.99	\$4,863.82
200Mbps	\$18,900	\$8,007.65	\$7,279.49	\$7,769.19	\$5,110.46	\$5,448.33
Average	\$6,195	\$3,747	\$2,749	\$2,932	\$2,209	\$2,353
Savings		39.5%	55.6%	52.7%	64.3%	62.0%
Rates = bundle pricing using unbundled components (Local Loop + CPE + Port + Internet) MFN = 0-10 miles Local Loop Pricing 75Mbps not available under MFN; used 90Mbps MFN rate 90Mbps not available under SUNCOM FIRN; used 100Mbps FIRN rate						

Source: Department of Management Services, *Division of Telecommunications Business Model*, Endnote 13; email from Bill Price, DMS to David Brevitz, Public Utility Research Center, University of Florida, January 11, 2011.

As might be expected, the savings that were computed based on overall averaging differ from computed savings for particular bandwidths. Table 18-2 shows these results. Comparative savings increase as the bandwidth increases, with the greater savings at the higher bandwidth level impacting the calculation of the average savings. DSL is actually somewhat more expensive under MFN than under the DOE procurement.

FIRN2 appears to have evolved as a separate agreement due to a view on the part of the DOE that MFN would not be eligible for E-rate funding. According to DMS, “DOE’s request that

Table 18-2. Comparison of Pricing for Select Bandwidth Levels, DOE and DMS Procurements

Bandwidth	Best Offer to DOE	SUNCOM FIRN2 Service w/ Admin. Costs	SUNCOM MFN Non-Renewal	SUNCOM MFN Non-Renewal with DMS CR	SUNCOM MFN Renewal	SUNCOM MFN Renewal with DMS CR
Savings		67.83%	-9.09%	-15.23%	-7.28%	-13.30%
DSL	\$300	\$96.52	\$327.26	\$345.68	\$321.85	\$339.89
Savings		16.25%	17.77%	12.66%	19.92%	14.96%
T1	\$700	\$586.24	\$575.60	\$611.40	\$560.55	\$595.30
Savings		10.15%	14.46%	8.91%	15.27%	9.78%
3 Mbps	\$1,025	\$920.97	\$876.76	\$933.64	\$868.44	\$924.74
Savings		9.24%	49.09%	45.74%	52.21%	49.08%
12 Mbps	\$3,000	\$2,722.80	\$1,527.37	\$1,627.80	\$1,433.74	\$1,527.61
Savings		11.10%	49.90%	46.60%	53.49%	50.43%
15 Mbps	\$3,225	\$2,867.12	\$1,615.69	\$1,722.30	\$1,500.06	\$1,598.58
Savings		57.63%	61.48%	58.89%	72.96%	71.17%
200Mbps	\$18,900	\$8,007.65	\$7,279.49	\$7,769.19	\$5,110.46	\$5,448.33

Source: Department of Management Services, *Division of Telecommunications Business Model*, Endnote 13; email from Bill Price, DMS to David Brevitz, Public Utility Research Center, University of Florida, January 11, 2011. Authors' calculations.

SUNCOM establish another FIRN service rather than use existing services (MyFlorida Network; MFN) was a result of DOE claims that MFN services were not compliant with E-rate grant restrictions.”⁵⁵⁰

However, the MFN contract⁵⁵¹ contains a number of provisions that support eligibility for E-rate funding through the federal universal service fund. Section 4.3.11 of the MFN contract appears designed to provide assurance that the MFN contractor is and will maintain eligibility as, a service provider for E-rate. The contract at Section 4.3.11 includes provisions such as:

- “Contractor shall maintain eligibility as a USF service provider for the duration of the MyFloridaNet Contract. Contractor understands that DMS seeks to obtain E-rate funding for all eligible services sold under this Contract to all eligible entities. Contractor shall comply with current and future USF certification requirements to remain a Service

⁵⁵⁰ Department of Management Services, *Division of Telecommunications Business Model*, endnote 11.

⁵⁵¹ *MyFloridaNet Contract*.

Provider under the program during the life of this Contract.”

- Provision of “Evidence of Current Eligibility” by providing Service Provider Identification Numbers used and required in the E-rate program.
- Provision of E-rate customer care through dedicated E-rate support personnel.
- Provision of E-rate training to DMS as well as additional support regarding what items may be eligible for support under the program, coordination to reduce cash flow requirements via inclusion of funding reference numbers, and assistance in evaluating appeals if funding is initially denied.

In the midst of the differing views between DOE and DMS noted earlier, the Office of Program Policy Analysis & Government Accountability stated: “For the same services that were generally included in the previous contract for \$6.9 million annually, DMS determined that the price from AT&T would be \$3.8 million.”⁵⁵² This case provides one view of how prices can differ depending on the approach used to obtain bids. We did not fully investigate the differences between the DOE and DMS approaches, but the large differences in prices obtained from two bidding processes for the same services, the same customers, and at about the same time, indicates that the contracting entity and approach matter.

New York, Pennsylvania and Ohio all use a more regional approach to providing network services to school districts than does Florida. In New York, Internet connectivity is provided through 12 Regional Information Centers (RICS) in partnership with nonprofit Boards of Cooperative Educational Services (BOCES) computer centers.⁵⁵³ Six of the RICS are connected to New York’s high-speed backbone, NYSERNet.⁵⁵⁴ In contrast to Pennsylvania’s PAIUNet, (an independent entity governed and operated by the statutorily created Intermediate Units,) New York’s BOCES are statutorily authorized units within the New York Department of Education. The services available through the RICS are services provided by BOCES. They manage local and regional networks and provide technical support to the school districts.⁵⁵⁵ Similar to New York’s model, Ohio’s network, the Ohio Education Computer Network (OECN), provides IT service to 23 information technology centers (ITCs) that, in turn, serve seven large urban school districts in Ohio.⁵⁵⁶ OARnet, the technology operations arm of the University System of Ohio, provides the backbone for the ITCs. The OECN receives state funding through the Ohio

⁵⁵² Office of Program Policy Analysis and Government Accountability, *Strategic Plan Developed to Enhance FIRN2 Services*, 4, footnote 6.

⁵⁵³ Boards of Cooperative Educational Services, “BOCES of New York State.

⁵⁵⁴ Lynne Holt conversation with Sharon Akkoul, NYSERNet, September 27, 2010 .

⁵⁵⁵ “What is a RIC?”

http://www.boces.org/wps/portal/BOCESofNYS/About/WhatIsARIC/?WCM_GLOBAL_CONTEXT=/wps/wcm/connect/WCProd/BOCES+of+NYS/About/What+is+a+RIC/What+is+a+RIC, accessed September 22, 2010.

⁵⁵⁶ “About the MCOECN,” <http://www.mcoecn.org/AboutUs.aspx>, accessed September 22, 2010.

Department of Education’s budget.

18.3 Public Library Networks⁵⁵⁷

Public library networks evolved somewhat differently depending on the state’s support of such initiatives. Florida public libraries rely on local resources for broadband services but they do receive approximately \$21 million in state aid annually from the Division of Libraries and Information Services. Some libraries use the state aid appropriation for library connectivity. However, most libraries use this funding source for other purposes.⁵⁵⁸ There is no statewide network for libraries in Florida.

In Illinois, public libraries may obtain services from the Illinois Century Network. Ohio’s public libraries are connected via the Ohio Public Library Information Network (OPLIN). The Ohio Office of Information Technology provides OPLIN network support under contract. OPLIN provides and manages a physical network using Ethernet circuits.⁵⁵⁹ In New York there are 23 regional state-funded public library systems that are responsible for network management and Internet connectivity.⁵⁶⁰ Authority for public library systems to receive state aid is established in statute.⁵⁶¹ There is no statewide network for libraries in New York.

Pennsylvania does not have a state-sponsored public library network either, but public libraries are able to utilize the state telecommunication contract to purchase network services. Some public and private libraries have banded together into countywide library systems, such as the Lancaster Library System, to share, among other things, Internet connectivity and IT technology support.⁵⁶² While the state does not operate a data network for libraries, the Office of Commonwealth Libraries in the Pennsylvania Department of Education administers the federal Library Services and Technology Act funds. The funds are used in part for a competitive grant program open to public, academic, school, and other libraries and library consortia. Among eligible technology projects are installation of LAN or WAN infrastructure to connect to

⁵⁵⁷ Review of this section was requested from Mark Flynn, Loretta Flowers and Judith Ring at Division of Libraries and received in time for final publication of this report. We appreciate and acknowledge the review of this section provided by management at Division of Libraries.

⁵⁵⁸ Interview by David Brevitz, Public Utility Research Center, University of Florida, with Judith Ring, Loretta Flowers, Mark Flynn, Jill Canono, and Amy Johnson of the Department of State, Division of Libraries, August 20, 2010.

⁵⁵⁹ “About OPLIN,” <http://www.oplin.lib.oh.us/content/about-oplin>, accessed September 22, 2010.

⁵⁶⁰ See <http://www.nysl.nysed.gov/libdev/libs/brochurp.htm>, accessed September 24, 2010.

⁵⁶¹ New York Education Law Section 272, <http://www.nysl.nysed.gov/libdev/excerpts/edn272.htm#1-PLS>, accessed September 24, 2010.

⁵⁶² “About the Library System of Lancaster County,”

<http://www.lancasterlibraries.org/lslc/cwp/view.asp?a=3&q=466987>, accessed September 22, 2010. See also Allegheny County Library Association. <http://www.aclalibraries.org/>, accessed September 24, 2010.

networks and to the Internet.⁵⁶³ The 2008-2012 Five Year Plan for use of Library Services and Technology Act Funds, prepared by the Office of Commonwealth Libraries of the Department of Education, included as the first of two goals, “Expand access to information resources for all Pennsylvania residents through infrastructure support and support for activities that enhance resource sharing.”⁵⁶⁴ Several of the desired outcomes of that goal focus on development of necessary infrastructure to support collaboration and resource sharing.

18.3.1 Florida’s Public Libraries

There are 79 public library systems with 555 total service outlets (including branches and bookmobiles). These libraries are supported in various ways by the Division of Library and Information Services within the Department of State. The Division of Library and Information Services is the designated information resource provider for the Florida Legislature and all state agencies, and houses the State Library and State Archives. It also coordinates and helps to fund activities of public libraries, provides a framework for statewide library initiatives, provides archival and records management services, and preserves, collects, and makes available the published and unpublished documentary history of the state. The Division of Libraries distributes \$21 million in state aid to libraries based on formula. For some small libraries with smaller tax bases this constitutes 55 percent of annual funding. This funding can be spent on anything but bricks and mortar. The variability of funding sources may be seen from review of State Library statistical reporting. Public libraries are generally very dependent on city or county budget funding. Very few public libraries have independent taxing authority.⁵⁶⁵

The Division of Libraries also uses approximately nine million dollars in federal funding from the Institute of Museum and Library Sciences, to support The Florida Electronic Library and competitive grant programs for libraries in the state. Division of Libraries also provides training, e-rate assistance and consulting type assistance to public libraries in Florida.⁵⁶⁶

18.3.2 Provision of Information Resources Using Broadband Technology in Florida

We note one of the axioms among libraries is that “every library is different.” Subject to that caution, we believe our research has permitted some general observations to be made. Libraries operate on-premise networks (behind the premise demarcation point) consisting of a mix of workstations for patron access, local area networking, wireless networking, network servers and

⁵⁶³ Pennsylvania Department of Education, *Technology Component Grant Application Guidelines*.

⁵⁶⁴ Zales, *Library Services and Technology Act Five-Year Plan 2008-2012*, 4.

⁵⁶⁵ Interview by David Brevitz, Public Utility Research Center, University of Florida, with Judith Ring, Loretta Flowers, Mark Flynn, Jill Canono, and Amy Johnson of the Department of State, Division of Libraries, August 20, 2010.

⁵⁶⁶ *Ibid.*

associated closet space/power for equipment, and software. Libraries' broadband connections to the Internet are obtained from a variety of sources, including connection to city/county fiber networks, FIRN2, and other providers.

Broadband availability in Florida's libraries was recently studied to provide assessment of network inventories and bandwidth for Florida's public libraries. The State Library and Archives of Florida contracted with Hayes e-Government Resources to perform these tasks and to make recommendations for improving broadband capacities as part of the Florida Broadband Capacity Building Project. In August 2010, Hayes issued a "Technology Assessment Report" in which it notes that the decline in Florida's economy, the collapse of the housing market, and high unemployment all have precipitated increased use of libraries for access to online resources.⁵⁶⁷ In addition to research, the Internet is being used by patrons for getting up-to-the-minute news, watching videos, downloading audio books, listening to music, storing personal files, etc., and by library personnel to conduct library business. The biggest demand for Internet access at public libraries is to conduct e-government transactions. Examples include completing online job applications, interacting electronically with local, state, and federal e-government tasks, such as applying for social security benefits, or unemployment benefits, and collaborating with local and state emergency/disaster management services in times of emergencies.⁵⁶⁸

Hayes notes that most of the library systems it reviewed for the project are part of WANs that connect libraries for sharing resources and services. Mentioning the burgeoning use of cloud computing, Hayes argues that, "For libraries offering free Internet access to people in the community, maintaining enough bandwidth in support of the free service that can be used in so many different ways by patrons and staff is a challenge." However, based on its sample bandwidth testing procedures, Hayes concludes that although the National Broadband Initiative proposed minimum goal speeds for broadband services of 256 Kbps upstream and 768 Kbps downstream, it is not necessary to have that much bandwidth per computer in Florida's libraries for today's information user. Noting that future bandwidth-intensive applications will demand higher speeds, Hayes recommends that for now, a library with less than 25 computers should have an allocation of 384 Kbps per computer and those with more than 25 computers should have 300 Kbps per computer.

The technology assessment studied 171 public library sites using premise visits. The Technology Assessment Report provides both general information in summary form, and information for each site studied. The site-specific information may be used in planning and implementing increased broadband access, and to improve and modernize computing capacity.

⁵⁶⁷ Hayes e-Government Resources, Inc., *Hayes, IT Consulting Technology Assessment Report*. ("Hayes Report").

⁵⁶⁸ Interview by David Brevitz, Public Utility Research Center, University of Florida, with Judith Ring, Loretta Flowers, Mark Flynn, Jill Canono, and Amy Johnson of the Department of State, Division of Libraries, August 20, 2010.

Furthermore, the Report provides information necessary to sustain and broaden broadband technology use by libraries by increasing participation in the federal E-rate program. These results appear to be very robust, since 171 of 511 libraries (or one third of Florida’s libraries) were studied. Funding has been obtained through award of supplemental funding to DMS by the NTIA State Broadband Data Development program to perform similar technology assessment for the 180 Florida public libraries in rural and underserved communities using the same approach.⁵⁶⁹

The Report “revealed common factors influencing the ability of Florida’s public libraries to provide an optimal technology environment for delivering library services. Most of these can be traced back to the amount of bandwidth available, the number and age of computers using the connection including the wireless guest patron machines, and the network equipment in place.”⁵⁷⁰ Summary findings include:

- *Bandwidth:* The majority of public libraries would benefit from controlling per user bandwidth. With controls in place, the library can measure actual bandwidth needs to determine if an increase in the amount of bandwidth is required. Bandwidth for library systems must support the amount aggregated from all local sites.
- *Connection Speeds:* Approximately 70 percent of the connection speeds at public library sites are described as slow or very slow at times.
- *Public Workstations:* the majority of public libraries expressed a need for additional workstations. They described waiting lists and patrons queued up for their turn to use a computer or the Internet.
- *Age of Workstations:* approximately 56 percent of the public workstations in the selected libraries are over four years old. Outdated workstations presented problems, a few of which include: connecting to the Internet, slowing down network throughput, software incompatibility, not meeting minimum specifications to run software, and accessing newer media.
- *Networking Equipment:* old equipment and consumer grade equipment was evident at many sites. Most of it is still functional, but replacing it with commercial grade equipment that has newer features for management and security will increase the efficiency of the network, maximize available bandwidth, and provide information to find and correct network problems.
- *Wireless Access:* Most libraries have open access for wireless and no restraints on its use, which affects the network throughput. At many sites, wireless access is available with no acceptable terms of use agreement or rate limiting of the amount of bandwidth used.

⁵⁶⁹ Department of Management Services, *Division of Telecommunications Business Model*, 12.

⁵⁷⁰ Hayes e-Government Resources, Inc., *Hayes, IT Consulting Technology Assessment Report*, 4.

- *Funding*: while the public use of library services has increased, library funding and budgets have been cut. E-rate is a source of funding that public libraries can use for discounts on Internet access, telecommunications services, or internal connections if they meet program requirements. Many of the public libraries file E-rate applications for some services, but they are not taking advantage of all of the opportunities available in the E-rate program.⁵⁷¹

The Hayes Report provides significant analysis of why it appears libraries are not taking advantage of E-rate program opportunities.⁵⁷²

18.4 Broadband Purchasing for K-12 Schools and Public Libraries

States share the notion that aggregated purchases of broadband services for K-12 public schools and libraries can save money. In keeping with that objective, Florida helps school districts to reduce broadband costs through the FIRN2 contract described above. With the 2009 “E-Rate Contract for Internet Access and Telecommunications Services,” DMS introduced on its website “the new FIRN Network,” with the following features:⁵⁷³

FEATURES	BENEFITS
Data transport provided by MFN	MFN transport operates within highest industry standards to secure and deliver data.
Bulk pricing and simplicity	Significantly reduced prices with simpler rate structure, easier to manage for end user.
Multiregional Internet Gateway Access	Multiple Internet Gateways throughout State of Florida providing most efficient access available to Internet
Guaranteed Quality	Commitment to users from service providers; strict SLAs.
E-Rate Benefits	E-rate compliant to benefit the educational community to ensure E-rate funding for major portion of these services.

⁵⁷¹ Ibid.

⁵⁷² Hayes e-Government Resources, Inc., *Hayes, IT Consulting Technology Assessment Report*, 16-18.

⁵⁷³ http://dms.myflorida.com/suncom/suncom_products_and_pricing/data_transport_services/erate_contract_for_internet_access_and_telecommunications_services_firn, accessed January 5, 2011.

DMS summarizes the variety of packages and optional offerings of telecommunications and Internet services available to FIRN2 subscribers. The website also provides information on which services are eligible for E-rate and provides an “E-Rate and Monthly Pricing Calculator.”

FIRN2 is provided by two vendors under a single contract. The networking and transport is provided by AT&T using MFN. IP-voice, content filtering, firewall and the network management of the hosted services is provided by an AT&T subcontractor. FIRN2 offers bundled service, e-mail, content filtering, web hosting, interconnected VoIP, CPE management services, data vault service, and other services.

The Office of Program Policy Analysis and Government Accountability notes “the unbundled package provides Internet access only; this option is used primarily by universities and community colleges.”⁵⁷⁴ The FIRN2 contract is scheduled to expire on June 30, 2012, with a three-year renewal option. The network services that are provided by AT&T to support FIRN2 leverage DMS’s MFN contract.

According to DMS, “FIRN uses the MFN infrastructure provide by AT&T, but includes some E-Rate qualified features, like email and special filtering, that are not a part of MFN.”⁵⁷⁵ Therefore, DMS plans that FIRN2 should be provisioned via MFN at the expiration of the FIRN2 contract. Given the procurement pricing in Tables 18-1 and 18-2, FIRN2 contract renewal or rebidding is not contemplated by DMS. In order to use MFN to substitute for FIRN2 services, DMS will need to provide the mechanism to separate out service and cost components that are eligible for E-rate program funding from those that are ineligible for funding. DMS presently separates E-rate eligible costs and services from ineligible for FIRN2 via the “E-Rate and Monthly Pricing Calculator.” DMS is in the process of developing the “E-Rate and Monthly Pricing Calculator” for use with MFN, to separate out the E-rate eligible services and their costs. For example, SUNCOM overhead is not an eligible cost to be covered by E-rate funding, and must be separated out via the E-Rate and Monthly Pricing Calculator. E-rate funds are provided subject to audit for proper use. DMS is very aware that the state cannot risk having a school district or library failing audit while using MFN, and is working to replicate its FIRN2 E-Rate and Monthly Pricing Calculator for use with MFN upon FIRN2 contract expiration. This will permit MFN to be used as the State Master Term Contract for E-rate purposes.⁵⁷⁶

In addition to the services DMS makes available to schools and libraries through the FIRN2 contract, DMS also makes available telecommunications services to schools and libraries

⁵⁷⁴ Office of Program Policy Analysis and Government Accountability, *Strategic Plan Developed to Enhance FIRN2 Services*, 2.

⁵⁷⁵ Department of Management Services, *Division of Telecommunications Business Model*, 15.

⁵⁷⁶ Interview by David Brevitz, Public Utility Research Center, University of Florida, with Bill Price, Department of Management Services, February 17, 2011.

through other contract vehicles, as explained below in the E-Rate Funding section. K-12 schools and libraries are not *required* to purchase services from the FIRN2 and other DMS contracts.

In other states we reviewed, school districts may utilize state contracts for broadband service procurement. School districts in New York can purchase broadband services through BOCES, which can, but are not required to, purchase broadband services from state contracts. School districts in Illinois and Pennsylvania are also authorized, but not required, to purchase broadband services or equipment from state contracts. Illinois school districts would do so through the Illinois Century Network. Pennsylvania’s school districts would do so through PAIUNet, or through the State Telecommunication contract. In Ohio, a separate agency, eTech Ohio, was statutorily established in 2005 to, among other things, “provide funding, technical and telecommunications services to public broadcasters and the K-12 community.”⁵⁷⁷

18.4.1 Federal Funding for Broadband in Schools and Libraries

As education networks and initiatives evolved in Florida and other states, federal funding became available to partially offset connectivity costs. The largest federal source of support for K-12 education and library networks is the federal Universal Service Schools and Libraries Program, commonly known as “E-rate,” discussed earlier. This support, which initially became available in 1998, enables K-12 schools and libraries to purchase eligible equipment and services at a discount (20 to 90 percent) based on economic need and urban or rural location. Eligible equipment and services are classified into four categories: Telecommunications, Internet Access, Internal Connections, and Internal Connections Maintenance. Applicants typically obtain broadband infrastructure and high-speed Internet access through single connections in the case of individual schools and libraries or, in the case of school districts, library systems, and other consortiums, through large bandwidth network solutions that usually connect to the Internet through a central point.

In addition to E-rate funding, schools in rural areas are able to secure broadband infrastructure connectivity through several USDA Rural Utilities Service programs that finance new construction and upgrades to telecommunications infrastructure, including the Broadband Loan Program (Farm Bill), the Distance Learning and Telemedicine Grant Program, and the Community Connect Broadband Program.⁵⁷⁸

Federal ARRA funds also have been authorized to reduce broadband access problems encountered by anchor institutions, including schools and libraries in unserved and underserved areas, and to promote awareness and adoption of broadband technology. The second round of NTIA BTOP grants specifically were aimed at filling in middle-mile broadband connectivity

⁵⁷⁷ “eTech Ohio About Us,” <http://www.etech.ohio.gov/about-us/>, accessed September 22, 2010.

⁵⁷⁸ U.S. Department of Agriculture, “Telecommunications Loans and Grants.”

gaps, the reason for lack of broadband access in many schools and libraries, particularly in rural areas.

Tables 18-3–18-7 show the ARRA projects for our five states that will at least in part enable school/library connectivity and promote broadband use for educational purposes.⁵⁷⁹

Although not solely dedicated to infrastructure and connectivity, other federal sources of education technology funding that can be used for such expenditures, or for other purposes that promote the use of broadband technology, come from U.S. Department of Education programs. In its 2011 Operating Legislative Budget Request, the DOE requested budget authority for the disbursement to school districts of grant awards from several programs, including:

- Enhancing Education Through Technology (EETT), known as the Technology Literacy Challenge Fund prior to the passage of No Child Left Behind Act of 2001. The purpose of EETT is, “to improve student academic achievement through the use of technology in schools, assist all students in becoming technologically literate by the end of eighth grade, and encourage the effective integration of technology with teacher training and curriculum development to establish successful research-based instructional methods.”⁵⁸⁰ Florida 2010 EETT funds totaled more than \$27 million and were used to support Next Generation Sunshine State Standards in instructional activities, teacher professional development, collaborative teaching and learning opportunities, and online assessments. DOE competitively awarded the funds to all but seven school districts in the state.⁵⁸¹
- 21st Century Community Learning Centers, the purpose of which is “to provide opportunities for communities to establish or expand activities in community learning centers for academic enrichment; to offer families of participants opportunities for literacy and related educational development.”⁵⁸²

⁵⁷⁹ National Telecommunications and Information Administration, “Grants Awarded.” These grants do not fund ongoing telecom or operating costs.

⁵⁸⁰ Florida Department of Education, *2011-2012 Legislative Budget Request*, 215

⁵⁸¹ Florida Senate, “School District Information Technology Procurement.” Calhoun and A.D. Henderson DRS submitted proposals but were unsuccessful. Hardee, Indian River, Jefferson, FSDB, and FAMU DRS did not submit proposals.

⁵⁸² Florida Department of Education, *2011-2012 Legislative Budget Request*.

Table 18-3. Florida ARRA Projects for Schools and Libraries

Grantee	Total Award	Type
<u>City of Tallahassee</u>	\$1,212,020	<u>Sustainable Adoption</u>
<u>Communication Service for the Deaf, Inc.</u>	\$14,988,657	<u>Sustainable Adoption</u>
<u>Florida A&M University</u>	\$1,477,722	<u>Public Computer Centers</u>
<u>Florida Department of Management Services</u>	\$8,877,028	<u>Broadband Data & Development</u>
<u>Florida Rural Broadband Alliance</u>	\$23,693,665	<u>Infrastructure</u>
<u>Level 3 EON, LLC</u>	\$2,066,250	<u>Infrastructure</u>
<u>North Florida Broadband Authority</u>	\$30,142,676	<u>Infrastructure</u>
<u>One Community</u>	\$18,701,771	<u>Sustainable Adoption</u>
<u>One Economy Corporation</u>	\$28,519,482	<u>Sustainable Adoption</u>
<u>School Board of Miami-Dade County</u>	\$3,473,498	<u>Sustainable Adoption</u>
<u>Tampa Housing Authority</u>	\$2,131,322	<u>Sustainable Adoption</u>
<u>University Corporation for Advanced Internet Development</u>	\$62,540,162	<u>Infrastructure</u>

Table 18-4. New York ARRA Projects for Schools and Libraries

Grantee	Total Award	Type
<u>City of New York</u>	\$13,917,562	<u>Public Computer Centers</u>
<u>City of New York SBA</u>	\$5,962,124	<u>Sustainable Adoption</u>
<u>Communication Service for the Deaf, Inc.</u>	\$14,988,657	<u>Sustainable Adoption</u>
<u>ION Hold Co., LLC</u>	\$39,724,614	<u>Infrastructure</u>
<u>New York City Department of Information Technology and Telecommunications</u>	\$22,162,825	<u>Sustainable Adoption</u>
<u>New York Department of Labor</u>	\$536,737	<u>Public Computer Centers</u>
<u>New York State Education Department</u>	\$9,521,150	<u>Public Computer Centers</u>
<u>NY State Office of Cyber Security & Critical Infrastructure</u>	\$8,923,532	<u>Broadband Data & Development</u>
<u>One Economy Corporation</u>	\$28,519,482	<u>Sustainable Adoption</u>
<u>Portland State University</u>	\$3,318,031	<u>Sustainable Adoption</u>
<u>Saint Regis Mohawk Tribe</u>	\$641,750	<u>Public Computer Centers</u>
<u>University Corporation for Advanced Internet Development</u>	\$62,540,162	<u>Infrastructure</u>
<u>Vermont Telephone Company</u>	\$12,256,492	<u>Infrastructure</u>
<u>Wildwood Programs, Inc.</u>	\$845,363	<u>Sustainable Adoption</u>

Table 18-5. Ohio ARRA Projects for Schools and Libraries

Grantee	Total Award	Type
<u>Com Net, Inc.</u>	\$30,031,849	<u>Infrastructure</u>
<u>Communication Service for the Deaf, Inc.</u>	\$14,988,657	<u>Sustainable Adoption</u>
<u>Connected Nation, Inc.</u>	\$6,856,399	<u>Sustainable Adoption</u>
<u>Horizon Telcom, Inc.</u>	\$66,474,247	<u>Infrastructure</u>
<u>Ohio Office of Information Technology</u>	\$7,025,762	<u>Broadband Data & Development</u>
<u>One Community</u>	\$18,701,771	<u>Sustainable Adoption</u>
<u>One Economy Corporation</u>	\$28,519,482	<u>Sustainable Adoption</u>
<u>OneCommunity</u>	\$44,794,046	<u>Infrastructure</u>
<u>Toledo-Lucas County Public Library</u>	\$2,163,655	<u>Public Computer Centers</u>
<u>University Corporation for Advanced Internet Development</u>	\$62,540,162	<u>Infrastructure</u>
<u>Zito Media Communications II, LLC</u>	\$6,136,904	<u>Infrastructure</u>

Table 18-6. Pennsylvania ARRA Projects for Schools and Libraries

Grantee	Total Award	Type
<u>Communication Service for the Deaf, Inc.</u>	\$14,988,657	<u>Sustainable Adoption</u>
<u>Executive Office of the Commonwealth of Pennsylvania</u>	\$28,784,014	<u>Infrastructure</u>
<u>ION Hold Co., LLC</u>	\$39,724,614	<u>Infrastructure</u>
<u>Keystone Initiative for Network Based Education and Research</u>	\$99,660,678	<u>Infrastructure</u>
<u>Mission Economic Development Agency</u>	\$3,724,128	<u>Public Computer Centers</u>
<u>One Economy Corporation</u>	\$28,519,482	<u>Sustainable Adoption</u>
<u>PA Department of Community and Economic Development</u>	\$7,356,301	<u>Broadband Data & Development</u>
<u>The City of Philadelphia</u>	\$6,362,129	<u>Public Computer Centers</u>
<u>The Urban Affairs Coalition</u>	\$11,804,015	<u>Sustainable Adoption</u>
<u>University Corporation for Advanced Internet Development</u>	\$62,540,162	<u>Infrastructure</u>
<u>Wireless Neighborhoods</u>	\$784,000	<u>Public Computer Centers</u>
<u>Zito Media Communications II, LLC</u>	\$6,136,904	<u>Infrastructure</u>

Table 18-7. Illinois ARRA Projects for Schools and Libraries

<u>Grantee</u>	<u>Total Award</u>	<u>Type</u>
<u>Board of Trustees of the University of Illinois</u>	\$22,534,776	<u>Infrastructure</u>
<u>City of Chicago</u>	\$8,974,283	<u>Public Computer Centers</u>
<u>City of Chicago</u>	\$7,074,369	<u>Sustainable Adoption</u>
<u>Communication Service for the Deaf, Inc.</u>	\$14,988,657	<u>Sustainable Adoption</u>
<u>DeKalb County Government</u>	\$11,864,164	<u>Infrastructure</u>
<u>Delta Communications, dba Clearwave Communications</u>	\$31,515,253	<u>Infrastructure</u>
<u>Illinois Department of Central Management Services</u>	\$61,895,282	<u>Infrastructure</u>
<u>MyWay Village, Inc.</u>	\$4,731,442	<u>Sustainable Adoption</u>
<u>Northern Illinois University</u>	\$46,114,026	<u>Infrastructure</u>
<u>One Economy Corporation</u>	\$28,519,482	<u>Sustainable Adoption</u>
<u>The Partnership for a Connected Illinois</u>	\$6,554,641	<u>Broadband Data & Development</u>
<u>University Corporation for Advanced Internet Development</u>	\$62,540,162	<u>Infrastructure</u>

- Federally funded strategic education initiatives:⁵⁸³
 - Race to the Top Program: A \$700 million grant was awarded to Florida on August 24, 2010 to implement comprehensive strategies for four central areas of education reform, including, “building data systems that measure student success, and inform teachers and principals about how they can improve instruction.” This award includes support for district LMS.⁵⁸⁴
 - \$10 million ARRA grant for enhancements to the Statewide Longitudinal Data System: The grant will be used to support technology system upgrades, provide more timely feedback to teachers for instructional improvement purposes, and enhance the accuracy, accessibility, and evaluation of programs. Grant funds also will be used to augment district technology initiatives, specifically LMS, as outlined in the state’s Race to the Top application.⁵⁸⁵

⁵⁸³ Ibid., 225.

⁵⁸⁴ Florida Senate, “School District Information Technology Procurement,” 7.

⁵⁸⁵ Ibid.

Despite the availability and success of the above programs, the lack of wiring within classrooms in many states continues to prevent many students and teachers from electronically sharing files and accessing the Internet at the classroom level. In the E-rate program, for example, on-premises wiring and equipment (e.g., LANS, servers, routers) necessary to bring connectivity to the classroom are eligible in the Internal Connections category. Generally, the cost of Internal Connections equipment (the only category where ownership is permitted) is much more expensive than the cost of the services in the Telecommunications and Internet Access categories. Further, E-rate rules prioritize annual funding such that all eligible requests for Telecommunications and Internet Access are funded first and then any remaining money funds Internal Connections requests. The practical result of the prioritization rules is that money runs out each year before all Internal Connections requests can be funded. Therefore, requests by applicants qualifying for lower discount percentages have never been funded.

19 Public Safety⁵⁸⁶

Below we provide a more detailed context for our policy recommendations regarding governance and centralization in Volume 1.

19.1 Florida Communication Information Technology Services Act⁵⁸⁷

19.1.1 DMS Responsibility for State Agency Law Enforcement Radio System and Interoperability Network⁵⁸⁸

DMS may acquire and administer a statewide radio communications system to serve law enforcement units of state agencies and to serve local law enforcement agencies through mutual aid channels. DMS is responsible for the design, engineering, acquisition and implementation of the system and for ensuring the proper operation and maintenance of shared system equipment. DMS is authorized to create and administer an interoperability network to enable interoperability between various radio communications technologies. DMS also is charged with planning, managing and administering the mutual aid channels in the radio communications system.

DMS's duties relative to the mutual aid channels and the interoperability network are to be carried out in conjunction with the Department of Law Enforcement and the Division of Emergency Management of the Department of Community Affairs. The mutual aid channels and interoperability system may be made available to federal, state, and local agencies for public safety and domestic security. The statewide radio communications system may be amended and enhanced as necessary to implement the interoperability network.

The eight-member Joint Task Force on State Agency Law enforcement Communication is created by the Act to advise the Department of agency needs relating to the statewide radio communications system. DMS provides technical support to the Task Force.

- DMS Responsibility for state agency law enforcement radio system and interoperability network⁵⁸⁹

⁵⁸⁶ Review of this section was requested January 11, 2011 from FDLE and the Public Safety Bureau at DMS, and timely received from William E. Smith of the Public Safety Bureau and Penny Kincannon of FDLE in time for final publication of this report. We appreciate and acknowledge the review of this section provided by FDLE and the Public Safety Bureau at DMS.

⁵⁸⁷ Questions about interpretation or applicability of these or other provisions of Florida law should be directed to competent legal counsel. The Act is codified at sections 282.701 – 282.711, Florida Statutes. Statutes cited were accessed at <http://www.leg.state.fl.us/statutes/>. Session laws cited were accessed at <http://laws.flrules.org/>. Note that definitions used in the Act are codified at Section 282.0041(1) Florida Statutes.

⁵⁸⁸ Florida Statutes Section 282.709.

⁵⁸⁹ Florida Statutes Section 282.7101.

DMS must develop and maintain a system of regional law enforcement communications. To that end, the Department must designate the regions. DMS must adopt rules and regulations for administering and coordinating the regional system. The Secretary of the Department, or designee, is the director of the regional system and may coordinate the activities of the system with other state agencies and local law enforcement agencies. A law enforcement communications system cannot be expanded or established without prior approval of DMS. To the extent that it is able, the Department of Law Enforcement is encouraged to assist DMS with development of the regional system.

19.2 Public Safety Networks

19.2.1 Introduction

Public safety communications networks can be characterized as either broadband or narrowband in nature. Public safety communication networks in all five states we examined are generally separate from data networks used for other state government purposes. These networks have a functional need to be more extensive than those for other state functions and to be highly integrated with local networks used for the same purposes. The characteristics of these networks are in many respects a result of the history of public safety communications systems composed of radio networks that have been used for decades by public safety agencies. For example, the nation's first statewide emergency radio network was established in Illinois in 1965.⁵⁹⁰

19.2.2 Narrowband Voice Systems

Existing public safety networks in Florida (as elsewhere) tend to be narrowband or voice-oriented. These networks include the radio systems currently in use by local jurisdictions for police, fire and emergency medical response; the Florida Statewide Law Enforcement Radio System (SLERS) network in use for state law enforcement agencies and partners; and the Florida Interoperability Network which is an interoperability solution to connect dissimilar radio systems. These narrowband systems are often supplemented by commercial wideband data services where available as an economic alternative to government-owned data system that can be cost prohibitive.⁵⁹¹ Narrowband voice public safety networks are governed under structures that are determined and administered by the local jurisdictions they serve.⁵⁹² Current radios used by law enforcement are more costly because the devices are ruggedized, durable, equipped with larger control buttons and features specific for public safety officials (emergency, scanning,

⁵⁹⁰ State of Illinois, *Statewide Communications Interoperability Plan*. (Illinois SCIP).

⁵⁹¹ Email from William E. Smith, Chief of Public Safety, Public Safety Bureau, Florida Department of Management Services to David Brevitz, Public Utility Research Center, University of Florida, dated January 21, 2011.

⁵⁹² Interview by David Brevitz and Herb Cash, Public Utility Research Center, University of Florida, with William E. Smith, Chief of Public Safety, Public Safety Bureau, Florida Department of Management Services and Bill Price, Department of Management Services, November 17, 2010.

shared functional talk group structure, etc.). They are designed to operate with 99+ percent reliability because public safety officers' lives depend on immediate voice communication. The radios are heavy with most of the weight in the battery. The battery is large in order to provide for reliable public safety usage at high power levels. Law enforcement personnel are familiar with the functionality and capability of these radios for narrowband voice communications, and it will therefore be hard to replace those devices with something entirely new or not as feature-capable. Public safety officers cannot risk being on the leading edge of untested or developing technologies and related equipment that will be deployed in critical or life threatening situations.⁵⁹³

19.2.2.1 Interoperability

The various narrowband radio systems in place for different jurisdictions in Florida (and in other states) frequently are incompatible and lack interoperability due to proprietary vendor standards and different frequency bands. This specialization to law enforcement based on differing vendor standards raises equipment costs. "Because of the specialized nature of much of the [radio] equipment, the nation's 50,000 public safety agencies pay \$2,500 to \$5,000 a unit for the current generation of rugged, hand-held radios that allow different departments to talk to each other. Only mass production of uniform broadband equipment is likely to bring down the costs, officials say."⁵⁹⁴

Problems caused by the lack of interoperability have been illustrated nationally by the bombing of the Murrah Federal Building in Oklahoma City and the attack on the World Trade Center.⁵⁹⁵ Similar difficulties occurred in Florida during "the ValuJet crash, Amtrak derailment and fires in 1997,"⁵⁹⁶ as well as during hurricanes Katrina and Rita.⁵⁹⁷ The Florida Interoperability Network (FIN) was developed and implemented post-9/11 with Department of Homeland Security grants. The "cloud" network which provides FIN connectivity is the MFN. FIN will continue to be in place for a long time—essentially as long as local jurisdictions in Florida continue to use incompatible narrowband radio systems. The FIN is governed by "the Domestic Security Oversight Council (DSOC) [which] is the executive policy advisory group chaired by the Commissioner of the Florida Department of Law Enforcement (FDLE) with the Director of Emergency Management (DEM) serving as the Vice-chairman. DSOC is comprised of heads of

⁵⁹³ Interview by David Brevitz, Herb Cash, and Mark Jamison, Public Utility Research Center, University of Florida, with Penny Kincannon and Joey Hornsby, Florida Department of Law Enforcement, December 3, 2010; and Interview by David Brevitz and Herb Cash Public Utility Research Center, University of Florida, with William E. Smith, Chief of Public Safety, Public Safety Bureau, Florida Department of Management Services and Bill Price, Department of Management Services, November 17, 2010.

⁵⁹⁴ Wyatt, "9 Years After 9/11, Public Safety Radio Not Ready."

⁵⁹⁵ Department of Management Services, "Florida's Interoperability Strategy."

⁵⁹⁶ Ibid.

⁵⁹⁷ Wyatt, "9 Years After 9/11, Public Safety Radio Not Ready."

state agencies that have a critical role in Florida's domestic security. Representatives from the RDSTFs and key members of federal, private sectors and professional associations make up the executive committee.”⁵⁹⁸

19.2.2.2 Statewide Law Enforcement Radio System (SLERS)

SLERS is Florida’s Statewide Law Enforcement Radio System that is a “single, unified [all digital] radio network that meets the radio voice communications needs of state law enforcement officers and other participating agencies throughout the state. . . . The goal of the Statewide Law Enforcement Radio System (SLERS) is to provide state law enforcement personnel with a shared radio system. The current system serves over 15,000 radios in patrol cars, boats, motorcycles and aircraft throughout the State.”⁵⁹⁹ The Joint Task Force (JTF) approved FDOT’s Road Rangers access into the 800MHz, SLERS in 2005 as a third-party subscriber. This SLERS access provides for Road Ranger direct communications with the Florida Highway Patrol Trooper and/or FHP’s seven (7) Regional Dispatch Centers.

SLERS is operated as a “public/private” partnership with Harris Corporation. Through this network, the State of Florida achieves: “effective interagency, interoperable communications; coordinated communications with local public safety entities; a viable solution to radio frequency congestion. . . .”⁶⁰⁰ SLERS was created under section 282.709 of the Florida Statutes and is managed by the DMS. Additionally, by the same Statute, “the Joint Task Force on State Agency Law Enforcement Communications (JTF Board) was established in DMS ...to advise the office [Department of Management Services] of member-agency needs for the planning, designing and establishment of the joint system.”⁶⁰¹

Note that despite the wireless nature of access to the network, all wireless networks significantly depend on the wireline network for transport between towers. SLERS and FIN both use MFN for transport. MFN also provides the network transport for the Criminal Justice Network (CJNet, which is described next) as operated by FDLE for public safety agencies in Florida.⁶⁰² MFN meets stringent public safety requirements for performance and security.

19.2.3 Broadband Networks

19.2.3.1 Criminal Justice Network (CJNet)

FDLE has five programs, one of which is Criminal Justice Information, which in turn is

⁵⁹⁸ Department of Management Services, “FIN Implementation.”

⁵⁹⁹ Department of Management Services, “System Description.”

⁶⁰⁰ Ibid.

⁶⁰¹ Department of Management Services, “Statewide Law Enforcement Radio System (SLERS).”

⁶⁰² Interview by David Brevitz, Herb Cash, and Mark Jamison, Public Utility Research Center, University of Florida, with Penny Kincannon and Joey Hornsby, Florida Department of Law Enforcement, December 3, 2010.

composed of two service areas: Prevention and Crime Information and Network Services.⁶⁰³ The Prevention and Crime Information Services service area is the central repository of criminal history records for the state of Florida. “FDLE maintains the central repository of criminal history records, as well as “hot files” that provide such data as wanted and missing persons, stolen vehicles, guns and property, and domestic violence injunctions. These databases are made accessible to all criminal justice agencies statewide through the Florida Crime Information Center (FCIC), which links agencies to the FBI’s National Crime Information Center (NCIC). FDLE’s Biometric Identification System (BIS) provides immediate positive identification of fingerprints of arrested persons and an automatic update of the criminal history files.”⁶⁰⁴

FDLE’s Network Services provides the computer hardware, software programming and communications technology necessary to maintain and share criminal justice information across a communications network for Florida’s more than 760 criminal justice agencies.⁶⁰⁵ “Law enforcement and other criminal justice agencies have access to the state’s criminal justice databases 24 hours a day, 365 days a year.”⁶⁰⁶

Network Services supports CJNet, which provides a secure network for criminal justice agencies to access state and federal warrants and computerized criminal history records; Falcon; fingerprint data; driver license data and photos; vehicle registration; Corrections incarceration data; key intelligence databases; relevant publications, and many other systems and related information sharing links. CJNet was put in place in the mid-1990’s with the focus of sharing of information among criminal justice jurisdictions and agencies, not to replace agencies’ networks. CJNet supports all criminal justice agencies in Florida and is the gateway to other state, federal and international criminal justice agencies and information.⁶⁰⁷ CJNet is governed by the Criminal Justice Information Services council. CJNet is a “fully meshed” network such that every agency can talk to another over MFN. Funding for CJNet connectivity is included in FDLE’s base budget, but these connections are dependent on annual appropriations.⁶⁰⁸

CJNet was the largest user on the State of Florida’s frame relay network which preceded MFN. FDLE went from 56kb to T-1 in concert with changeover to MFN.⁶⁰⁹

⁶⁰³ Florida Department of Law Enforcement, *Statement of Agency Organization and Operation*, 4.

⁶⁰⁴ Ibid.

⁶⁰⁵ Florida Legislature, “Department of Law Enforcement, Criminal Justice Information Services.”

⁶⁰⁶ Ibid.

⁶⁰⁷ Florida Department of Law Enforcement, *Statement of Agency Organization and Operation*, 4

⁶⁰⁸ Interview by David Brevitz, Herb Cash, and Mark Jamison, Public Utility Research Center, University of Florida, with Penny Kincannon and Joey Hornsby, Florida Department of Law Enforcement, December 3, 2010.

⁶⁰⁹ Interview by David Brevitz, Herb Cash, and Mark Jamison, Public Utility Research Center, University of Florida, with Penny Kincannon and Joey Hornsby, Florida Department of Law Enforcement, December 3, 2010.

19.2.3.2 Mobile Broadband in Florida

Broadband data communication for public safety in Florida is generally provided using commercial providers, including the MFN and the AirCard device provided by SUNCOM for use with laptop computers.⁶¹⁰ Vehicles and officers are equipped with “hardened” laptop computers which access wireless broadband networks via the AirCard Service,⁶¹¹ or similar service as procured from a source outside of SUNCOM (such as other local arrangements for local jurisdictions). AirCard Service is provided under contract with three providers: AT&T Mobility; Sprint; and Verizon. AirCard service provides access to the state network; direct access to the Internet; unlimited data rate plans; required hardware; and without end user term agreements.⁶¹² 3G/4G Aircard Service is also available through Sprint.⁶¹³ Law enforcement officials have become very accustomed to the benefits of using mobile broadband for their work, in fact this technology has been “a god send” for public safety.⁶¹⁴ Speed of the broadband connection has been slow but is improving significantly with commercial wireless network growth and deployment of 3G and 4G. Broadband speeds with the AirCard will be location-specific in the same fashion as any other consumer.

One important consequence of expanding use of mobile broadband data is that the exclusive reliance on voice communication is being reduced through application of technology. For example, an officer would have previously radioed in a license plate number and waited for a voice response on the vehicle registration. Instead, this is currently performed faster and more accurately, via the laptop in the officer’s vehicle. A further consequence is the personnel cost for some operations is reduced since volumes of certain tasks are being handled via database queries rather than via voice communication.⁶¹⁵

19.2.3.3 Nationwide Interoperable Public Safety Wireless Network

A call for greater use of broadband technology in public safety networks was made in the FCC’s National Broadband Plan goal to “create a Nationwide Interoperable Public Safety Wireless Broadband Communications Network. Broadband technologies will give first responders new

⁶¹⁰ Department of Management Services, “Wireless Data Services: AirCard.”

⁶¹¹ AirCard is used by state law enforcement agencies, and is also available to cities and counties under “opt in” provisions of Chapter 282.

⁶¹² Department of Management Services, “Wireless Data Services: AirCard Features/Options.”

⁶¹³ Department of Management Services, “3G/4G Unlimited Connect Plan.”

⁶¹⁴ Interview by David Brevitz and Herb Cash, Public Utility Research Center, University of Florida, with Mark Zadra, Assistant Commissioner; Penny Kincannon, CIO; Mark Perez, Special Agent in Charge, Investigations & Forensic Science Program; Tal Whiddon, Inspector, Statewide Technical Operations, Investigations & Forensic Science Program; and Joey Hornsby; Florida Department of Law Enforcement, January 6, 2011.

⁶¹⁵ Interview by David Brevitz and Herb Cash, Public Utility Research Center, University of Florida, with William E. Smith, Chief of Public Safety, Public Safety Bureau, Florida Department of Management Services and Bill Price, Department of Management Services, November 17, 2010.

tools to save American lives. The nation needs a nationwide public safety broadband wireless network that allows first responders nationwide to communicate with one another at all times and without delay.”⁶¹⁶ According to the FCC:

Unfortunately, the U.S. has not yet realized the potential of broadband to enhance public safety. Today, first responders from different jurisdictions and agencies often cannot communicate during emergencies. Emergency 911 systems still operate on circuit switched networks. Similarly, federal, Tribal, state and local governments use outdated alerting systems to inform the public during emergencies.⁶¹⁷

The National Broadband Plan recommends creation of “a nationwide interoperable public safety wireless broadband communications network.”⁶¹⁸ The FCC identifies necessary tasks, steps and actions to support creation of a nationwide interoperable public safety wireless broadband communications network on pages 314 – 320 of the National Broadband Plan. The National Broadband Plan vision for Public Safety Wireless Broadband centers on ensuring “that users of the public safety broadband spectrum have the capacity and service they require for their network” and leveraging commercial technologies.⁶¹⁹

The leveraging of commercial technologies enables “capture [of] economies of scale and scope.” In the words of the FCC:

There are significant benefits, including cost efficiencies and improved technological advancement, if the public safety community can increasingly use applications and devices developed for commercial wireless broadband networks. Ultimately, this system must be flexible, allowing public safety entities to forge incentive-based partnerships with commercial operators and others. Under this approach, the public safety licensee(s) is afforded the flexibility to enter into agreements with commercial partners for construction and operation of their 700 MHz network.⁶²⁰ . . .

The emerging consensus of the public safety community and carriers is that 700 MHz networks will use the Long Term Evolution (LTE) family of standards. The FCC should consider designating this standard. A consistent air interface creates a greater likelihood of interoperability between the public safety and commercial

⁶¹⁶ Federal Communications Commission, *National Broadband Plan*, “Broadband and Public Safety.”

⁶¹⁷ Federal Communications Commission, *National Broadband Plan*, Chapter 16, Public Safety, 313.

⁶¹⁸ *Ibid.*

⁶¹⁹ *Ibid.*, 314.

⁶²⁰ Federal Communications Commission, *National Broadband Plan*, Chapter 16, Public Safety, 314, including footnote 1.

D block networks. It will facilitate roaming between networks to improve coverage and access for public safety and commercial customers. In addition, a consistent air interface will encourage a larger number of potential users and allow public safety entities to benefit from commercial economies of scale that otherwise would not exist.⁶²¹

Since the FCC is responsible for allocating and assigning radio spectrum as a resource to be used in the public interest, it is able to provide spectrum capacity for public safety mobile broadband use. “On July 31, 2007, the FCC adopted a Report & Order approving the issuance of a single nationwide license for 10 MHz of 700 MHz public safety spectrum re-designated for broadband use and the creation of a public safety-commercial partnership to deploy a nationwide public safety-grade broadband network.”⁶²² The Order specified the requirements for the Public Safety Broadband Licensee (PSBL) and its commercial partner. In November 2007, the FCC selected the Public Safety Spectrum Trust Corporation (PSST) to be the PSBL. PSST is a nonprofit 501(c)3 organization.⁶²³ The original direction of the FCC was to obtain the commercial partners for the deployment of the public safety network via spectrum auction, but this path failed when the bidding proved inadequate.

19.2.3.4 DMS Waiver Request

One implication of the FCC’s original approach to providing the public safety broadband network is the rules associated with that approach remain in place and affect current deployments. DMS has filed a Request for Waiver of these rules on behalf of the State of Florida, stating:

The current [FCC] rules envisioned that the public safety broadband network would be deployed under a public/private partnership by the winner of the adjacent “D block” spectrum in the 758-763/788-793 MHz portion of the 700 MHz band. Unfortunately, auction of the D block spectrum failed, introducing significant delays in the plan. The rules that remain on the books two years later severely limit and discourage deployment by state or local governments, the very entities public safety spectrum should serve. Under these rules, the D block licensee will have the “exclusive right to build and operate the Shared Wireless Broadband Network.” For this reason, a number of public safety entities have requested a waiver of the rules to allow deployment in the PSST block of spectrum and the Commission previously granted twenty-one of these waiver petitions.⁶²⁴

⁶²¹ Ibid., 315.

⁶²² Public Safety Spectrum Trust, “A Brief History of Public Safety Communications.”

⁶²³ Ibid.

⁶²⁴ Department of Management Services, *Request for Waiver of the Commission’s Rules to Allow Establishment of a*

The City of Pembroke Pines recently received such a waiver from the FCC, and the State of Florida through DMS will coordinate its deployment to avoid conflicts between these systems.⁶²⁵ Also, “the State of Florida understands that it must enter into a spectrum agreement with the Public Safety Broadband Licensee, i.e., the Public Safety Spectrum Trust (PSST).”⁶²⁶ DMS notes that by “enabling early deployment in this band, we take a major step towards development of a nationwide interoperable public safety broadband wireless network.”⁶²⁷

“State of the art voice, data and video communications is essential for ‘first preventers’ and first responders in Florida.”⁶²⁸ “[T]he instant availability of criminal and other databases to officers in the field is extremely important. Once authorized and deployed, a State of Florida public safety broadband system will provide this access.”⁶²⁹

The state envisions a multitude of uses for the broadband network, once it is deployed and some preliminary experience is gained in its use. Examples of these applications include:

- Fast access to multiple databases in the field
- Transfer of images to/from public safety personnel in the field
- Video for surveillance and remote monitoring
- Automatic vehicle location
- Mapping and GIS
- Next generation dispatch functions

These are merely some of the applications the state anticipates for a broadband network. Further, it is the state’s experience that once a communications system is in place, public safety personnel find creative ways to enhance operations that may not have been envisioned at the outset.⁶³⁰

FDLE has mobile applications it would like to accomplish, and “700MHz might be the answer.” Those applications include: delivery of training to mobile device; monitoring of incidents via streaming video (which would be very capacity- and location- dependent); sharing of crime scene information more rapidly via mobile device. The coverage footprint will be the key. The technology will be required to provide for advance authentication, as law enforcement

700 MHz Interoperable Mobile Public Safety Broadband Network, 5.

⁶²⁵ Ibid., 1.

⁶²⁶ Ibid., 6.

⁶²⁷ Ibid.

⁶²⁸ Ibid., 2.

⁶²⁹ Ibid., 4.

⁶³⁰ Ibid., 5-6.

communications must be completely secure and encrypted.⁶³¹ The Fish and Wildlife Conservation Commission is also an “extremely mobile agency.” FWC has approximately 720 sworn officers and is the largest such agency in the world.⁶³²

19.2.3.5 Development of Nationwide Interoperable Public Safety Wireless Networks using Commercial Partners

As work continues on implementation of the vision of using commercial partners, certain issues have become obvious. If commercial partners will build and operate this network, those operators will expect to be paid appropriate amounts for providing that network offset by resources provided by the public safety entities toward construction of that network, *e.g.*, tower and/or site space, and grant funding. A further offset would be if the commercial providers are permitted to put their own customers onto that network, but this would require “preemption” procedures whereby public safety entities could kick off other users of the network in the event of an emergency to preserve all capacity for public safety use as intended. A significant complicating issue is that the network is not in place, or in use, and no partner entity has good information on utilization. Neither public safety entities nor commercial providers know what capacity will be needed for public safety use and, by obverse, how much capacity the commercial provider would be able to use for its other customers.⁶³³ The FCC’s plan for this is that “once the new network is able to support ‘mission-critical’ voice communications, the FCC should evaluate the spectrum requirements necessary to ensure adequate capacity for that use.”⁶³⁴ These issues are significant. One benefit of using applications and devices developed for commercial wireless networks is that it moves away from vendor specific and proprietary systems and technologies which have been the norm in public safety communications systems. Such systems and technologies are considered to be more expensive. However, there may be market limitations to development of devices for public safety use with commercial economies of scale.

As long as public-safety broadband radio spectrum occupies a unique band class [band class 14], it will have only devices that are specifically designed to satisfy its market. Because there will be a limited vendor community as a result, there will be less competition and the nonrecurring development costs will be higher on

⁶³¹ Interview by David Brevitz, Herb Cash, and Mark Jamison, Public Utility Research Center, University of Florida, with Penny Kincannon and Joey Hornsby, Florida Department of Law Enforcement, December 3, 2010.

⁶³² Interview by David Brevitz, Public Utility Research Center, University of Florida with Kevin Patten, Office of Information Technology, Florida Fish and Wildlife Commission, September 8, 2010.

⁶³³ Interview by David Brevitz and Herb Cash, Public Utility Research Center, University of Florida, with Mark Zadra, Assistant Commissioner; Penny Kincannon, CIO; Mark Perez, Special Agent in Charge, Investigations & Forensic Science Program; Tal Whiddon, Inspector, Statewide Technical Operations, Investigations & Forensic Science Program; and Joey Hornsby; Florida Department of Law Enforcement, January 6, 2011.

⁶³⁴ Federal Communications Commission, *National Broadband Plan*, Chapter 16, Public Safety, 315.

a per-device basis. This means that the promise of leveraging commercial economies of scale isn't realized yet. ... we know [future devices will] cost more than current smart phones. The question is how much more?⁶³⁵

The DMS Mobile Communication Services ITN looks toward the development of the new nationwide public safety network. “The Division [of Telecommunications] has been investigating and planning for the evolution of the public safety wireless network considering the feature and cost benefits of migration to standards based mobile broadband network infrastructure and equipment.”⁶³⁶ The DMS procurement of Mobile Communication Services seeks to use that procurement to potentially “fill gaps” in the public safety wireless network:

Current proposals before Congress and the Federal Communications Commission anticipate using technologies for public safety telecommunications that are similar [to] those offered by the Respondent in response to this ITN (i.e. public safety officials may ultimately use devices similar to those used by consumers instead of traditional public safety radios in use today). Entities like DivTel and its public safety partners, expect to obtain usage rights in 700 megahertz bands for this purpose. To deploy public safety networks using these bands, DivTel anticipates developing new procurement vehicles

that either seeks a comprehensive public safety network or components thereof that will be assembled by DivTel into a comprehensive network. However, the magnitude of a statewide public safety network means future respondents will likely offer incomplete geographic coverage. DivTel is seeking, through this ITN, a commitment from the Respondent to offer assets and services at fair prices to complete this future public safety telecommunications network. The Respondent shall provide a brief description of the assets and services that may aid DivTel's effort to complete a future public safety telecommunications network and indicate the Respondent's willingness to provide them.⁶³⁷

19.2.3.6 Public Safety Network Governance

The 700Mhz public safety broadband network is a “greenfield” opportunity for efficiency. “The 700 MHz broadband effort has presented a paradigm shift for public safety agencies, critical infrastructure industries, non-governmental organizations, commercial wireless carriers, land-based network providers, and government to accomplish the purpose of the network in a

⁶³⁵ Ross, “The Truth about LTE,” 43.

⁶³⁶ Department of Management Services, *Request for Waiver of the Commission's Rules to Allow Establishment of a 700 MHz Interoperable Mobile Public Safety Broadband Network*, 3.

⁶³⁷ Department of Management Services, *Invitation to Negotiate for Mobile Communication Services*, 46.

coordinated effort.”⁶³⁸ “The public safety broadband network offers a new opportunity to achieve advanced interoperability now.”⁶³⁹

Governance structure is crucial at the inception. “Lessons learned from past public safety efforts have taught us the importance to establish governance, collaborate, plan, and coordinate before implementing the technology—particularly for interoperable communications.”⁶⁴⁰ “Governance is of the utmost importance in light of various concerns and objectives between the commercial interests of manufacturers, integrators, network operators and public safety.”⁶⁴¹

In Florida, DMS recommends the cooperative governance approach of the Florida Executive Interoperability Technology Committee (FEITC) that is co-chaired by DMS’s DivTel and the Department of Emergency Management.⁶⁴² “The FEITC is expected to encompass all aspects of the public safety networks coordination for planning and management with its statewide oversight for all public safety agencies at all levels of government as well as to include the benefit of [critical infrastructure industries] and [non-government organizations].”⁶⁴³

Incorporation of 700 MHz public safety broadband into the communications network serving public safety organizations in Florida should be done in the context of the Statewide Communication Interoperability Plan (SCIP), according to DMS.⁶⁴⁴ Public safety mobile broadband should be included in the SCIP using the following comprehensive review process:

1. “Review past inter-governmental governance approaches in managing spectrum to ensure common understanding and appreciation of what works well and what does not within each state
2. Review the 700 MHz FCC spectrum plans, issues, requirements, objectives and priorities, the National Broadband Plan to create awareness and understanding
3. Inventory current systems, capabilities, coverage and plans; LMR, P25 including current and planned budgets. This will baseline infrastructure and budget understanding for potential leverage points.
4. Develop 700 MHz public safety priorities for the state; define what the goals and priorities of the services will be once the network(s) are built out.
5. Develop the state’s approach to inter-governmental 700 MHz governance that would

⁶³⁸ Department of Management Services, *Comments on the FCC 700 Waiver Order Filing Questions, In Re: 700 MHz Interoperable Broadband Public Safety Network*, 3.

⁶³⁹ Federal Communications Commission, *National Broadband Plan*, Chapter 16, Public Safety, 315.

⁶⁴⁰ *Ibid.*, 1.

⁶⁴¹ *Ibid.*

⁶⁴² *Ibid.*, 2 and 4.

⁶⁴³ *Ibid.*, 4.

⁶⁴⁴ Department of Management Services, *Comments on the FCC 700 Waiver Order Filing Questions, In Re: 700 MHz Interoperable Broadband Public Safety Network*, 5.

include:

- a. Deployment criteria
- b. Funding strategies and business cases
- c. Training requirements
- d. Equipment procurement requirements and procurement strategies”⁶⁴⁵

Each state in the country has developed a SCIP that was to be submitted to the Department of Homeland Security in 2007 and which was to be incorporated into the National Emergency Communications Plan. A round of implementation report updates was to be completed in mid-2009 and alignment with the national plan was to be completed by the end of 2010. Eligibility for certain grant funds is conditioned on the existence and quality of the state plan and progress toward implementation. Review of the initial state plans by DMS included the identification of a number of common elements and best practices in those plans. Specifically in regard to technology, common strategies included:

- Conducting a statewide capabilities assessment including critical communications equipment and related interoperability issues.
- Developing or enhancing strategic technology reserves.
- Developing shared statewide or regional radio systems supporting multiple federal, state, and local agencies.
- Installing statewide or regional fixed-interoperability channel infrastructure.⁶⁴⁶

Other national efforts have directly spurred states to develop modern public safety communication networks. One such program is the Department of Homeland Security’s SAFECOM, which supports state and local governments’ development of public safety communications in a variety of ways. The program is situated within the Department’s Office of Emergency Communications (OEC) and Office for Interoperability and Compatibility. SAFECOM provides support to federal, state and local emergency response agencies through research, development, testing and evaluation, guidance, tools, and templates on communications-related issues.⁶⁴⁷ The focus of SAFECOM is to assist agencies as they improve emergency response through more effective and efficient interoperable⁶⁴⁸ wireless

⁶⁴⁵ Ibid.

⁶⁴⁶ U.S. Department of Homeland Security, *National Summary of Statewide Communication Interoperability Plans (SCIPs)*, 4. (National SCIP Summary).

⁶⁴⁷ US Department of Homeland Security, “About SAFECOM,”

<http://www.safecomprogram.gov/SAFECOM/about/default.htm>, accessed September 25, 2010.

⁶⁴⁸ According to the federal Department of Homeland Security, “In general, interoperability refers to the ability of emergency responders to work seamlessly with other systems or products without any special effort. Wireless communications interoperability specifically refers to the ability of emergency response officials to share

communications.

19.3 Public Safety Networks in Other States

States we examined are at various stages of implementing interoperable statewide public safety communication systems. For example, Pennsylvania is nearing completion of its statewide telecommunications network for public safety agencies. The Pennsylvania Statewide Radio Network (PA-STARNet) is under the authority of the Office of Public Safety Radio Services (OPRS), a part of the Governor’s Office of Administration. In addition to managing the radio system, the Office has been assigned the lead role in promoting public safety communication interoperability in the state.⁶⁴⁹ PA-STARNet is owned and operated by the Commonwealth. Agencies and county or local governments can obtain services and products from PA-STARNet’s vendors using the state contract.

In Pennsylvania, a centrally operated and managed Commonwealth communication system was begun in the mid-1990s, well before the current national effort began. At that time, the radio system used by the state police and other agencies needed to be replaced. Three key decisions guided that replacement:

- Rather than replace existing systems one-by-one and allow them to remain under agency control, the Commonwealth elected to deploy a single system, with transmitters and receivers statewide, that is connected and managed centrally through a microwave network.
- The new system would support both voice and data communications, using Voice over Internet Protocol (VoIP) technology.
- The design, development, operation and support of the new system would be the responsibility of a single office dedicated to that purpose, charged with delivering wireless voice and data services to benefit all commonwealth agencies.⁶⁵⁰

The current PA-STARNet infrastructure includes high-profile data communication sites across

information via voice and data signals on demand, in real time, when needed, and as authorized. For example, when communications systems are interoperable, police and firefighters responding to a routine incident can talk to each other to coordinate efforts. Communications interoperability also makes it possible for emergency response agencies responding to catastrophic accidents or disasters to work effectively together. Finally, it allows emergency response personnel to maximize resources in planning for major predictable events such as the Super Bowl or an inauguration, or for disaster relief and recovery efforts.” U.S. Department of Homeland Security, “Interoperability.”⁶⁴⁹ Pennsylvania Office of Administration, *Broadband Strategy for the 21st Century*.

See also, Commonwealth of Pennsylvania, *Statewide Communications Interoperability Plan*.

⁶⁵⁰ Commonwealth of Pennsylvania, *2010 NASCIO Awards, Information Communications Technology Innovation, Pennsylvania STARNet*.

the state, with compact, unobtrusive microcell stations providing supplementary coverage; a system network backbone that links sites through a statewide high-availability microwave network, with secure network access; and seven regional operations centers and a network operations center providing voice and data communications control and network monitoring and administration. A remotely located, backup network operations center is used for recovery and continuity.⁶⁵¹

In Ohio, the multi-agency radio communication system (MARCS) is an 800 MHz radio and data network that provides statewide interoperability to subscribers throughout Ohio and in a 10-mile radius outside the state. MARCS operates on three system components: mobile voice; mobile data; and computer-aided dispatch.⁶⁵² MARCS is available to public safety agencies via a state contract administered by the Office of Information Technology. “MARCS is used by more than 700 local and federal first responder agencies, as well as border areas in contiguous states. Users include 213 fire agencies, 128 police agencies, 80 emergency medical service agencies (EMS), 89 emergency management agencies (EMA), 17 state agencies, the Federal Bureau of Investigation (FBI), the Bureau of Alcohol, Tobacco, Firearms and Explosives (ATF), the U.S. Border Patrol, the U.S. Fish and Wildlife Service, and the High Intensity Drug Trafficking Area (HIDTA), part of the Drug Enforcement Administration. In all, there are 1,292 subscribing agencies . . .” in Ohio and neighboring states.⁶⁵³ A long-term goal was interconnecting MARCS with countywide public safety systems. Another long-term goal was establishing an IP-based backbone network that would interconnect strategic locations within Ohio. The network also would provide for last-mile connectivity.⁶⁵⁴ Ohio is part of the Midwest Public Safety Communications Consortium that includes neighboring states of Indiana, Michigan, and Kentucky, as well as Illinois.⁶⁵⁵

New York has a Statewide Interoperability Program; initially conceived as a statewide network, the focus was reconfigured after the state terminated a vendor contract for unsatisfactory performance. The network is now conceived as a network of regional networks.⁶⁵⁶ The State Interoperability Program Office is responsible for planning and coordinating the state’s 700 MHz license spectrum with neighboring states (Vermont, Massachusetts, Connecticut, New Jersey, and Pennsylvania). This work was ongoing during 2009 and continued throughout 2010. It will provide a multi-state plan to facilitate interoperability by harmonizing 700MHz channel plans

⁶⁵¹ Pennsylvania Statewide Radio Network, “Overview and Fact Sheet.”

⁶⁵² Ohio.gov., “MARCS Services.”

⁶⁵³ Multi-Agency Radio Communications System, *MARCS Task Force Report*, 7

⁶⁵⁴ State of Ohio, *Statewide Communications Interoperability Plan*, 58 and 60.

⁶⁵⁵ U.S. Department of Homeland Security, *National Summary of Statewide Communication Interoperability Plans (SCIPs)*.

⁶⁵⁶ Statewide Wireless Network Advisory Council, *2009 New York State Statewide Wireless Network Annual Report*, 4.

between the states.⁶⁵⁷

Currently, Illinois has both a radio system, STARCOM21, and a wireless network, IWIN, that are used for public safety and law enforcement purposes. STARCOM 21 is a 700/800 MHz, interoperable, digital, trunked voice radio network. Like Florida's SLERS, STARCOM21 is a public-private partnership. STARCOM21 is owned and operated by Motorola, Inc. and leased to the State of Illinois for its use. The network is available to public safety agencies at all levels of government, as well as to non-governmental bodies subject to state approval and contractual requirements. IWIN was initiated in 1998 and has been operational since 2000. The network utilizes mobile data computers with code division multiple access modems and proprietary software to send and receive via appropriately equipped cellular towers and communications interfaces. IWIN is managed and supported by the Illinois Department of Central Management Services and is available to approved, Illinois state and local government agencies through the state contract. IWIN provides approved agencies with access to a number of law enforcement data systems.⁶⁵⁸

19.4 Next Generation E911 Systems in Florida

Next Generation 911 emergency communications systems are an advancement above the Enhanced 911 (E911) emergency communications systems that are widely deployed today. E911 is a “telephone system service which includes network switching, database and Public Safety Answering Point [PSAP] premise elements capable of providing automatic location identification data, selective routing, selective transfer, fixed transfer, and a call back number for 911 calls.”⁶⁵⁹ Next Generation 911 is “the next advancement in Enhanced 911 systems designed to handle voice, data, and video developed on a standardized managed IP based platform for routing and delivery of 911 emergency requests (calls or messages) from a variety of devices and services, including text messaging and telematics, to the appropriate PSAP and resolve interoperability issues to provide the capability of an emergency communications network.”⁶⁶⁰ The Public Safety Answering Point (PSAP) is the “public safety answering center that receives incoming 911 calls and dispatches appropriate public safety agencies to respond to the calls.”⁶⁶¹

⁶⁵⁷ The FCC granted New York State and New York City conditional waivers in May 2010 to move forward with deployment of the public safety broadband networks using 700 MHz. See New York State, “FCC Grants Conditional Approval.”

⁶⁵⁸ IWIN permits users to access LEADS (Law Enforcement Agencies Data System); NCIC (National Crime Information Center); SOS (Secretary of State); NLETS (National Law Enforcement Telecommunications System); and CHRI (Criminal History Record Information).

⁶⁵⁹ Department of Management Services, *Request for Proposal for NG-911 Statewide Routing Development*, Definitions, 3.

⁶⁶⁰ Ibid.

⁶⁶¹ Ibid.

Table 19-1 compares E911 and NG-911.

Table 19-1. Comparison of E911 and NG-911

<u>Today's 9-1-1</u>	<u>Next Generation 9-1-1</u>
Virtually all calls are voice calls via telephones over analog lines	Voice, text or video information, from many types of communications devices, sent over
Data transferred via voice	Advanced data sharing is automatically performed
Callers manually routed through legacy selective routers, limited forwarding/backup capability	Physical location of PSAP becomes immaterial, callers routed automatically based on geographic location, enhanced backup capabilities
Limited ability to handle overflow situations, callers could receive busy signal	PSAPS able to control call congestion treatment, including dynamically rerouting callers

Source: DMS.

The Department of Management Services has released a Request for Proposal (RFP) for “NG-911 Statewide Routing Development,”⁶⁶² as a step toward development of NG-911 on a statewide basis. The RFP provides useful background information on NG 911.

19.4.1 Background for NG-911 Statewide Routing Development⁶⁶³

Currently there are four Internet Protocol (IP) regional routing projects funded by the Florida E911 Board and *Ensuring Needed Help Arrives Near Callers Employing 911 Act (ENHANCE 911 Act)*. These four projects have been identified as North Florida Pilot Routing Project, Okaloosa/Walton Routing Project, Lake/Orange Routing Project, and Martin/St. Lucie Routing Project. The evolution of a statewide NG-911 system must incorporate these regional routing projects and establish an Enterprise IP network of integrated NG-911 networks.

The Florida E911 Board programs have funded numerous grant projects to upgrade and replace existing PSAP enhanced 911 systems to IP based E911 systems. Not all of the Florida PSAPs have been upgraded to NG-911 systems. Through this RFP, DMS will develop the statewide routing system to enable counties to connect IP ready E911 systems. The design of PSAP E911

⁶⁶² Department of Management Services, *Request for Proposal for NG-911 Statewide Routing Development*.

⁶⁶³ *Ibid.*, 3-4.

call taking CPE is explicitly outside of this initiative scope, with exception of firewalls, session controllers, routers and gateways needed to connect to PSAP E911 systems. Future projects will address remaining PSAP equipment and diverse transport for the 911 PSAP for 911 calls and E911 systems.

All E911 communications are to be included in the packet-based voice and data system including legacy landline, broadband VoIP, wireless cellular service, IP services and emerging technology services.

The DMS, DivTel currently operates MFN, a statewide Internet Protocol (IP) network backbone. This IP network is currently available to provide the infrastructure and network access for all public agencies throughout Florida. This enterprise infrastructure is based on a MPLS technology. MFN also provides service elements such as network core, local loop access, CPE, security, network management tools, design and engineering for a complete turn-key solution with flat-rate pricing statewide. MFN further provides a robust network with stringent service level requirements and enhanced security.

19.4.2 Overview of Desired NG-911 Statewide Routing Development⁶⁶⁴

Through this RFP, DMS seeks the contractual services of an independent design team of one or more persons, with consultant engineering skills, to develop a state level Emergency Services Internet Protocol network (ESInet). DMS will not consider proposals from entities that currently offer NG911 system equipment or services other than consultant engineering services. The design must be based on requirements analysis rather than existing solutions available in the marketplace.

DMS was awarded a federal grant under the *ENHANCE 911 Act* to develop a contract to implement a state level ESInet to interconnect Florida's PSAPs and regional IP routing systems for the receipt and delivery of 911 calls. DMS's right to incur reimbursable costs under the *ENHANCE 911 Act* grant program expires on September 30, 2012. The consultant engineering services contractor selected by this RFP will work with MFN SUNCOM network engineers and statewide E911 engineers to develop a statewide service contract. Engineering will address enhanced 911 call-routing, database, transport, interoperability, security, diverse-routing, redundancy and related issues. NG-911 issues involving Session Initiation Protocol, text messaging and video transport are design criteria.

The Florida NG-911 System will be aligned with the National Emergency Number Association (NENA) Functional and Interface Standards for Next Generation 911, current version, (i3) NENA 08-002 and the USDOT NG-911 Documents, the IETF emergency-calling-protocol standards applied to specific NG-911 requirements of the ESInet. The statewide migration will

⁶⁶⁴ Ibid., 4-5.

require DMS, Florida counties and the regional routing systems to coordinate and collaborate to form a statewide ESInet, and to transition regional PSAPs to the Florida NG-911 System.

Figure 19-1⁶⁶⁵ shows the network that is visualized to support NG-911 Statewide Routing:

Figure 19-1. NG-911 Network Using MFN

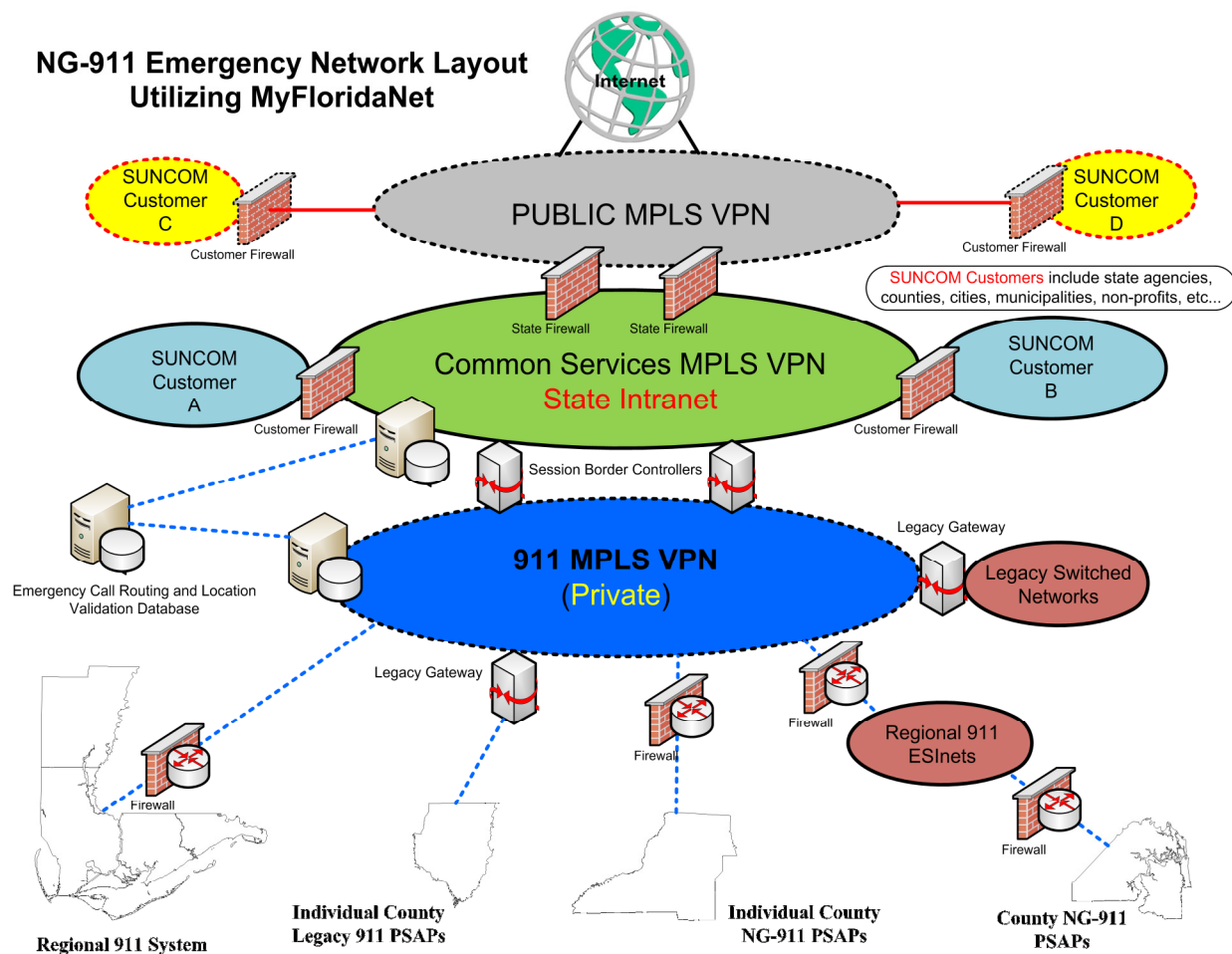

Source: Department of Management Services, Request for Proposal for NG-911 Statewide Routing Development.

⁶⁶⁵ Ibid., 5.

19.5 Financing Public Safety Networks

Unlike other functional areas of state networks, public safety networks have been able to use significant amounts of federal grant funds, coupled with appropriations of state funds, to put in place the necessary infrastructure for modernized communication systems. Identifying an ongoing source of funding for interoperable systems is one of the tasks that states must complete as they develop and implement state communication plans. Some best practices identified by the Department of Homeland Security in its summary of the state plans submitted in 2009 were found in the states we examined. Specifically:

- Ohio was one of four states highlighted for creation of user fees and rate-recovery programs to collect funding by charging a fee to subscribers on the statewide or region-wide systems.
- Also in Ohio, individual county municipal funds including tax levies are used as alternatives to fund the implementation and maintenance of shared regional and countywide systems.
- Pennsylvania plans to utilize funds derived from the operating budget of the Office of Public-Safety Radio Services (OPRS) for long-term financing of the communications system. The state also will continue to utilize grant funds and to distribute them to counties as needed. Bonds and county general funds may be available for local entities to use for the costs of upgrades and future long-term interoperability funding such as capital replacement, repair, systems upgrades, and ongoing training.⁶⁶⁶

The Ohio MARCS has statutory authority for funding of the system’s annual operating budget which is approximately \$11 million. “The Ohio Revised Code currently provides funding for MARCS from users’ fees collected and distributed by three different intermediaries, each for a specific purpose. Section 4501.16 provides for a MARCS maintenance fund, which ‘shall consist of moneys received by the state highway patrol from users of the multi-agency radio communications system (MARCS). The fund shall be used to provide maintenance for MARCS-related equipment located at both the MARCS facilities and tower sites.’ Section 4501.28 provides for a MARCS operations fund, which ‘shall consist of moneys received by the emergency management agency established under section 5502.22 of the Revised Code from users of the multi-agency radio communications system (MARCS).’ Added during the 128th General Assembly [2010], section 4501.29 provides for an administration fund directing the Department of Administrative Services to ‘collect user fees from participants in the multi-agency radio communications system (MARCS)’ for that purpose.” The most recent *MARCS Taskforce*

⁶⁶⁶ U.S. Department of Homeland Security, *National Summary of Statewide Communication Interoperability Plans (SCIPs)*.

Report notes: “There presently is no funding source to meet recurring needs to upgrade, extend or expand the system.”⁶⁶⁷ The MARCS Task Force Report also notes that, “The current user fee system, which is based on cost recovery, inhibits broader, more ubiquitous use of the system.”⁶⁶⁸

In Pennsylvania, the required capital investment in PA-STARNet, which became operational in 2003, was made through direct appropriations for that purpose that were augmented from operating funds. The total capital investment, including funds available for 2010, was approximately \$400 million. As of January 2009, coverage was estimated to be 94 percent of the state.⁶⁶⁹ Appropriations for public safety radio services have been financed from both the State General Fund and the Motor License Fund. The long-range plan for financing is to seek appropriations from the State General Fund, or other state funds, along with federal funds when available. The Pennsylvania State Communication Interoperability Plan notes that while federal and state funds will be used for the bulk of capital expenditures necessary to create the system, local units participating in the statewide communication system will be required to finance some capital expenses, maintenance and operational costs. The plan also notes that 911 tax revenues collected on wireless and wireline telephone bills have been used at the local level to support more general public safety communication initiatives.⁶⁷⁰

In Illinois, the state plan indicates that more than \$25 million of State General Fund financing has been utilized to develop and implement the primary statewide voice communication system. An annual appropriation has been available to support ongoing charges for use of the system. Under the terms of the agreement with Motorola, from whom the system is leased, upgrades and maintenance of the infrastructure are the responsibility of the company. State and local agencies that use the radios have the responsibility for paying applicable monthly usage fees.⁶⁷¹

In recent years, New York has received significant federal grant funding to support its interoperable communication system. In 2008, New York State was awarded \$7,835,108 under the [federal] Interoperable Emergency Communications Grant Program (IECGP). Funding was allocated to nine jurisdictions after applications were rated and approved by the State Interoperability Executive Committee. IECGP provides funding to improve interoperable emergency communications capabilities across states, territories, local units of government, and tribal communities and supports the implementation of the Statewide Communication Interoperability Plans. In addition, the State of New York was awarded \$60,734,783 through the Public Safety Interoperable Communications grant program to assist public safety agencies with acquiring, deploying or training for communications systems that enable interoperability with

⁶⁶⁷ Multi-Agency Radio Communications System, *MARCS Task Force Report*, 9.

⁶⁶⁸ *Ibid.*

⁶⁶⁹ Brennan, “Pennsylvania Statewide Radio Network.”

⁶⁷⁰ Commonwealth of Pennsylvania, *Statewide Communications Interoperability Plan*.

⁶⁷¹ State of Illinois, *Statewide Communications Interoperability Plan*.

other radio communications systems operating in the public safety spectrum. Funding was dispersed to New York City in the amount of \$34.8 million and the Strategic Technology Reserve for \$4.7 million. The New York State Interoperability Project received \$6.3 million for statewide planning efforts.⁶⁷²

The effort to maximize use of available federal funds has continued. In 2009, the state CIO/OFT and the New York State Association of Counties submitted an ARRA grant proposal requesting approximately \$265 million to provide dedicated wireless data services to public safety agencies in the northern part of the state.⁶⁷³

The existence of infrastructure used for the public safety network has had other benefits in some locations. Pennsylvania was awarded ARRA funds with which it plans to leverage the microwave public safety communications network to serve anchor institutions in the northern portion of the state. Discussion of this project is follows with information about other ARRA projects.

⁶⁷² New York State, Office of Homeland Security, *Annual Report 2008*, 9.

⁶⁷³ Statewide Wireless Network Advisory Council, *2009 New York State Statewide Wireless Network Annual Report*.

20 Governance and Planning, Centralization and Shared Services

Below we provide a more detailed context for our policy recommendations regarding governance and cost performance monitoring in Volume 1.

State government procurement decisions are often integrated into overarching state strategic planning efforts. In some states those strategic plans helped guide the development of proposals for stimulus funding to expand broadband services. We describe below the state strategies and governance structures that have facilitated progress toward strategic plan development and implementation in New York, Ohio, Illinois, and Pennsylvania. In contrast to those and other states, Florida has not engaged in a comprehensive broadband strategic planning effort, nor has it adopted a state broadband strategic plan that spans all state and local government. We find in our research that Florida’s less centralized approach has enabled innovation and entrepreneurship at the local government level, much like markets organize activities in the private sector.

In the four other states we examined for this report, as in Florida, not all broadband needs of all anchor institutions are being met by a single network. The courts and legislature constitute different branches of government which generally are not required to participate in the Executive Branch networks, but which do in many instances. For reasons discussed below, research and education applications at public research universities and ITS managed by state departments of transportation may be served by dedicated networks that are not part of the state broadband network.

20.1 Governance and Planning

Providing IT services to state agencies, with their varied needs and business processes, is facilitated by a governance structure for IT that is capable of directing resources in the most effective manner. There are a number of working definitions of “governance” in the IT industry.⁶⁷⁴ Most share elements of centralization, planning, collaborative and transparent decision making, and accountability. While both the public and private sectors of the IT industry have been discussing governance models and methodologies for over a decade, a single definition is not uniformly used. NASCIO, in a 2008 publication, focused on IT governance in state government by describing it as being “. . . all about ensuring that state government is effectively using information technology in all lines of business and leveraging capabilities across state government appropriately to not only avoid unnecessary or redundant investments, but to enhance appropriate cross boundary interoperability.”⁶⁷⁵ In the context of interoperability, enabling the sharing of information and other resources, governance also has been defined by the

⁶⁷⁴ See, for example, IT Governance Institute, *IT Governance Roundtable*.

⁶⁷⁵ National Association of State Chief Information Officers, *IT Governance and Business Outcomes*.

Center for Technology in Government as “the existence of appropriate decision making rules and procedures to direct and oversee government interoperability initiatives that are planned or underway . . .”⁶⁷⁶

Among the functions of good governance is a planning process. The IT tools, skills, and infrastructure must be coordinated with the needs of the organization served by that technology. Accomplishing effective coordination requires a plan. “Information technology is always ‘in scope’ in investment planning, change management, innovation, and policy making. Just as finance, communications, human resources, and relationship management are considerations and enablers whenever state agencies are looking at transformation, new business processes, new reach, and new channels for serving citizens, information technology must also be included as a consideration and enabler.”⁶⁷⁷ Just as IT is but one aspect of the business of state government, data networks are but one aspect of IT. Thus, the enterprise plan document (frequently the state IT strategic plan) provides the general framework, direction and vision, but not the specifics of network architecture, technology, and procurement and deployment methods. Those latter elements are addressed by the planning effort of the department charged with network operations responsibility.

20.2 Consolidation and Shared Services

Often central planning becomes a discovery process for economies and efficiencies that may be realized by centralizing certain services and portions of the IT infrastructure. Sometimes, however, centralization is mandated in order to achieve cost savings. All five states we examined have some degree of mandatory centralization of facilities, services, or both. Some aspects of centralization are only possible where a strong and secure data network is functioning. Investment in network infrastructure may be stimulated by the need to centralize certain parts of the larger IT system. Centralizing systems, services and infrastructure in itself requires a significant planning effort because the components of central systems are inherently interdependent.

We found several examples of mandated centralization among the states we examined. Some of those projects can change demands on a network: enterprise e-mail, consolidated data centers, and other enterprise-wide activities. In New York, the state’s enterprise-wide applications “. . . for general ‘back office’ services shared by all agencies include: information technology (IT), financial management, budgeting, procurement, facilities and real estate management, human resources, and employee relations. . .”⁶⁷⁸ Often those efforts to share or consolidate services are driven by the need to save money. For example, the New York Office of State Comptroller

⁶⁷⁶ Pardo and Burke, *IT Governance Capability*, 1.

⁶⁷⁷ National Association of State Chief Information Officers, *IT Governance and Business Outcomes*.

⁶⁷⁸ New York State, *New York State Enterprise Information Technology Strategic Plan 2009-2012*, 24.

recently conducted an audit focusing on consolidation of administrative and support services across agencies. That audit, as a matter of course, looked at some IT functions and suggested cost savings may be realized with greater use of shared services. “Other government entities have adopted this approach for their information technology services and reported significant actual or expected savings, as well as other improvements. We determined that, if New York State adopted a similar shared services approach for its information technology functions, and realized comparable savings, it could save between \$31.5 million and \$221.6 million annually. We recommend consideration be given to adopting such an approach in New York State.”⁶⁷⁹ The report does not indicate whether those anticipated savings are net of any necessary infrastructure enhancement, such as network improvements.

A recent audit in Kansas addressing the potential savings that could be achieved from server consolidation included an observation from an agency that network needs were more complex in the consolidated and virtualized server environment. Another agency noted that before it could focus on server virtualization, it would have to update its networking infrastructure. However, the auditors did not present findings that the state network would be unable to support a statewide data center.⁶⁸⁰

Florida. All the states examined have a central IT planning function except Florida, where aspects of IT planning responsibilities are shared by three entities, AEIT, the TRW, and the Department of Management Services. The CIO Council is used to provide communication among agency CIOs, AEIT, primary data centers and TRW, as well as provide a forum working on best practices development and planning issues. In addition, state agencies are responsible for planning applicable to agency-specific IT projects and activities.

20.3 Agency for Enterprise Information Technology⁶⁸¹

AEIT, established in Florida law⁶⁸² in 2007, is responsible to the highest level of the enterprise, the Governor, the constitutionally created Cabinet, and legislative leaders. The Governor and the Cabinet are designated the head of the Agency. The Executive Director of AEIT is appointed by the Governor, confirmed by the Cabinet, subject to confirmation by the Senate, and serves at the pleasure of the Governor and Cabinet. The statutory scheme provides for a level of accountability by requiring that within the first 60 days of each fiscal year, AEIT report to the

⁶⁷⁹ DiNapoli, *New York State Office of General Services*.

⁶⁸⁰ Kansas Legislative Post Audit Committee, *Performance Audit Report*.

⁶⁸¹ Review of this section was requested January 14, 2011 and timely received from David Taylor of AEIT in time for final publication of this report. We appreciate and acknowledge the review of this section provided by AEIT.

⁶⁸² Sections 282.003-282.34, Florida Statutes. Questions about interpretation or applicability of these or other provisions of Florida law should be directed to competent legal counsel. Statutes cited were accessed from <http://www.leg.state.fl.us/statutes/>. Session laws cited were accessed from <http://laws.flrules.org/>. The Act is codified at sections 282.701 – 282.711, Florida Statutes.

Governor and Cabinet, President of the Senate, and Speaker of the House of Representatives regarding progress toward completion of the prior year’s plan.⁶⁸³

AEIT is charged with developing policies for “the most effective and efficient use of the state’s information technology . . .”⁶⁸⁴ for agencies of the Executive Branch.⁶⁸⁵ AEIT’s duties and authority can be separated into three functions: 1) identifying and developing plans for potential enterprise IT services; 2) executing specified duties for statutorily designated enterprise IT services; and 3) participating in development and implementation of consolidated procurement of IT goods and services. Unlike CIOs in some other states, the Florida CIO does not have formal authority to approve agency budgets or projects. Rather, IT budget and project review and monitoring are the responsibility of the TRW.⁶⁸⁶

The Center for Technology in Government’s description of IT system authority in Florida as “hybrid/federated” is a conclusion based on the statutory language. A separation of responsibilities is created by law whereby state agencies are responsible for “the supervision, design, delivery, and management of agency information technology”⁶⁸⁷ The statute creates a distinction between agency and enterprise IT by defining “agency information technology service” as “a service that directly helps an agency fulfill its statutory or constitutional responsibilities and policy objectives and is usually associated with the agency’s primary or core business functions.”⁶⁸⁸ “Enterprise information technology service” is defined as “an information technology service that is used in all agencies or a subset of agencies and is established in law to be designed, delivered, and managed at the enterprise level.”⁶⁸⁹ The requirement for designation of enterprise services in law ensures that the Governor and Legislature are involved in defining the scope of AEIT’s responsibilities. Services currently designated in statute as enterprise IT services include state data centers, statewide e-mail, and

⁶⁸³ Section 282.0056(5), Florida Statutes.

⁶⁸⁴ Sections 14.204(4) and 282.0055, Florida Statutes. See also Agency for Enterprise Information Technology, *2010 Enterprise Information Technology Services Strategic Plan*.

⁶⁸⁵ “Agency” is defined to mean “any official, officer, commission, board, authority, council, committee, or department of the executive branch of state government” Section 216.011(1)(qq), Florida Statutes. The definition does not encompass the Legislative and Judicial Branches. For purposes of Chapter 282, the definition also excludes university boards of trustees and state universities. Section 282.0041(1), Florida Statutes.

⁶⁸⁶ Created in 1997, the Workgroup’s authority is codified at section 216.0446, Florida Statutes. TRW analyzes and provides to the Legislative Budget Commission recommendations regarding agency funding requests for information technology projects. TRW also conducts oversight of information technology projects identified in the General Appropriations Act. <http://trw.state.fl.us/>, accessed August 20, 2010.

⁶⁸⁷ Section 282.0055, Florida Statutes.

⁶⁸⁸ Section 282.0041(5), Florida Statutes.

⁶⁸⁹ Section 282.0041(13), Florida Statutes.

enterprise IT security.⁶⁹⁰

Certain services lend themselves to centralized procurement and implementation, that is, to being “enterprise” services. By law, AEIT provides input to the designation of enterprise services. The Agency is responsible for making “recommendations to the [Governor and Cabinet] and the Legislature concerning other information technology services that should be designated, delivered, and managed as enterprise information technology services. . . .”⁶⁹¹

While AEIT does not have operational responsibility for enterprise services, Florida statutes are prescriptive regarding the Agency’s role in implementing each of those centralized services. In addition to identifying services for designation as enterprise services, AEIT’s duties related to enterprise IT services, described in Section 14.204, Florida Statutes, include:

- Developing strategies for the design, delivery, and management of those services;
- Monitoring the delivery and management of enterprise services;
- Planning and establishing policies for managing proposed enterprise services;
- Identifying and recommending, in a long-term plan, means and opportunities for improving the delivery of cost-effective and efficient enterprise services;
- Performing specific duties related to the state data center system and the enterprise e-mail service;
- Designating a state Chief Information Security Officer, who reports to the Executive Director of AEIT, and who has responsibility for overseeing the Office of Information Security (duties of the Office are detailed in statute); and
- Developing IT standards for enterprise services.

AEIT’s statutory responsibilities for certain procurement activities emphasize coordination with the Division of Purchasing regarding acquisition planning, negotiation, and consolidation, and include:

- Coordinating with the Division of Purchasing in the Department of Management Services acquisition planning and procurement negotiations for hardware and software products and services in order to improve efficiency and reduce costs of those services;
- Coordinating with the Division of Purchasing in the Department of Management Services procurement negotiations for information technology products that will be used by multiple agencies;
- Establishing best practices for the procurement of information technology products in

⁶⁹⁰ Sections 282.201, 282.318(2), and 282.34, Florida Statutes. See also Agency for Enterprise Information Technology, *2010 Enterprise Information Technology Services Strategic Plan*.

⁶⁹¹ Section 14.204(4)(c), Florida Statutes.

coordination with, and through the services of, the Division of Purchasing in the Department of Management Services, in order to achieve savings for the state; and

- Providing to the Legislature by December 31 each year recommendations of techniques for consolidating the purchase of information technology commodities and services, which result in savings for the state, and for establishing a process to achieve savings through consolidated purchasing.⁶⁹²

In addition to the long-term plan, the Agency is required to develop and publish an annual work plan within the first 60 days of each fiscal year.⁶⁹³ The annual plan must be presented at a public hearing that includes the Agency CIO Council.⁶⁹⁴ The Council is specifically authorized to review and comment on the plan.⁶⁹⁵ Approval of the annual work plan, or any amendment to it, is reserved to the Governor and the Cabinet.⁶⁹⁶ The President of the Senate and Speaker of the House must receive copies of the annual plan.⁶⁹⁷ State agencies are required to provide to AEIT information necessary to complete its annual plan.⁶⁹⁸

Other planning activities assigned by law to AEIT include:

- Planning for managing proposed statutorily authorized enterprise information technology services including development of business cases, establishing and coordinating project management teams, establishing risk assessment and mitigation processes, and providing for independent monitoring of projects for recommended corrective actions;
- Coordinating designated acquisition planning (described earlier);
- Developing an overall consolidation plan for state data centers by December 31, 2010 (This involves consolidation of a number of state data centers into two primary data

⁶⁹² Section 14.204, Florida Statutes.

⁶⁹³ Section 282.0056(1), Florida Statutes.

⁶⁹⁴ Ibid. The CIO Council describes itself “as an educational forum for enterprise information technology planning and management issues, which build consensus using workgroups and committees that develop policies and resolve planning and management deficiencies. ... A primary role of the Council is to improve the coordination and communication among agency CIOs and between CIOs and the Agency for Enterprise Information Technology (AEIT), the Primary Data Centers, the Technology Review Workgroup, and others.” Florida CIO Council <http://www.myflorida.com/cio/>, accessed January 28, 2011.

⁶⁹⁵ Ibid. In addition to that statutorily required collaboration, the 2010 Enterprise Information Technology Services Strategic Plan noted that the plan was developed by AEIT by “leveraging the expertise of the state agencies and of its legislative partners through a series of cooperative planning workgroup sessions. The workgroups committed an enormous amount of time to research and compile input for this deliverable.” Agency for Enterprise Information Technology, *2010 Enterprise Information Technology Services Strategic Plan*, “A Message from Florida’s CIO.”

⁶⁹⁶ Ibid.

⁶⁹⁷ Ibid.

⁶⁹⁸ Section 282.0056(4), Florida Statutes.

centers. Two primary data centers are designated in statute: Northwood Shared Resource Center and Southwood Shared Resource Center)⁶⁹⁹;

- Developing and submitting to the Governor, the President of the Senate and the Speaker of the House a proposed implementation plan for information technology security by December 31, 2010;
 - Through the Office of Information Technology, developing and annually updating by February 1, the enterprise information security strategic plan; and
- Establishing a statewide e-mail project team to develop the implementation plan for the e-mail service and submitting the plan to the Governor, the President of the Senate and the Speaker of the House by July 1, 2011.
- AEIT’s first long-term strategic plan was published October 1, 2010, as required by law. The Agency must biennially update the plan that addresses improvements in the delivery of enterprise information technology services.⁷⁰⁰ AEIT recommended in its *2010 Enterprise Information Technology Service Strategic Plan* that two new enterprise services be designated by July 1, 2011, IT Disaster Recovery and GIS, and that two services be studied for potential designation as enterprise services, local area network services and end-user seat management.⁷⁰¹ Disaster Recovery: “The centralization of IT infrastructure (hardware and software) into three primary data centers in one city, combined with the lack of a comprehensive IT disaster recovery (DR) solution spanning multiple agencies, has increased the risk associated with any disaster. Therefore, Florida needs a standardized IT DR solution for the state. ... AEIT recommends creation of a standardized enterprise IT DR solution.”⁷⁰²
- Geographical Information Service: “Tremendous potential exists for Geographic Information Service (GIS) as an enterprise service to revolutionize the way information can be leveraged to empower state government. By creating a formal, centrally coordinated organizational structure to better manage GIS resources, Florida has the potential to improve information used for the allocation of resources, obtain additional federal funding, save costs at the program level and improve quality of services to the public.”⁷⁰³ As AEIT is a state agency organization, the GIS management suggested would pertain only to GIS systems running on state agency servers.

⁶⁹⁹ Sections 282.201-282-205, Florida Statutes.

⁷⁰⁰ Section 14.204(4)(e), Florida Statutes.

⁷⁰¹ Agency for Enterprise Information Technology, *2010 Enterprise Information Technology Services Strategic Plan*.

⁷⁰² Agency for Enterprise Information Technology, *2010 Enterprise Information Technology Services Strategic Plan*, 4.

⁷⁰³ *Ibid.*, 5.

As mentioned earlier, AEIT is required by law to involve the CIO Council in its planning process.

20.4 Technology Review Workgroup

A key component of IT governance is alignment of expenditures for projects, infrastructure, and related components with enterprise goals and objectives. In Florida, responsibility for budget oversight of governance is assigned to TRW, a Legislative Branch entity. Florida's IT governance structure does not include an executive branch entity that has a similar responsibility regarding state IT budgeting.

TRW was created in 1997 to provide analysis, findings, and recommendations to the Legislative Budget Commission regarding agency funding requests for IT projects. TRW provides direct support to the House and Senate appropriations committees in analysis of funding requests for IT. The TRW also participates with the House and Senate Appropriations analysts and staff from the Governor's Office of Policy and Budget in conducting oversight of high-cost, high-risk, or highly complex IT projects specifically identified in the General Appropriations Act.⁷⁰⁴

In addition to those ongoing responsibilities, the Legislature may assign duties to TRW in statute. For example, Chapter 2009-61, Laws of Florida, required TRW to develop a proposed plan for identifying and recommending options for implementing the provisions of Florida Law, regarding creation of an integrated computer system for the state courts.

20.5 Department of Management Services

Strategic and operational planning for the Florida's enterprise telecommunication network infrastructure is conducted by DMS, as prescribed by law. In addition, specific planning-related responsibilities, beyond those required for operation of the SUNCOM network, were assigned to DMS in 2009. DMS is authorized to implement legislation intended to promote broadband deployment in the state.⁷⁰⁵

One of the tasks assigned to the Department is creation of a strategic plan for increasing the use of broadband Internet service in the state. The statute authorizes the Department to initiate certain actions in order to fulfill its responsibilities.

The Department may collaborate with and receive staffing support and other resources from, Enterprise Florida, Inc., state agencies, local governments, private businesses, and community organizations to:

⁷⁰⁴ Section 216.0446, Florida Statutes and information about TRW responsibilities found at <http://trw.state.fl.us/>, accessed September 10, 2010.

⁷⁰⁵ Section 2, ch. 2009-226, Laws of Florida, codified at Section 364.0135, Florida Statutes.

- Conduct a needs assessment of broadband service in order to develop maps that show areas not served by any broadband provider and areas served by only one provider; the transmission speeds available; and provide a baseline assessment of the portion of households with broadband availability;
- Create local broadband planning groups composed of representatives from a cross-section of the respective community and facilitate the efforts of those planning groups; and
- Encourage the use of broadband service through grant programs facilitating deployment of broadband, especially in rural, unserved, and underserved communities. Priorities for any such grants are described in the statute.

The Department is authorized to apply for and accept federal funds, gifts, and donations for the purposes described in the statute. The Department is authorized adopt rules and regulations, establish committees or workgroups, and enter into contracts necessary or useful to implement the statute. DMS applied for available federal broadband grants and received mapping, planning and supplemental awards to effect some of the statutory directives.

Planning and efforts in the other four states are briefly summarized below:

Illinois: Specific planning for a statewide network is described in *The Next Illinois Century Network: A Vision and Strategic Plan*, published in May 2007.⁷⁰⁶ The report documents a planning effort and resulting recommendations for a variety of decision-makers including the ICN Policy Committee, the Governor, and the Legislature.

The network-specific governance of the Illinois Century Network involves a policy committee created by the Network's 1999 authorizing statute.⁷⁰⁷ Initially established as the governing board for the network, the Illinois Century Network Policy Committee has served since 2003 in an advisory role to the staff of the Department of Central Management Services, which manages the network. The Policy Committee is composed of a maximum of 13 members, six of whom serve *ex officio*: the Directors of the State Library, State Museum, Board of Higher Education, and Central Management Services; the President of the Community College Board; and the Superintendent of the State Board of Education. Up to seven members are appointed by the Governor from private K-12 education, private higher education or other participant groups not represented by *ex officio* members. The Governor's appointees serve three-year, staggered terms. The Chairperson of the Board is appointed by Governor.

The very existence of the Illinois Department of Central Management Services and, specifically,

⁷⁰⁶ Illinois Department of Central Management Services, *Next Illinois Century Network*.

⁷⁰⁷ 20 ILCS 3921/15. <http://www.ilga.gov/legislation/ilcs/ilcs3.asp?ActID=393&ChapterID=5>, accessed September 15, 2010.

the Bureau of Communication and Computer Services, is due to the recognition that certain aspects of state government are more effectively and efficiently executed when centralized. By statute, the Director of Central Management Services, in cooperation with any agency director who is directly responsible to the Governor, may direct the transfer of IT functions from the agency to CMS. The statute provides for the transfer of all assets (including funding streams) and personnel directly related to any transferred functions.⁷⁰⁸ In addition to the broad authority to assume state IT operating responsibilities, the Department implements the IT planning model, known as “IT Governance.” Among CMS’s responsibilities is that it “provide for and control the procurement, retention, installation, and maintenance of telecommunications equipment or services used by state agencies in the interest of efficiency and economy . . .”⁷⁰⁹ Other provisions of Illinois law give CMS broad authority to manage the state telecommunication network, much as DMS is charged with managing the Florida telecommunications network. CMS provides the majority of telecommunication services, including network connectivity, to state agencies as part of a package of managed services. In order “to ensure interoperability, diagnostic capability, and the safeguarding of the network, **client agencies may not purchase, lease or otherwise obtain telecommunications or networking equipment or services with CMS approval.**” [Emphasis in original.]⁷¹⁰

Like Florida, Illinois undertook a move to physically consolidate state agency servers into two primary data centers in 2006. Two years later, server virtualization began. During the virtualization project, 854 old servers were virtualized and 190 new virtual servers added. The Bureau of Communication and Computer Services estimated that the project resulted in a return on investment of more than \$10.8 million between July 2006 and May 2010.⁷¹¹

New York: In New York, a 2002 Executive Order created the position of State CIO, who also serves as Director of the NYS Office for Technology. Pursuant to that Order, the New York CIO has broad authority “. . . to oversee, direct and coordinate the establishment of information technology policies, protocols and standards for state government, including hardware, software, security and business re-engineering, to ensure effective policy planning and implementation to achieve the strategic priorities of the Administration. . . .”⁷¹² The New York State strategic IT plan for 2009-2012 includes several general statements that speak to expectations of the IT networks supporting the state enterprise.

⁷⁰⁸ 20 ILCS 405/405-410. <http://www.ilga.gov/legislation/ilcs/documents/002004050K405-410.htm>, accessed September 15, 2010.

⁷⁰⁹ 20 ILCS 405/405-270(1). <http://www.ilga.gov/legislation/ilcs/ilcs5.asp?ActID=235&ChapterID=5>, accessed September 15, 2010.

⁷¹⁰ State of Illinois, *Customer Service Center: A Telecom Coordinator Guide*.

⁷¹¹ Illinois Department of Central Management Services, *Server Consolidation & Virtualization*

⁷¹² New York State, *New York State Enterprise Information Technology Strategic Plan 2009-2012*.

The state envisions a smart network and accompanying IT infrastructure that facilitates all first responders and supporting staff working together to understand situations or events, to quickly analyze possible responses, to gather required information, and distribute it to the proper authorities to make wise decisions.⁷¹³

Across state government there will be a shared function that will audit networks, and, among other things, ensure public information and the systems used to create and access information are secure.⁷¹⁴

For planning and implementation purposes New York has adopted an approach of tying IT procurement to agency clusters--economic development and infrastructure, education, energy and environment, financial regulations, government operations and oversight, labor, health and human services, and public safety and security – organized around three tiers. Tier 1 refers to statewide enterprise IT shared services and infrastructure, operated on the premise of cost-efficiency and is centrally managed by CIO/OFT. Tier 2 refers to mission-critical applications which encompass applications that may be shared by more than one agency and for which the lead agency assumes responsibility for procurement, operation, maintenance, and replacement on behalf of it and other agencies sharing the application. Tier 3 refers to special purpose applications for which a single agency has total responsibility for application procurement, operation, maintenance, and replacement.⁷¹⁵

Ohio: Ohio has a strategic plan for a statewide network. Implementation of that plan was interrupted by budget shortfalls and eclipsed by the advent of ARRA funding for the Ohio Middle Mile Consortium and the Connect Ohio mapping initiative.⁷¹⁶ Ohio's Statewide IT Strategic Plan articulates broad goals and objectives that may be accomplished with an effective broadband network. Among those goals are the following:

- Building cooperation across governments to share infrastructure, applications and data to improve delivery and make government more transparent and understandable
- Making possible the secure connectivity and the efficient flow of information among all levels of government
- Extending the portfolio of on-line services and transactions, and make it easier for existing and new businesses to complete their interactions with government quickly and effectively

⁷¹³ Ibid., 38.

⁷¹⁴ Ibid., 39.

⁷¹⁵ New York State, *New York State Strategic I.T. Clusters Charter* and New York State, *Service Level Agreement for Enterprise IT Shared Services*, 10-11.

⁷¹⁶ Lynne Holt conversation with Katrina Flory, Office of Information Technology, August 16, 2010.

- Coordinating the sharing of tools, solutions, and processes to maximize the state’s investment⁷¹⁷

In 2004 the Governor of Ohio issued an Executive Order,⁷¹⁸ subsequently codified in law,⁷¹⁹ creating the office of CIO, the Office of Information Technology, the Information Technology Investment Advisory Council, and the multi-agency CIO Advisory Council. The CIO, under current law, is appointed by the Director of Administrative Services and has broad authority “under the direction of the director of administrative services. . . [to] oversee, and direct state agency activities related to information technology development and use. . . .”⁷²⁰ The Ohio CIO is the director of the Office of Information Technology. While certain state entities are not subject to the authority of the CIO, exempt entities that purchase services via state contracts administered by the OIT may become subject to CIO policies by virtue of the service acquisition.⁷²¹

The Statewide IT Strategic plan opens with an acknowledgement of the importance of collaboration: “Ohio’s Office of Information Technology (OIT), in cooperation with Ohio’s agencies, has developed this Statewide Information Technology (IT) Strategic Plan to provide a framework for the state’s agencies as they work together and with OIT to implement statewide and agency technology initiatives. While Executive Order 2004-02T designated OIT with responsibility for the development of this strategic plan, all agencies are responsible for its implementation. State agencies have actively participated in developing the plan through the committees of the Multi-Agency CIO Advisory Council (MAC).”⁷²²

Pennsylvania. Pennsylvania’s report, *Overview of Strategic Focus: 2009-2011*, published by the Governor’s Office of Administration, Office for Information Technology, updates the Commonwealth’s “Keystone Plan (2006-2009).” To the extent that both documents lay out a high level plan for the conduct of state business utilizing IT tools, neither plan document focuses on the detail of data networks specifically.

Pennsylvania’s planning effort has a strong centralization component. The initial centralization effort was begun by Governor Ridge in 1995. The Commonwealth continued its move to more centralized IT management with the issuance of an Executive Order by Governor Rendell in 2004. The initial effort resulted in, among other things, development of a shared e-mail

⁷¹⁷ Ohio.gov., “Ohio’s Information Technology: Statewide IT Strategic Plan.”

⁷¹⁸ State of Ohio, *Specifying Revised Responsibilities for State Information Technology Governance*.

⁷¹⁹ ORC 125.18. <http://codes.ohio.gov/orc/125>, accessed September 16, 2010 .

⁷²⁰ Ibid.

⁷²¹ State of Ohio, *State of Ohio IT Policy*.

⁷²² Ohio.gov., “Ohio’s Information Technology: Statewide IT Strategic Plan.”

application and network for state agencies.⁷²³ The 2004 Executive Order relied upon the Administrative Code of 1929 to underpin the goal that “investments and development efforts should be prioritized across the Commonwealth and coordinated across agencies to enhance information sharing, standardization, and cost-effectiveness.”⁷²⁴ The Executive Order created the Enterprise Information Technology Governance Board to “establish an Enterprise IT Governance Structure to oversee the investment and performance of information solutions across the Commonwealth’s agencies and to advise and counsel the Governor on the development, operation, and management of the Commonwealth’s IT investments, resources, and systems.”⁷²⁵ The Board is composed of the secretaries of Administration, Budget, and General Services; the Governor’s Chief of Staff; the Deputy Secretary for Information Technology/Office of Administration, who serves as the Commonwealth’s CIO; and other members appointed by the Governor. Some of the work undertaken pursuant to the Executive Order has resulted in consolidation of elements of the commonwealth’s IT services and infrastructure. According to the Pennsylvania Governor’s budget document for FY 2011, most agencies that complete the consolidation assessment process choose to turn IT functions over to the Office of Information Technology. Some agencies, however, merge with peer agencies instead. “For instance, the Board of Probation and Parole folded its IT operation into that of the Department of Corrections.”⁷²⁶ In Florida, the Parole Commission met a requirement to consolidate its IT operations with those of DOC by July 1, 2009.⁷²⁷

The Pennsylvania Governor’s Office of Administration/Office for Information Technology has significant responsibility for, among other duties, establishing and implementing a statewide IT strategic plan, procurement and contract management, program management and business process integration, consolidating agency IT services, and “establishing a process for the development and implementation of Commonwealth telecommunications strategy policy, services, and infrastructure, and reviewing and authorizing requests for enhanced services. In regard to telecommunications, the Office of Information Technology is directed to coordinate the Commonwealth’s telecommunication policy and technical infrastructure regarding Commonwealth’s education, economic development, residential, and commercial communities.”⁷²⁸

With direction provided by the 2004 Executive Order, the Pennsylvania Office of Information Technology undertook a “telecommunication modernization” effort in 2009 to consolidate work

⁷²³ National Association of State Chief Information Officers, “Awards and Recognition, 2001 Awards: Information Architecture.”

⁷²⁴ Commonwealth of Pennsylvania, *Enterprise Information Technology Governance Board*.

⁷²⁵ *Ibid.*

⁷²⁶ Commonwealth of Pennsylvania, *Governor’s Executive Budget 2010-2011*, 89.

⁷²⁷ Agency for Enterprise Information Technology, “Data Center Consolidation.”

⁷²⁸ Commonwealth of Pennsylvania, *Governor’s Executive Budget 2010-2011*, 89.

performed under 17 telecommunications contracts into a single contract. During the effort, Verizon was selected to provide managed services, including all voice and data networks, Internet and security services, managed network services, and managed voice services.⁷²⁹ One notable aspect of the planning process for this consolidated procurement was the support team assembled for the RFP process. An objective of the effort was to expand involvement of agencies, *i.e.*, engage in enterprise-wide collaboration of stakeholders and subject matter experts. In addition to participants from the Office of Information Technology, the team included staff of the Pennsylvania State Police, the Departments of Health, General Services⁷³⁰, Public Works, Labor and Industry, and Transportation; and the Bureau of Minority and Women Business Opportunities. Fifty other “extended team members” supported the core team in the development and review of requirements for the consolidated managed services contract. The Verizon contract was awarded in October 2009 and the transition is scheduled to be complete by February 2011 when the prior contract expires.

⁷²⁹ Commonwealth of Pennsylvania, “Telecommunications Managed Services Update.”

⁷³⁰ The Pennsylvania Department of General Services oversees procurement of goods and services, and manages non-highway capital projects, the vehicle fleet, the Capitol Police force, and state buildings and facilities. DGS also serves as the state’s real estate agent and insurance broker.

21 American Recovery and Reinvestment Act (ARRA)

Below we provide a more detailed context for our financial modeling and our policy recommendations regarding governance and centralization in Volume 1.

Effective use of resources, such as BTOP grants, propels middle-mile infrastructure deployment and furthers connectivity among governmental entities at all levels. Once the networks are expanded, new opportunities for collaboration and information sharing will undoubtedly result bringing with them the demand for new applications and services and new opportunities for collaborative improvement of broadband services if states are positioned to take advantage of the opportunities. Five tables included in Section 18 display the BTOP grants that have been awarded to the five states. While the focus of this study is network infrastructure and services, state and local government and anchor institutions access to and use of broadband services may benefit from the other categories of ARRA grants.

Even prior to the availability of the ARRA funding, two of the five states we reviewed (Illinois and Ohio) had developed strategic plans for their respective state network infrastructure. Arguably, those two states were better positioned to take advantage of the stimulus funds. Illinois developed a plan to invest in a statewide, state owned fiber network backbone for ICN to replace the leased line circuits.⁷³¹ Ohio developed a migration plan for an aggregated end-to-end network. The project has encountered funding constraints, so it is not progressing as originally scheduled. New York developed its strategic plan in June 2009 after the ARRA money was authorized.⁷³² Pennsylvania's very high level strategic plan does not speak to a statewide network, *per se*, because the Commonwealth primarily purchases services from a vendor. Florida is utilizing federal planning funds to develop its plan for providing broadband service to state and local governments and anchor institutions.

The paragraphs that follow briefly describe BTOP infrastructure projects in the five states we examined.

Florida. Florida entities received a total of \$55.9 million of BTOP funds for three infrastructure projects completely within the state.

- The North Florida Broadband Authority received \$30.1 million for a middle mile project to provide high-speed broadband services to underserved areas in 14 North Central Florida counties. The project will involve deployment of a 1,200 mile fixed wireless broadband network. The project was jointly created by the area's local governments and is planned to serve more than 300 community anchor institutions.

⁷³¹ State of Illinois, *Illinois Century Network Fiber Migration*.

⁷³² New York State, *Connecting New York to the World*.

- The FRBA received \$23.7 million to deploy 1,800 miles of microwave-based middle-mile network infrastructure in three designated Rural Areas of Critical Economic Concern. A goal of the project is to create a collaborative effort of local and tribal governments, economic development agencies and commercial partners to address the broadband needs of the area.
- Level 3 EON, LLC, was awarded \$2.1 million to build seven new access points on Level 3's existing broadband network to enable access for last mile providers.

Illinois. Illinois entities have received \$142.4 million of BTOP infrastructure grants for four projects wholly within the state. ICN improvements planned for use of ARRA funds will be based on installation of a state-owned fiber network. A recent BCCS newsletter states: "This fiber infrastructure levels the playing field for all networks and service providers by providing economical access to critical broadband facilities located in Illinois. We will offer services at multiple layers of the network including: dark fiber, Lambdas or light waves, Ethernet ports, and Internet egress."⁷³³ These projects are consistent with recently developed migration plans for ICN.

- Approximately \$22.5 million was awarded to the University of Illinois to partially fund its Urbana-Champaign Big Broadband project. This project will involve construction of 187 miles of fiber network that will serve anchor institutions and fiber-to-the-home on a pilot project basis for low-income households.
- The DeKalb County Government received a grant of nearly \$11.9 million for a project that is sponsored by the County, Northern Illinois University and DeKalb Fiber Optic. The project will install 130 miles of fiber optic infrastructure in DeKalb and LaSalle counties. Five networks will utilize the fiber infrastructure. Each of those networks will serve a specific community.
- The State Department of Central Management Services was awarded nearly \$62 million to develop a high-speed middle mile network in northeastern, central, and eastern portions of the state. The project will involve building over 1,000 miles of new fiber infrastructure and upgrading approximately 1,000 miles of the ICN. This project will interconnect with the DeKalb county project and the University of Illinois project.⁷³⁴
- Northern Illinois University received a BTOP grant of approximately \$46.1 million to deploy an 870-mile network in nine counties in the northwest part of the state.

Collaboration is part of these efforts in that the migration plan includes working with a variety of

⁷³³ Illinois Bureau of Communication and Computer Services, *Pulse Newsletter*.

⁷³⁴ National Telecommunications and Information Administration, "Illinois."

public entities to connect publicly owned fiber, where it is available, to the CMS installed fiber.⁷³⁵ For example, as described in the ARRA project summary for the East Central portion of the Illinois Broadband Opportunity Partnership project, “the Illinois Department of Transportation and the Illinois State Toll Highway Authority are providing access to existing fiber. The Illinois Century Network has existing network facilities, many located on university campuses, throughout the state that can be used for the optical equipment and network access points.”⁷³⁶ Other existing public and public/private networks that will be leveraged are cited in the summary of the project segment for the northwestern region of the state, “. . . Northern Illinois University Regional Network (NIUNet) (Public Only); Northern Illinois Technology Triangle (NITT) (Public/Private); Illinois Municipal Broadband Communications Association (IMBCA) (Public/Private); TriRivers Heath Organization network (TriLightNet) (Public/Private); Northwest Municipal Broadband Authority (NMBA) (Public Only); Illinois Century Network (ICN) (Public Only); [and] Illinois Rural HealthNet (IRHN) (Public/Private Medical) . . .”⁷³⁷

Ohio. Beginning in spring 2009, local governments planned to start migrating to the OARnet backbone and join state agencies that were already part of the Broadband Ohio Network. The original plan was to migrate all government entities, including local government, courts, education and economic development facilities incrementally in Ohio’s 88 counties to Broadband Ohio Network, but that didn’t happen. The network only received \$8.6 million in FY 2008 before the downturn hit and the migration was halted.⁷³⁸ Only several pilot projects showcasing local governments were undertaken before the migration was halted.⁷³⁹

As of mid-September, three organizations in Ohio had been awarded a total of \$141.3 million BTOP grant funds for broadband infrastructure projects to be deployed exclusively in Ohio (some BTOP grant recipients propose to serve multiple states). In total, the projects will add more than 3,500 miles of optical fiber, which, among other purposes, should benefit local governments and other anchor institutions.⁷⁴⁰

- ComNet, Inc. proposes using \$30 million of ARRA funding to expand OARnet to include

⁷³⁵ State of Illinois, *Illinois Century Network Fiber Migration*.

⁷³⁶ National Telecommunications and Information Administration, “Illinois Broadband Opportunity Partnership East Central Region.”

⁷³⁷ National Telecommunications and Information Administration, “Illinois Broadband Opportunity Partnership Northwest Region.” The same existing networks are cited in National Telecommunications and Information Administration, “DeKalb Advancement of Technology Authority Broadband.”

⁷³⁸ 127th General Assembly, Amended House Bill Number 381 **Sec. 263.20.90**, Third Frontier Research & Development Projects and Research & Development Taxable Bond Projects
http://www.legislature.state.oh.us/bills.cfm?ID=127_HB_381.

⁷³⁹ Ohio Broadband Council, *Ohio Broadband Council Minutes*.

⁷⁴⁰ National Telecommunications and Information Administration, “Ohio.”

additional anchor institutions.

- OneCommunity’s Transforming NE Ohio project is expected to build 900 new miles of fiber, connecting to 2,000 miles of existing network.
- The Connecting Appalachian Ohio Middle Mile Consortium received a grant to construct 1,960 new miles of fiber and will interconnect with the OneCommunity and ComNet projects.

These projects involve collaboration and also appear to conform to the Broadband Ohio Network’s vision because they will use OARnet as a backbone and will expand the statewide fiber-optic network.⁷⁴¹

In contrast to Illinois and Ohio, New York, Pennsylvania, and Florida did not have statewide strategic plans in place prior to the availability of federal funding. Interestingly, there appears to have been less BTOP infrastructure moneys awarded in those states.

New York. New York entities that received BTOP infrastructure funds all proposed to serve more than one state.⁷⁴²

- New York’s ION Hold Company, LLC, a for-profit company based in Albany, received \$39.7 million in BTOP infrastructure funds to develop a regional broadband network of more than 1,300 miles to connect more than 100 community institutions, including libraries, state and community colleges and health clinics. Parts of Pennsylvania and Vermont will also be served by this grant award.
- Vermont Telephone Company received \$12.3 million for a multi-state project to address a bandwidth and transport capacity shortage in the state’s existing middle mile infrastructure in one community in New York State and in Connecticut and Vermont.

Pennsylvania. Pennsylvania entities received a total of \$128.4 million of BTOP infrastructure funds for two projects that serve exclusively Pennsylvania.⁷⁴³

- KINBER, a non-profit organization, was awarded more than \$99.6 million to develop a 1,700-mile fiber network (PennREN) in south and central Pennsylvania. The network will serve as the state’s first multi-institution higher education network, as well as K-12

⁷⁴¹ Ohio Broadband Council, “FAQs of Broadband Ohio,” <http://www.ohiobroadbandcouncil.org/faqs/index.shtml#1>. [“Additionally, Broadband Ohio will provide 'middle mile' connections to each of Ohio's 88 counties, making it less expensive for private telecom companies to provide the 'last mile' connection to individuals and businesses.”]

⁷⁴² National Telecommunications and Information Administration, “New York.”

⁷⁴³ National Telecommunications and Information Administration, “Pennsylvania.”

schools, healthcare facilities and research organizations.

- A BTOP grant of \$28.8 million also was awarded to the state to help fund a “middle mile” project in northern Pennsylvania. The project will build on publicly owned assets (the existing public safety network) that are part of the statewide public safety radio network.

22 Participants: Service Provider Forum

November 18, 2010

Betty Easley Center, Tallahassee

Stan Greer, AT&T

Bill Thomas, Northeast Florida Telephone Company

Phil Winter, Sprint

Bob Demmery, Sprint

Alan Phelps, TelCom Manager for Ocala Utility Services

Jim Tait, Ecosystem Partners

Chuck Waters, Windstream Communications

Don Landin, FPUAnet Communications Division of Ft. Pierce Utilities Authority

Chuck Spalding, Palm Beach Broadband

Danny Thomas, AT&T

Bruce Renard, Connected Community Infrastructures, LLC (CCI)

Jahan Babedi, Connected Community Infrastructures, LLC (CCI)

Frank Peake, Connected Community Infrastructures, LLC (CCI)

Frank Holcomb, TDS

Al Samball, NFBA

Marguerite McCauley, NFBA

Diane Scholz, Institute of Government

Bob Collie, Education Networks of America

Bridget Duff, Broadband Education Consultants

Demetria Clark, Verizon

23 Appendix I: Summary of the 2009 DMS Local Broadband Inventory Survey and 2010 Magellan Advisors Local Broadband Inventory Survey

In order to maintain continuity, the 2010 Magellan Advisors Local Broadband Inventory Survey asked the same questions as the 2009 survey conducted by the Department of Management Services. In addition, the 2010 survey included the following additional questions:

- Does your community face obstacles due to the lack of readily available broadband infrastructure in your area? If yes, please provide detailed explanations of those issues.
- What types of important local initiatives could be enabled by a more robust broadband infrastructure in your region? (technology collaboration, video, data sharing, emergency response, etc.)
- Does your community face local or state policy issues that prevent you from meeting your broadband needs? If yes, please explain specific issues.
- What would your jurisdiction like to see from a state/regional broadband planning effort? Please be as specific as possible.
- Do you own or lease a wired or wireless county or city Metropolitan Area Network (MAN) or plan to? If yes, please describe the design, the size and customer base.
- Do you connect directly to a Tier 1 carrier class provider (AT&T, Verizon, Qwest, Level 3, etc.)? Please describe type (directly or indirectly), speed, and number location? If not, do you plan to?
- Do you own or lease any type of fiber network or plan to. If so, do you have any available or planned fiber cabling routes that have spare capacity. If yes, please describe (route miles, strand counts, excess capacity, etc.)
- Please list any secured shelters with electrical power and A/C capable of housing broadband network equipment. Provide a detailed listing with locations (street address, location coordinates, network diagram, etc.) if possible.
- Please describe any rights of way or spare conduits, owned by your city or county, where a fiber network could be installed, by mile markers or a City or County map showing the route of the right of way.
- Do you have any access to any radio towers, owned or managed by your city or county that may have available space for the installation of wireless broadband equipment. If yes, please indicate location and height of possible free space (provide location coordinates or FCC tower registration number(s))
- Do you plan to or have access to utility poles where an aerial fiber network or wireless access points could be installed?
- Are there any additional comments that perhaps were not covered within the context of

the survey questions that you would like to provide?

Both the 2009 and 2010 survey responses are summarized in this Appendix.

Cities

Sixty-nine cities responded to the 2009 survey, and 16 additional cities responded to the 2010 survey. In addition, 16 cities who responded in 2009 also responded in 2010. Table 23-1 lists the respondents.

Cities which Own/Lease Metropolitan Area Network:

- Bartow: “The City of Bartow owns a wire fiber optic MAN. The MAN consists of several miles of 48, 96, & 144 count single mode cables. The main design is a ring topology with several lateral connections and sub-rings. The ring is used to serve internal communications; provide point-to-point & network connections for other government connections; provide internet connectivity for a small number of private customers. The City of Bartow’s network interconnects with the City of Lakeland’s network” (2009 Local Broadband Inventory Survey).
- Coral Gables: “The City has a contract agreement with Comcast. It is called an I-NET Fiber Network. Comcast terminated two (2) strands of dark fibers in city buildings, parks and remote facilities, public and private K-12 schools, and the University of Miami. Currently, four (4) major city buildings and several remote locations along with one (1) private school are interconnected with electronics (i.e., Layer 3 switches) at a speed of 1 Giga bits per second. The access speed for each of these activated locations is 10/100 Megabits per second. The logical/physical design of this network is a folded fiber rink configuration. One of the City sites has a backup wireless point-to-point (PTP) link. The City plans to install additional wireless PTP links to provide backup connection for other major locations to eventually replace the current leased 10 Megabits per second Metro-Ethernet services from the local carrier. The City is also part of the Miami Dade Broadband Coalition. We are in the process of developing a partnership with the County, other cities, state agencies, schools, universities, hospitals, and other non-profit and for-profit organizations such as the Knight Foundation, Florida Lambda Rail (FLR), and FPL” (2009 Local Broadband Inventory Survey).

Table 23-1. Cities Responding to 2009 and 2010 Surveys

2009		2010
Atlantic Beach	Lakeland	Bunnell
Avon Park	Leesburg	Cape Coral
Babson Park	Lighthouse	Cocoa
Bartow	Live Oak	Daytona Beach
Bascom	Longwood	Deltona
Bell	Lynn Haven	Edgewater
Bristol	Margate	Fernandina Beach
Bronson	Milton	Fort Myers
Bunnell	Monticello	Ft. Lauderdale
Chipley	Mt Dora	Haines City
Cocoa	North Palm Beach	Holly Hill
Coral Gables	Oak Hill	Jacob
Crescent City	Ocean Ridge	Jasper
Cutler Bay	Ormond Beach	Jupiter
Daytona Beach		Key Colony Beach
Edgewater	Oviedo	Largo
Flagler Beach	Palm Bay	Leesburg
Fort Myers	Palm Coast	Lynn Haven
Gainesville	Plantation	Melbourne
Greenwood	Pompano Beach	North Lauderdale
Gulf Stream	Punta Gorda	North Port
Haines City	Raiford	Ocala
Highlands	Rockledge	Ocoee
Hollywood	San Antonio	Ormond Beach
Indian Harbour	Sarasota	Palm Coast
Islamadora	South Daytona	Sarasota
Jacob	St. Augustine	St. Augustine Beach
Jasper	St. Leo	The Villages
Jupiter	Tampa	West Melbourne
Key Colony Beach	Temple Terrace City	Wilton Manors
Key West	Treasure Island	Winter Garden
Kissimmee	Vero Beach	Winter Park
Lady Lake	Village NPG	
Lake Butler	West Miami	
Lake City	Zephyr Hills	

- Daytona Beach: “The City of Daytona Beach owns and operates an outside plant network comprised of fiber optic cabling that services most of the City’s buildings and

signalized traffic intersections. The size of the cable plant is approximately 70 miles and is comprised of varying types of fiber optic cables installed both aerially as well as buried. The system involves three interconnected rings servicing the beachside, downtown mainland area, and western city. The customers of the system are city facilities. The City leases a pair of fibers from Level3 and has equipment collocated at Level3's Holly Hill Fl., facility. This link is used to purchase WAN connectivity for the eight City sites that are not accessible by the city's own fiber, and to purchase other services, such as dedicated long distance. The link between the city's data backbone system and the Level3 facility is advertised at 1 gigabit using City owned data switching equipment at both ends of the link" (2009 Local Broadband Inventory Survey).

- Fort Myers: "Yes, we have a combination of leased T1 and Fiber connecting the City's buildings for our internal network. We have 32 locations connected to our network" (2009 Local Broadband Inventory Survey).
- Gainesville: "We do own some of our own fiber. It is a home-run from our data center to other target sites. No redundancy exists" (2009 Local Broadband Inventory Survey).
- Haines City: "The City of Haines City owns a private fiber MAN for City business. Ten remote departments are connected to City Hall (the hub for communications)" (2009 Local Broadband Inventory Survey).
- Highlands: "We currently have a number of T1 and fiber connections making up a MAN" (2009 Local Broadband Inventory Survey).
- Hollywood: "a) Managed 10gbNetwork (Comcast) connecting 32 City facilities for City use only; b) Managed Wireless Network (Johnson Controls) using Motorola equipment with a 20mb wireless internet connection (Sling Broadband)" (2009 Local Broadband Inventory Survey).
- Islamorada: "Islamorada leases a MAN utilizing a State Contract through MyFloridaNet with a synchronous 3 MB Bonded T1 internet connection between our Administrative Center and our Fire Rescue EOC. Our customer base is approximately 60 users" (2009 Local Broadband Inventory Survey).
- Jupiter: "Leased wired (fiber and copper)" (2009 Local Broadband Inventory Survey).
- Kissimmee: "The Kissimmee Utility Authority has partnered with the City of Kissimmee and the Toho Water Authority to build a joint usage wireless network that serves municipal data needs and provides free and premium WiFi access to residents. This is a pilot project covering 2 square miles" (2009 Local Broadband Inventory Survey).
- Lakeland: "The City of Lakeland owns its Metropolitan Area Network. It is comprised of approximately 280 miles of fiber with 14 gigabit Ethernet switches. These switches make up the core City of Lakeland network. We also have three (3) OC12 SONET rings and also one (1) OC3 SONET ring to transport traditional TDMA circuits. The SONET rings are used mostly for substation control information for the City owned electric

utility. The Ethernet network is primarily in place to serve the needs (both IP and VoIP) of our 2600 city employees. The City of Bartow’s network interconnects with the City of Lakeland’s network” (2009 Local Broadband Inventory Survey).

- Ocala: “We presently have 300 + miles of fiber in our city. We lease to others, mostly 96 fiber builds” (2010 Local Broadband Inventory Survey).
- Palm Coast: “Our network is 95% on city owned single mode fiber optics. We have a few leased lines from ATT and Bright House Networks. Our network serves approx. 20 city sites. There are plans to connect the city’s fiber network into the County and School Board facilities as well” (2009 Local Broadband Inventory Survey).
- Tampa: “8 Point to point Wireless Bridge circuits between city facilities” (2009 Local Broadband Inventory Survey).
- Vero Beach: “We own a wired MAN that connects nine city buildings over the City’s fiber optic cable. It is used as the backbone for City voice and data networks. The City is the only customer that we support and there are approximately 500 phones and 350 data devices attached to the MAN. Vero Beach network is jointly operated with Indian River County” (2009 Local Broadband Inventory Survey).

Cities which are considering a Metropolitan Area Network include:

- Cocoa: “It is in city 5 year plan” (2009 Local Broadband Inventory Survey).
- Jupiter: “Investigating owning/operating fiber network” (2010 Local Broadband Inventory Survey).
- Leesburg: “We are currently discussing a Metropolitan Area Network and how it would integrate with our existing fiber network” (2009 Local Broadband Inventory Survey).
- Palm Bay: “Several businesses are investigating a partnership with the city” (2009 Local Broadband Inventory Survey).
- Sarasota: “The City is considering replacing copper ATMS lines with fiber, which it would then own” (2010 Local Broadband Inventory Survey).

The cities that indicated in the 2009 Survey that they do not operate a Metropolitan Area Network and have no plans to do so include: Atlantic Beach; Avon Park; Babson Park; Bascom; Bell; Bristol; Bronson; Bunnell; Chipley; Crescent City; Cutler Bay; Edgewater; Flagler Beach; Greenwood; Gulf Stream; Indian Harbor; Jacob; Jasper; Key Colony Beach; Key West; Lady Lake; Lake Butler; Lake City; Lighthouse; Live Oak (“N/A”); Longwood; Lynn Haven; Margate; Milton; Mount Dora; Oak Hill; Ocean Ridge; Ormond; Oviedo (“N/A”); North Palm Beach; Plantation; Pompano Beach; Punta Gorda; Raiford; Rockledge; San Antonio; Saint Augustine; St. Leo; South Daytona; Temple Terrace City; Treasure Island; Village NPG; West

Miami; and Zephyr Hills. Monticello operated a wireless network for public and governmental use but discontinued the service in 2007 (2009 Local Broadband Inventory Survey).

It should be noted that some cities which had no plans for Metropolitan Area Networking in the 2009 Survey later became participants in the regional wireless networking initiatives in the three Rural Areas of Critical Economic Concern (RACEC) areas (NFBA and FRBA).

According to the 2009 Survey, some cities operate fiber optic facilities for communications between buildings, agencies and other locations: Atlantic Beach; Cocoa; Indian Harbor; Key West; Leesburg; Lighthouse; Longwood; Margate; Milton; Mount Dora; Ormond; Oviedo; Palm Bay; Punta Gorda; Rockledge (planned); St. Augustine; and Tampa. Additional cities noted in the 2010 Survey which operate fiber optic facilities include City of Fernandina Beach; City of Largo; City of Ocoee; City of Ormond Beach; City of Wilton Manors; City of Winter Garden; and City of West Melbourne.

Counties

Nineteen counties responded to the 2009 survey, and 5 additional counties responded to the 2010 survey. In addition, two counties who responded in 2009 also responded in 2010. Table 23-2 lists the respondents.

Table 23-2. Counties Responding to 2009 and 2010 Surveys

2009	2010
Alachua	Alachua
Baker	Baker
Broward	Charlotte
Clay	Flagler
DeSoto	Lake
Gadsden	Martin
Gilchrist	Volusia
Glades	
Hillsborough	
Indian River	
Lee	
Marion	
Miami Dade	
Osceola	
Pasco	
Pinellas	
Polk	
St. Johns	
Walton	

Own/Lease Metropolitan Area Network:

- Alachua County: “Leases a wired MAN. It is a hub and spoke design with our data center at the hub. It encompasses 45 schools and centers” (2009 Local Broadband Inventory Survey).
- Baker County: “Owns buried fiber, and leases dark fiber from the local telecom, this connects most county offices with the courthouse being the central hub, it spans across several blocks inside of the city of Macclenny, Florida, the leased lines connect county annexes and EOC, the owned line connects the jail and courthouse, there are plans to extend the buried line to include a new Commission Office in the near future. The data rates range from 1.5Mbps all the way to 1Gbps” (2009 Local Broadband Inventory Survey).
- Broward County: “We own our own fiber optic network serving 18 locations. We also lease an OC12 ring from AT&T serving another 70 locations. The networks support over 5,000 users” (2009 Local Broadband Inventory Survey).
- Desoto: “Desoto Life Wireless internet service. At the present we have 114 customers” (2009 Local Broadband Inventory Survey).
- Hillsborough County:
 - “County Administrator/BOCC - ITS is currently in the process of deploying a fiber based Metro Ethernet solution that is provided by BrightHouse. There will have two primary sites (main facility - County Center and Disaster Recovery/Business Continuity location - Sabal Park) that will be the termination points of the various vlans from the remote sites that will utilize this solution. At present, orders for service have been placed to install at our EOC site and the Lake Magdalene Children’s Services site, in addition to the two primary sites. There are several other remote sites with bandwidth concerns that we are considering for this solution (2009 Local Broadband Inventory Survey).
 - Clerk of Circuit Court – IT department has a free-space optics (laser) backbone located in downtown Tampa. It provides failover connectivity for the Clerk of Circuit Court networks, located in seven buildings downtown, and supports more than 600 employees. The ring is capable of full-duplex operation at 1 Gbps throughput, maximum. However, periods of service disruption may occur at various times, on any leg of the ring, due to the position of the sun and its reflected light. This ring connects to existing network equipment which is served by fiber-optic cabling, and comprises rooftop equipment located at the following buildings” (2009

- Local Broadband Inventory Survey).
- Sheriff's Office - We currently own our own fiber ring, and utilize some county fiber infrastructure. We are leasing bandwidth from several vendors to connect facilities that are outside our ring.” (2009 Local Broadband Inventory Survey).
 - Indian River County: “Jointly owned fiber optic cable based WAN. Vero Beach network is jointly operated with Indian River County” (2009 Local Broadband Inventory Survey).
 - Lake County: “We have a campus area fiber network - it is 96 count single mode but is only a few city blocks square” (2010 Local Broadband Inventory Survey).
 - Marion: “Marion County leases from: “Cox - 1 10Mb connection, AT & T - 3-point-to-point T1s, AT & T/Embarq - a meet-point T1 to Dunnellon, Embarq - 1 point-to-point T1, Embarq MAN - 41 T1s, 4-10Mb connections, 2-100Mb connections, Windstream – 2-point-to-point T1s.” Marion County leases dark fiber to connect various locations (2009 Local Broadband Inventory Survey).
 - Miami Dade: “The County does have small segments of a fiber optic network that it directly owns; however through a contractual agreement, it has beneficial use of over 100 miles of fiber optic dark fiber. The County has installed electronics and has energized these strands via a dense wave network” (2009 Local Broadband Inventory Survey).
 - Pasco: “Pasco County is currently migrating its remote wired frame relay sites to cable modem, DSL FiOS with VPN tunnels to ISP connection in Dade City. Pasco County serves two remote locations wireless which are across the road from the NPR Campus.” “Currently, Pasco County leases two (2) 100M WAN fiber networks which are totally redundant with diverse paths to two (2) County buildings on the east side (Dade City) and west side (NPR Campus). These redundant paths are connected via County owned fiber in Dade City and NPR campus. One WAN is utilized by County Departments and three (3) Elected Official Offices. The second WAN is utilized by the Clerk's & Comptroller's Office, Sheriff Office and Courts including Judicial, Public Defender and State Attorney Offices. The County WAN also has two (2) 100M spokes to Land O'Lakes and Trouble Creek facilities and four (4) 10M spokes to Fleet, Public Transportation, and two (2) Tax Collector satellite offices in New Port Richey and Zephyrhills. The Courts WAN has two spokes: one to the LOL Detention Center and the second spoke to Pinellas County (6th District Courts)” (2009 Local Broadband Inventory Survey).
 - Pinellas County: “The County technology department (Business Technology Services) owns several miles of dark fiber connecting various sites and building

within the County. The County owned fiber represents approximately 5-10% of the WAN connectivity for County facilities. In addition to the County technology department's fiber, Public Works traffic engineering owns a several miles of fiber throughout the county. This is part of the Intelligent Transportation System (ITS). This fiber is expanding as new road projects are completed" (2009 Local Broadband Inventory Survey).

- Polk County:
 - "Public Safety: in the process of implementing a Wireless solution to most facilities outside the City of Bartow Florida to eliminate reoccurring monthly charges for the Board of County Commissioners, Sheriff, and Public Safety. The system is a compilation of Microwave Networks Proteus and Motorola Wireless (2009 Local Broadband Inventory Survey).
 - County: We have a Wide Area Network WAN that serves our Polk County Florida County Government Agencies only. The WAN does include wireless connectivity between some of the tower sites. We do not have a private sector customer WAN. We lease fiber from the City of Bartow and various circuits from Verizon and Brighthouse to extend the WAN to County Government Agencies within Polk County" (2009 Local Broadband Inventory Survey).
- Volusia County: "Leases a SONET ring that it uses for transmission of voice and data between various county locations. The ring loops around the entire county" (2010 Local Broadband Inventory Survey).
- Walton County: "Walton County School District leases a 100 Mbps from Trillion Partners, Austin, TX" (2009 Local Broadband Inventory Survey).

The counties that indicated in the 2009 Survey that they do not operate a Metropolitan Area Network and have no plans to do so include: Clay; Gilchrist County; Glades County; Osceola County ("N/A"); Lee; Pinellas; and St. Johns.

The 2009 Survey shows some counties that operate or plan to operate fiber optic facilities for communications between buildings and other locations: Clay ("maybe in the future"); Desoto; and Osceola. Charlotte County was the only county from the 2010 Survey.

Three jurisdictions indicate use of the MFN service, including:

- Vero Beach: "We connect to AT&T over their MyFloridaNet MetroEthernet service at 10Mbps" (2009 Local Broadband Inventory Survey).
- Islamorada: "Leases a MAN utilizing a State Contract through MyFloridaNet with a

synchronous 3 MB Bonded T1 internet connection between our Administrative Center and our Fire Rescue EOC” (2009 Local Broadband Inventory Survey).

- Sarasota: “Qwest is our primary ISP, directly. There are two Internet connections (4.5Mbps & a 1.5Mbps). One is being replaced this year by MyFiNet (10Mbps) and the other is being eliminated. A secondary ISP will be selected (another 10Mbps) later in the year” (2010 Local Broadband Inventory Survey).

There are a number of collaborative/co-ownership agreements among jurisdictions in place and functioning:

- Osceola County, Osceola Sheriff; and Kissimmee Utility Authority share or co-own fiber optic facilities (2009 Local Broadband Inventory Survey).
- Marion County: “The Transportation Department is working with the state to install fiber along Baseline road from the intersection at SR464 East all the way to the intersection at 441 in Belleview. This fiber will be turned over to OEU [Ocala Electric Utility] to maintain and Transportation is going to lease bandwidth from OEU. Once tied into OEUs existing infrastructure, IT will lease dark fiber that runs from 5601 SE 66th St to 2511 SE 3rd St Ocala” (2009 Local Broadband Inventory Survey).
- Polk County: “Polk County owns fiber optic lines paid and installed to Polk County facilities within City of Bartow Florida. These facilities are connected in a campus environment setup distance. Polk County also leases fiber optic lines within City of Bartow Florida and to City of Ft Meade Florida and Bartow Airbase on Highway 17 between Bartow Florida and Winter Haven Florida” (2009 Local Broadband Inventory Survey).
- The City of Bartow and the City of Lakeland interconnect fiber networks and share an Internet service provider connection (2009 Local Broadband Inventory Survey).
- Coral Gables is also part of the Miami Dade Broadband Coalition. “We are in the process of developing a partnership with the County, other cities, state agencies, schools, universities, hospitals, and other non-profit and for-profit organizations such as the Knight Foundation, Florida Lambda Rail (FLR), and FPL” (2009 Local Broadband Inventory Survey).
- Gainesville Regional Utilities provides electric, gas, water, wastewater and communication/information services in Gainesville/Alachua County, Florida. GRUCom is the communication and information services utility of GRU. GRUCom operates a 315 mile fiber optic network throughout Alachua County (2009 Local Broadband Inventory Survey).
- Osceola County: “Osceola County has an agreement in place between Osceola County and the Florida Turnpike Authority to access their property and to use six (6) strands of

their fiber the entire length of the Turnpike within Osceola County. The new fiber installed along Old Canoe Creek Road would be used to connect Osceola County's Road and Bridge Facility directly to the County's broadband system. The fiber would also be used by the City of St. Cloud to connect one of its fire stations to the St. Cloud Emergency Dispatch System and would allow the Dispatch Centers of Osceola County and the City of St. Cloud to be interconnected on a high speed broadband link if the project below is installed. Another project is in its conceptual phase of design. The route runs from the corner of Old Canoe Creek Road and US 192 into the new EOC/911/Traffic Management Center Building. Some of the land and rights of ways are currently owned by Osceola County. This project would involve the installation of conduit, fiber and equipment between the two locations. If we install the above two projects, we will then have a survivable redundant fiber loop for the Sheriffs' office, the Emergency Operations Center, the 911 dispatch center for Osceola County and the City of St. Cloud and the Traffic Management Center for Osceola County. The third project is in its' project development and engineering phase of design. HDR Engineering is providing engineering services for the Florida Department of Transportation with this project. It involves the addition of a third lane on each side of US 192 from Aeronautical Boulevard in Kissimmee to Holopaw Road within the County. Osceola County and the City of St. Cloud have petitioned the Florida Department of Transportation that when they buy right of way for the road, they will provide a dedicated communications right of way down one side of US 192. That request is currently being designed into the drawings that HDR is producing. This project will connect to the two projects listed above. The fourth project is also in its' conceptual phase of design. The project is a County wide fiber optic backbone. It involves our current fiber optic interconnections, the addition of projects one, two and three listed above, plus the installation of conduit and or fiber along the roads and buildings that are included in our 10 year CIP plan. The County owns some of the lands and rights of way for the project" (2009 Local Broadband Inventory Survey).

- Jupiter: "Internet services are provided via Palm Beach County Fiber connection at 10 Mbit/s. The City of Jupiter operates a fiber network in part via interlocal agreement with Palm Beach County" (2009 Local Broadband Inventory Survey).
- Indian River County, Indian River School Board and the City of Vero Beach have a consortium for fiber optic network use. Indian River County, the School District of Indian River County, and the City of Vero Beach jointly own and operate a fiber optic cable network connecting all schools and major government office buildings and facilities" (2009 Local Broadband Inventory Survey).
- Collaboration between the City of Palm Coast, the County and School Board is "in the pipeline" (2010 Local Broadband Inventory Survey).
- Kissimmee: "The Kissimmee Utility Authority has partnered with the City of Kissimmee

and the Toho Water Authority to build a joint usage wireless network that serves municipal data needs and provides free and premium WiFi access to residents. This is a pilot project covering 2 square miles” (2010 Local Broadband Inventory Survey).

24 Appendix II: Magellan Advisors “Local Government Communications Use and Municipal Broadband Development,” December 18, 2010.

Magellan Advisors provided the following analysis and information for the project:

Annual Operating Costs for Fiber Networking

Annual operating costs vary by jurisdiction and depend greatly on how the network is operated. This will depend on whether the network is used for solely municipal purposes or to carry commercial traffic in instances where the municipality has its own telecom utility. There are generally two categories of operating costs. The first category is O&M (Operations & Maintenance) outside and inside plant. This includes configuration, repair, relocation and other plant operating costs of the municipal network. The second category is O&M on network equipment, which includes maintenance contracts and incidental equipment expenses for network elements. In most cases where telecom utilities exist, O&M will be accounted for under the utility itself. In cases where the municipality is running a network for internal governmental purposes only, O&M is generally accounted for under the Information Technology department or a related internal cost center.

O&M costs can greatly increase in areas of rapid development and construction. Small expenses such as locate services, fiber cuts and repairs increase as a function of linear route miles of fiber. In general, O&M on outside plant increases linearly with route miles of fiber. We estimate O&M in the range of \$100 to \$300 per route mile of fiber per year on municipal networks. On a 100-mile fiber network, this results in an annual O&M expense of \$10,000 to \$30,000 per year. These estimates vary between the \$100 and \$300 per route mile, per year figures, based on internal and external variables. Internal variables include:

- Network service
- Customer type
- Intelligent traffic systems applications
- Public safety applications
- Collaboration applications
- Video applications
- Utility applications (SCADA, Telemetry)
- Wireless applications (800MHZ, 700MHZ, WiFi, WiMax, LTE)

External variables include:

- Geography and terrain
- Land development

- Local capital projects (road, water and sewer construction)
- State and federal capital projects (FDOT, Florida Turnpike Enterprise)

Government Applications Being Supported with Fiber Optic Networks

Local governments are leveraging fiber networks now more than ever as their reliance on fast, secure, and always-on connectivity increases. These organizations are using these networks to transport data, voice and video traffic, supporting various initiatives in the areas of public safety, utilities, wireless deployments, data-sharing, and collaboration with neighboring jurisdictions. Municipal owned fiber networks are providing a sense of “futureproofing” for the communities they serve in that the infrastructure deployed for today’s needs will support future initiatives. These networks are also driving down the cost of doing business for regions that take a collaborative approach to municipal fiber deployment. Cities, counties and local anchor institutions are able to consolidate and purchase services such as Internet, voice, co-location, hosting, disaster recovery and other network services from one another and in some cases cloud-based services such as e-mail, server virtualization and ERP applications. A list of the most common applications supported on municipal fiber networks include:

- a) Public Safety
 - i) Video surveillance
 - ii) Computer aided dispatch (CAD)
 - iii) Records management
 - iv) Collaboration between agencies – local, state, federal
 - v) Wireless applications
- b) Public Works
 - i) Intelligent traffic systems – Timing/Signalization/Smart Signs
 - ii) Red Light Cameras/Speed Cameras
 - iii) Video traffic/route surveillance
 - iv) Emergency management
- c) GIS
 - i) Online plan submittal, review and approval
 - ii) Online GIS mapping
- d) Utilities
 - i) Water/Sewer/Electric Utility Communications (SCADA)
 - ii) Automated Meter Reading
 - iii) Smart Grid Applications
 - iv) Wireless applications
- e) Information Technology

- i) General IT Services (WAN Communications)
- ii) Voice Over IP
- iii) Video
- iv) Disaster Recovery
- v) Infrastructure Sharing
- vi) Emergency Management
- vii) Wireless applications

Sharing Opportunities That are Enabled between Jurisdictions by Fiber Communications Networking

A good example of collaboration enabled by fiber is the network developed in Seminole County, Florida. In Seminole County, all seven municipal police departments operate on the Sheriff's Records Management System and Computer Aided Dispatch (CAD) system. This sharing of application resources from the Sheriff's Office is only possible through the existence of a county-owned fiber optic network that enters each municipal police station. By leveraging the same Records Management System and CAD system, law enforcement activities have been streamlined and enhanced throughout Seminole County. Additionally, by providing each municipality access to their systems, the cities were able to reduce their law enforcement operational budgets by eliminating the need to license and support their own Records Management Systems and/or CAD systems.

Additionally, Seminole's public works department has effectively networked traffic camera data from neighboring counties and FDOT to provide real-time traffic video streams to the local traffic management center. The large concentration of video streams is distributed across Seminole's extensive fiber-optic network with interconnections to neighboring counties and FDOT.

In Palm Beach County, the extensive fiber optic network operated by the county is being leveraged to deliver FLR services to municipalities within the county. Without access to the county's fiber optic network, the cost to acquire the “last-mile” infrastructure to connect to FLR would be cost-prohibitive. By leveraging County fiber, the cities are able to purchase IP, peering, and transport services from FLR at a much lower rate than what was commercially available, reducing operational expenses while improving overall technical capabilities.

In Lake County, the City of Leesburg's network has provided interconnection of the majority of the School Board sites, including schools and administration buildings. They operate at 100Mbps or greater, providing direct interconnection between schools and administrative services.

What gaps exist in current communications networking? What barriers impede these gaps from being filled? What are the most cost effective ways (whether with private or public sector

facilities) for filling these gaps and why?

The goal of ubiquitous government broadband services in Florida remains a business proposition to the incumbents and cable companies, and understandably, without the revenues to show a reasonable return, broadband will be deployed only where anchor customers can support the required initial investment. Local governments (cities, counties, school districts, constitutionals and utilities) are the key anchor customers for the telecoms and cable companies in smaller markets (tier 2 and 3). Beyond a market of small local businesses, these are generally the largest users of telecommunications services in the tier 2 and 3 markets.

Tier 2 and 3 markets operate differently than larger markets. The decision to “build out” in larger markets is based on demand aggregation that forecasts enough customer uptake to meet the required return, a mix of small, medium and large businesses. Generally, density is high enough to warrant the investment. Demand aggregation in the smaller markets is more difficult to forecast as there are fewer customers who are generally smaller in size. Resultantly, revenue forecasts are limited to the anchor customers, generally local governments and a collection of small businesses in the proposed service area.

As a result, the business model is significantly weighted toward a single anchor customer’s (local government’s) ability to pay the MRC required for the telecom or cable operator to meet the required return. In many cases we have seen the anchor customer foot the bill for the entire market, becoming the sole source that guarantees the minimum return on investment for the provider. Additional customers represent incremental revenues above the initial cost of the last-mile construction and/or backhaul. In cases where last-mile construction or backhaul is needed to reach an anchor customer, there is generally a market for additional customers enabled by these new network resources. This concept varies from market to market but, in general, last-mile construction and backhaul are intended to service more than a single customer in smaller markets.

This is one reason broadband pricing is skewed for local governments in smaller markets. The uncertainty of incremental revenues from new customers results in the anchor customer paying the lion’s share of the provider’s initial investment, through unusually high installation fees and/or an MRC significantly higher than more dense markets. This “broadband access gap” is not easily bridged as the source of the skewed pricing is baked into the business models of the telecoms and cable companies. However, providing an alternative last-mile outside of the telecom and cable networks may provide a tool to bridge the “broadband access gap.”

There is a vast amount of municipally owned fiber network throughout the State of Florida, owned and operated by cities, counties, school districts, constitutionals, public safety organizations, and utilities. In many cases, network assets are suitable and available to provide last-mile resources to service providers or to other municipal organizations directly. In other

cases, these assets are “closed” to commercial services, for various reasons, described below.

Policy and Regulatory Issues

- FDOT state policy legislation on use of ITS fiber communications infrastructure
- FDLE state policy legislation on the use of public safety fiber communications infrastructure
- Federal Highway Administration federal policy legislation on use of ITS fiber communications infrastructure
- Utility regulation concerning the security of control and telemetry data on fiber infrastructure
- Lack of clarity on state legislation concerning municipal telecommunications utilities (Florida House Bill 1322 applicability to dark/lit fiber and transport services)

Organizational Issues

- Joint ownership issues between local organizations owning fiber infrastructure
- Ownership issues within the organization itself (i.e. between a electric utility entity and the respective local municipality, who owns the assets and who has control)
- Lack of resources and/or capabilities to manage a commercial fiber-based network

Technical Issues

- Inadequacy of existing fiber infrastructure to provide commercial services
- Lack of mapping information on location of fiber infrastructure assets
- Lack of technical standards in network construction and operations

Of the three categories, policy and regulatory issues represent the largest obstacle to local government provisioning of networks for commercial services. In the majority of cases, public organizations who look to become providers of dark or lit fiber last-mile services can overcome most organizational and technical issues however, regulatory and policy issues as described earlier become significant challenges and most organizations will not move forward without significant legal and political backing.

For public organizations that have entered the market, great strides have been made in equipping their communities with fiber-based last-mile services. Public organizations have embraced two service models, a more traditional dark fiber “closed access” model and a more comprehensive lit fiber “open access” model. The model chosen depends on many factors, including the geography, demographics, network topology, organizational capabilities and capital

requirements.

The “closed access” model was used (and still is) by public organizations by leasing dark fiber services to other local government organizations directly or to service providers, allowing them to extend their networks to reach local governments (as well as businesses and residents) in the area. Spare capacity in municipal networks is used to create dark fiber spans between locations or into service provider interconnects. This model allows local government customers (and service providers) to have unrestricted access to the fiber provided to them, giving them the right to manage and increase capacity at their sole discretion.

“Open access” has become a more popular model in recent years as networking technologies have simplified the concept of public organizations providing lit fiber services. Whereas “closed access” provides dark, unrestricted fiber strands to the customer, “open access” provides lit fiber “circuits,” generally provisioned as Layer 1 or 2 services, using options such as Ethernet + MPLS, Ethernet + VLAN or in some cases SONET. The key difference is that the end customer is part of the network transport system rather than isolated by physical, dark fiber.

This has several implications for both customers and service providers that makes open-access a compelling model for public organizations who want to provide last-mile services in their communities. First, it allows public organizations to provide multipoint services for customers instead of point-to-point dark fiber links. Using this model, a municipal open-access network can provide a multipoint network to all schools in the service area, enabling them to communicate between each other, simplify their wide-area networking, and reduce their operating costs. Second, it allows public organizations to aggregate customers onto a common infrastructure instead of partitioning customers off on individual dark fiber segments. This has two important effects. First, it allows the municipal network to increase local demand aggregation on the network, which can aid in attracting new service providers to the local market. Second, it expands consumer choice for local broadband by allowing customers to select their desired provider on the common infrastructure from the pool of providers that operate on the open access network.

Both models require local governments to construct new last-mile fiber infrastructure. The cost incurred is significant, particularly in smaller, more rural markets. Local government’s propensity to incur these costs is determinant on the financial condition, budgetary allocation, required return and political climate of the organization. In many instances, local governments who aggressively pursue broadband in their communities develop sound business cases to build, on a project-by-project basis. They may start with small projects that have a quick payback and incremental revenues that can be reinvested in additional construction projects. The entity uses these reinvested revenues to continue network build-out, always ensuring a feasible payback period and new incremental revenues. The model is similar to the model telecoms and cable

companies’ use in their construction projects. The difference is that a percentage of the profits are reinvested back into the networks to further capitalize them, expanding services to the local community.

Each model differs in financial requirements but both models empower local governments to capitalize the last-mile with existing municipal assets. Instead of waiting for telecoms and cable companies to build-out and provision broadband access required in these markets, local governments can sidestep the process and light their communities with direct fiber last-mile infrastructure. When local governments own telecommunications infrastructure they have the ability to deploy their networks with the community’s best interest in mind. They are able to serve areas incumbents have left behind, as profitability is not the main driver behind build-out. This is the key differentiator in municipal broadband.

What opportunities exist for further collaboration and sharing of communications network facilities? What barriers impede that collaboration?

Looking to the future, broadband infrastructure has the capability to facilitate collaboration beyond local metropolitan boundaries. If unused fiber optic infrastructure were made available for governmental use (all levels of government), it would practically eliminate the current need to overbuild additional fiber-optic facilities. Fiber is already in place along nearly all of the major interstates and highways in the State of Florida. If local and state governments were able to leverage this existing infrastructure, collaboration and innovation would be significantly improved. Local governments have not focused toward these collaboration goals due in part to the fact that no far-reaching backbone currently exists.

Regional Governmental Networks

Inter-agency communications networks that consolidate regions of Florida and enable key network services within and between regions, aggregate information and provide long-term technology direction on a regional basis, rather than at only the state or local level. These networks could be used not only for governmental services, but as a regional platform for commercial telecommunications services over which telecoms, cable companies and other service providers could have longer reach into regional markets, particularly tier 2 and 3 areas that are less-than-well served. These networks would have interconnects with SUNCOM facilities for transport, IP and other DMS-provided services as well as other key government and education networks such as Florida Lambda Rail. They would also have facilities in key data center and co-location sites in other regions and within. Autonomy, privacy and security of local government networks would remain intact to ensure independence of local jurisdictions.

Of course, these types of networks would have long-term impact to the business models of the telecoms and cable companies if they were to carry commercial services, particularly if non-

facilities based carriers were now able to access markets otherwise closed to them. If these carriers were able to access tier 2 and 3 markets that were otherwise closed, due to lack of access facilities or “tariffed” local loops that made it prohibitively expensive to provide services to the local area, they would present real competition to the incumbents and cable companies.

However, for the markets served by the Regional Governmental Networks, this would bring additional choice in providers to the local markets while likely putting downward pressure on prices. It would present a paradigm shift in access (backhaul and local loops) to local markets and to the business models of the telecoms and cable companies, which will likely be met with resistance if Regional Governmental Networks were “opened up” to provide commercial services.

Some of the applications that Regional Governmental Networks would enable include:

- Public safety integration – integration between federal, state and local agencies
- Regional emergency management coordination
- Regional business continuity/disaster recovery applications
- Interagency communications – Multiple applications for multiple departments
- Application sharing and volume purchasing between agencies

What economic development opportunities exist from further collaboration and sharing of communications network facilities? What “success stories” can be shared?

When local governments have control over their local telecommunications networks, they are able to make decisions regarding the infrastructure that are in the best interest of the community. This includes the ability to leverage the infrastructure to provide telecommunications services to commercial entities that are located within the area or those that are looking to relocate to the area.

These community-operated networks have several economic development advantages over the telecommunications networks run by traditional providers. First, the local governments can use these networks as incentives for prospective businesses looking to relocate to the area. They no longer need to rely on the local incumbent or cable company to become a community partner in economic development initiatives; the local government owns the network and therefore can make decisions on how to attract and retain businesses. Second, the dollars spent on services purchased over the community network remain local. Local governments that operate community-based networks reinvest the revenues generated from network services back into expansion of the network, related economic development projects and/or general fund contributions.

Community networks grow organically and local governments have significant leverage over how and where these networks grow in their communities. Jurisdiction over local right of way, land use policy and development allows local governments to construct broadband infrastructure in conjunction with other community projects, enabling the networks to grow with local development and grow at a significantly reduced cost. For example, aligning outside plant fiber construction with municipal capital projects such as road construction allows local governments to build infrastructure at a significantly reduced cost by “piggybacking” on the road projects. Adding conduit and fiber to an open road project allows broadband infrastructure to be installed for about one tenth the cost of doing so without the road project. Similarly, local governments often times partner with local developers to ensure that basic infrastructure (conduit, pull boxes, vaults) is installed with their projects, enabling new business and residential developments to be equipped with basic infrastructure from day one.

These initiatives allow municipal broadband networks to grow with low costs and grow as the local community develops. An example of this concept is found in the City of Palm Coast’s FiberNET network, one of Florida’s only open-access networks. Approximately five years ago, the city adopted language into its land development code that required any capital project or development to include basic broadband infrastructure (conduit, pull boxes, vaults). For road, water, sewer or private development projects, this infrastructure was included in the design and construction with the project. Concurrently, the city began building fiber network in areas not covered by these projects. After five years, the city has more than 50 miles of municipal fiber, reaching all city facilities and eliminating all city telecommunications transport costs between its locations. In addition, the city has the potential to provide direct connectivity to other local governments in the area, including the county, school board, sheriff, constitutionals and others and is actively exploring these options.

Beyond local government services, the city has begun operating as an open-access transport provider, providing direct fiber to businesses within the city and interconnecting service providers on its network to reach these businesses. Service providers deliver business Internet and voice services to customers over the FiberNET “local loop.” The result for local businesses provides additional choice in service providers and reduced telecommunications costs.

The economic development benefits of Palm Coast’s FiberNET network are only just beginning to show. The city has been able to attract new business to Palm Coast through its aggressive economic development initiatives, which include advanced local broadband. The city’s largest employer made the decision to relocate its headquarters to Palm Coast in part due to direct fiber access into its facility. An Internet-intensive business, the company needed high-speed, stable and redundant Internet connectivity. FiberNET provided the needed capacity directly to the company as part of the deal for relocation to the Palm Coast area. The city doubled the size of its largest employer and brought an additional 1,000 jobs to the area.

25 Appendix III: Gainesville Regional Utilities/GRUCom

The paragraphs below comprise a description of GRUcom, provided by GRUCom, in response to the 2009 Local Broadband Inventory Survey conducted by DMS.

Gainesville is the largest city and county seat of Alachua County, Florida. Gainesville is primarily known for being home to the University of Florida, the largest university of the State University System of Florida and the third-largest university in the U.S. Santa Fe Community College, one of the nation's largest community colleges, is also located in Gainesville.

As of the 2000 census, the city encompasses 48.2 square miles and has a population, of 95,447, with 37,279 households and 18,341 families residing in the city, which equates to a household density of 773 households per square mile.

The City of Gainesville d/b/a Gainesville Regional Utilities (GRU) is a municipal corporation of the State of Florida. GRU provides electric, gas, water, wastewater and communication/information services in Gainesville/Alachua County, Florida. GRU is the fifth largest municipal electric utility in Florida. GRU provides electric, natural gas, water, wastewater and telecommunications services to approximately 89,000 retail and wholesale customers in Gainesville and surrounding unincorporated areas.

GRUCom is the communication and information services utility of GRU. GRUCom operates a 315-mile fiber optic network throughout Alachua County. The network is primarily used to provide communications and information services to the city and GRU. For example, a primary use of the fiber network by GRU is to connect equipment at the electric substations to the System Control Center for control and data acquisition (SCADA) purposes. Primary use of the fiber network by the City of Gainesville General Government is to interconnect City Hall with various City agency offices and facilities around Gainesville. GRUCom also uses the fiber network to provide local access Metropolitan Area Network (MAN) transport services for other government agencies, private local businesses, information service providers and telecommunications carriers. Local access MAN transport services are utilized in a variety of ways, such as to connect the university hospital to its surrounding clinics, to connect off-campus departments to the main university campus, to connect the local public schools to the school board administration center, to connect the local library branches to the library district administration headquarters, to provide local businesses the ability to interconnect their office locations, to provide last-mile access to local information service providers, and to provide communication tower backhaul to wireless telecommunications carriers. GRUCom also provides public safety trunked radio services (police, fire, etc.), Internet access services, data center co-location and communication tower space leasing services. GRUCom provides all of these services under the authority of the Florida Public Service Commission, which has licensed GRUCom as an Alternative Access Vendor and as an Alternative Local Exchange Carrier.

GRUCom has a 1 Gbps connection to the Atlanta TELX facility, where it is connected to two Internet access providers.

GRUCom has a 315 mile fiber distribution network generally located within the metropolitan area of Gainesville, FL.

In 1994 GRU partnered with Shands Hospital (Gainesville, FL) to construct a fiber ring around the community to provide a high bandwidth infrastructure for communications transport between GRU facilities and Shands Clinics. The effort to construct this network was due to the inability to secure the network services from the Incumbent Local Exchange Carrier, BellSouth (now AT&T). In addition, FCC actions created a requirement to vacate the 2GHZ microwave system in compliance with frequency allocation to the emerging PCS market. In August of 1995 GRU was granted an Alternate Access Vendor or Competitive Access Provider license by the State of Florida PSC. With this capacity GRU formed GRUCom for the purpose of maintaining, monitoring, and marketing of this fiber network for the benefit of both the Public and Private Sector. GRUCom has since actively provided Competitive Access Provider Services and has interconnected with the majority of InterExchange Carriers serving the area in order to facilitate WAN connectivity in the Gainesville market. In December 1996 GRUCom secured a CLEC license from the State of Florida PSC, primarily in order to serve Off-Net sites with Unbundled Network Elements (UNE) from BellSouth as allowed by the Telecom Act of 1996. An Interconnection Agreement was executed with BellSouth (now AT&T) in March 1998 with the right to operate as either a Reseller or as a Facilities-Based Provider.

The GRUCom network now consists of 300 miles of fiber optic cable with varying numbers of fiber under the sheath up to 144 count fiber in certain runs. The network is generally designed utilizing primary and subtending rings. Fiber transport services are provided for other carriers and commercial customers utilizing both the SONET and Ethernet protocols. SONET services range from DS-1 (1.544 Mbps) to OC-48 (2.5 Gbps). Ethernet services are typically provided as 10 Mbps, 100 Mbps or gigabit drops off of a 1 Gbps ring or a 10 Gbps ring. Where GRUCom fiber does not reach all of a customers [sic] locations, BellSouth (now AT&T) UNE's or their Metro Ethernet product may be utilized to connect these remote customer locations.

GRUCom is also an Internet Service Provider and provides Internet access to both commercial and residential customers. Internet access to commercial customers is typically provided over GRUCom fiber or over UNE's purchased from AT&T. Residential Broadband Internet (RBI) services are provided primarily to residents in multi-family dwelling units. GRUCom does provide RBI to several single-family home locations, two are true fiber-to-the-home (FTTH) and one is in conversion from VDSL to FTTH. These services are delivered as switched Ethernet. However, GRUCom also operates a dial-up Internet service.

GRUCom's Ethernet services is delivered via an Active Ethernet platform.

GRUCom leases tower space for antenna collocation on 11 communication towers and two water towers. Leases are primarily with cellular telephone companies serving the Gainesville area. In addition to leasing the tower space, GRUCom also provides fiber transport services to the cellular telephone companies to their cell sites with their main switch locations.

GRUCom operates the Public Safety Radio system in Alachua County, used by all City and County public safety agencies, as well as the University of Florida Police Department. The system operates from five tower sites. The tower sites are connected by GRUCom fiber for ground transport of communications between towers and back to the Alachua County Combined Communications Center.

GRUCom owns a 4,000 square foot, carrier class Central Office. In addition to serving as the main node on the fiber optic network, a portion of this facility has been made available for collocation of equipment by GRUCom customers.

Our fiber network is planned and engineered to provide for future needs based on a case by case analysis. We have no “spare dark fiber.”⁷⁴⁴

⁷⁴⁴ GRUCom Response to 2009 Local Broadband Inventory Survey Conducted by the Department of Management Services.

Below is a table of GRU.COM Fund amounts by years 2005-2009.

Table 25-1. GRU and GRU.COM Financial Information

GRU and GRU.Com Revenues per Bond Resolution	2009	2008	2007	2006	2005
Sales to Customers	\$10,162,231	\$10,277,819	\$9,275,084	\$8,722,084	\$8,565,405
Transfers to Rate stabilization					
	\$(958,870)	\$(1,085,755)	\$(1,691,798)	\$(1,036,283)	(5,391)
Interest Income	\$417,145	\$239,050	\$155,735	\$133,002	\$79,455
GRU.com Operating Revenue					
	\$9,620,506	\$9,431,114	\$7,739,059	\$7,818,803	\$8,639,469
Total GRU Fund Revenue	\$363,585,373	\$352,615,563	\$297,747,273	\$292,422,154	\$254,112,058
GRU.com Total Revenue as percent of GRU Total Revenue	2.65%	2.67%	2.60%	2.67%	3.40%

Source: Gainesville Regional Utilities *Annual Report 2008-2009*, 52.

GRU.Com Statement of Revenue and Expenses	2009				
Sales to Customers	\$10,162,231				
Transfers to Rate stabilization	\$(958,870)				
Other	\$53				
GRU.com Operating Revenue	\$9,203,414				
Operating Expenses	\$(4,866,185)				
Depreciation	\$(3,146,890)				
Operating Income	\$1,190,339				
Non-Operating Items	\$(1,380,953)				
Net Income	\$(190,614)				

Source: Gainesville Regional Utilities, *Annual Report 2008-2009*, 62.

26 Appendix IV: MFN Critical Applications and TRW Schedule IV-C, Agency Impacts of Downtime

DMS describes critical applications over MFN as follows:

MFN provides services to more than 150,000 users. Its core users are the State of Florida agencies, but it also provides services to various counties, cities, municipalities, and non-profits. MFN delivers - in addition to typical network computing tasks (e.g. browsing the Internet, reading e-mail, file sharing) - statewide connectivity to crucial enterprise applications as well as facilitating public access to all state services. Examples include: FLAIR, Florida Crime Information Center, Florida Driver License Information System, Home SafeNet, and Florida Unemployment Internet Claims.⁷⁴⁵

Additional critical applications provided over MFN⁷⁴⁶ are listed by agency below:

- Department of Management Services
 - a. Florida Interoperability Network: provides secure interagency and interoperable communications for Florida's entire community of public safety users with dissimilar systems;
 - b. Next Generation 911: several counties' PSAPs are operational on the MFN where 911 calls and data are received and routed to the appropriate PSAP
- Florida Department of Law Enforcement (FDLE)
 - a. Florida Crime Information Center/National Crime Information Center: FDLE and all law enforcement officers utilize this application to search individual's criminal history record
 - b. VoIP Telephony: Voice over IP telephone system operates out of the headquarters facility and supports users at headquarters and remote sites. VoIP is heavily dependent on MFN for providing stringent quality of service controls, service level agreements and uptime.
- Highway Safety and Motor Vehicles
 - a. Florida Driver License Information System: allows driver license examiner to process driver licenses, identification cards, and administrative hearing applicants
 - b. Florida Real Time Vehicle Information System: allows tax collector and department personnel to process vehicle and vessel title and registration applications
 - c. Computer Aided Dispatch: supports database system where all CAD records

⁷⁴⁵ Ghini, *Renewal versus Rebid of the MyFloridaNet Contract*, 1.

⁷⁴⁶ *Ibid.*, Attachment 14.

- from Highway Patrol's seven dispatch centers are stored for global reporting
- d. SmartMCT/CAD: A database containing all calls for service from the public to the Florida Highway Patrol and 12 other state law enforcement agencies. System tracks all calls from start to final disposition. System is integrated with Mobile Data Systems and Automatic Vehicle Locator systems.
 - e. Current Traffic Conditions - Public web site for showing traffic incidents by region. Data is transferred from the vendor to the highway safety web server periodically.
 - f. FHP and DL Phone Systems - Remote Phones Systems that provide phone communications for the FHP and DL remote offices.
- Department of Children and Families (DCF)
 - a. Home SafeNet (HSn)/Florida Safe Families Network/SACWIS provides an automated information system for the documentation and tracking of activities related to child abuse and neglect reports received by the Florida Abuse Hotline, Child Protection Investigations, and basic care management. This system provides support for front-line workers (department staff and community workers) and managers, the automation of forms, records and reports.
 - b. National Child Abuse and Neglect Data System reports are produced using data collected in HSn. HSn has replaced the functions of the following systems; Client Information System-Child Welfare/Community Based Care Program and Florida Abuse Hotline IS. DCF, using state funds, included functionality for Adult reports of abuse and exploitation. The documentation of investigations and assessments of immediate safety, and long-term risks. Interfaces with Hotline Phoenix, imports ICWSIS Client Data, and Image Management Systems Child Picture URL.
 - c. The FLORIDA On-line Recipient Integrated Data Access System provides operational support for public assistance and child support processing. It serves the working poor, children, and elderly citizens of the state who are eligible for public assistance, medical assistance, and child support enforcement services. Interfaces with Social Security Administration, Florida Lottery, Immigration and Naturalization Services, IRS, Florida Association of County Clerks, Florida Department of Law Enforcement, Department of Education, Department of Corrections, Florida Retirement System, FMMIS (Medicaid) Citibank (EBT) and the Agency for Workforce Innovation.
 - d. Substance Abuse and Mental Health System (SAMH) receives data from multiple record types both from Web enabled data entry and uploaded batch files from state facilities and private providers. SAMH interfaces with Medicaid Eligibility, Medicaid Paid Claims, ADM Provider System, ADM Forensic Database, and imports Medicaid Eligibility information, Admin and SA provider files, HHS

ICD-9 codes. Exports mental health data for federal reporting and Community Based Care provider report information.

- Agency for Workforce Innovation (AWI)
 - a. FLUID (Florida Unemployment Internet Direct Claims) - Provides Florida citizens the ability to file initial claims and continue claims on their unemployment. MFN ties in with connectivity between our downtown building and the SSRC / Mainframe.
 - b. Digital Appeals - Application that interfaces with the Mainframe for AWI telecommuters and onsite agents at various facilities around the state to facilitate challenges to unemployment claims and mediated conference calls between employers and employees.
 - c. One Stop Service Tracking - The workforce board side which manages claims for unemployed citizens and assists citizens with re-joining the workforce.
 - d. VOIP Telephony - A centralized design with our Cisco VOIP system running out of the HQ facility and supporting users both at the HQ and at all remote sites. Voice system heavily dependent on MFN for providing stringent quality of service controls, Service level agreements, and uptime.

Table 26-1 summarizes TRW's "Exceeded downtime impact" reporting.

Table 26-1. Agency Impacts of Downtime

Source: TRW FY 2010-11 Schedule IV-C: Information Technology Costs & Service Requirements

Agency Impacts of Downtime	
Agency	Exceeded Downtime impacts
Administrative Hearings	LAN services are provided to district offices throughout the state; inability to access network would prevent employees from accessing IT systems and would impair their ability to respond to inquiries from parties to cases. WAN services provide connectivity between the headquarters in Tallahassee and the district offices. Inability of the district offices to access the WAN would prevent employees' access to email, Division websites and production SQL servers.
Agriculture	The WAN provides backbone connectivity between the Department's facilities throughout the State and allows access to central computer applications that support strategic Department services. Significant down time would reduce affected field offices' ability to answer and respond to emergency situations. Due to the emergency nature of the Department, this down time may result in life threatening situations.
AHCA	Users will not be able to complete work assignments required for service to the citizens of Florida. Medicaid data may not be available or as up-to-date as it should be; Medicaid information promised to citizens through internet interface might be unavailable or inaccurate; AHCA management might not have access to information required to fulfill executive or legislative requests. Many private businesses that use our information might be adversely affected.
Attorney General	The WAN provides backbone connectivity between the Agency's facilities throughout the state and allows access to central computer applications that support strategic Agency services. If users lose access to data and the Internet, this could have an adverse impact on cases such as: inability to respond quickly in pending death penalty cases; inability to complete timely electronic filing of court documents; inability to support price gouging hotline during statewide emergencies; and significantly reduce field office efficiency.
AWI	Unable to process Unemployment Claims & Benefits; Unable to process Regional Workforce Boards request for award drawdown

Source: TRW FY 2010-11 Schedule IV-C: Information Technology Costs & Service Requirements

Agency	Exceeded Downtime impacts
Children and Families	The LAN service provides backbone connectivity in each of the department's facilities throughout the state. Staff utilizes the WAN/LAN in some way to provide virtually all services provided by the department. If the WAN/LAN service is unavailable, department staff would have difficulties providing services to clients, access strategic applications, share automated data, run e-mail, and communicate information on-line.
Citrus	NA
Community Affairs	Degradation of ability to perform statutory requirements
Corrections	Public Safety at risk
DBPR	The Network Service provides backbone connectivity between the department facilities throughout the state and allows access to central applications that support strategic services. Significant downtime during work hours would prohibit affected field offices' ability to perform essential job functions, prohibit employees from accessing strategic IT systems and reduce the ability to provide direct services to citizens.
DEP	Interruption on the agency's ability to carry out it's mission.
DFS	The LAN/WAN and MAN service provides backbone connectivity to each departmental facility throughout the state. If the connectivity is not available, department employees will not be able to access strategic IT systems required to provide direct services to our customers (Floridians).
Disabilities	Loss of work productivity
DMS	Customer service to over 800,000 active FRS Members, 300,000 Retirees, 800 participating Employers, and 300 other vendors would be unavailable. Facilities would have no ability to manage environmental and fire controls of State Buildings. Vendors and purchasers would not be able to access MyFloridaMarketPlace.

Strategic Planning for Florida Governmental Broadband Capabilities
 Volume 2—Appendix IV: MFN Critical Applications and TRW Schedule IV-C, Agency Impacts of Downtime

Source: TRW FY 2010-11 Schedule IV-C: Information Technology Costs & Service Requirements

Agency	Exceeded Downtime impacts
DOE	<p>EDC - Agency personnel experience loss of productivity and potential loss of unprotected network assets and data. Backup of data to offsite location is lost. The WAN provides backbone connectivity among the department facilities throughout the State and enables access to central applications that support strategic services. Significant downtime during work hours would reduce affected field offices' ability to respond customer inquiries about their accounts and provide required levels of service. Staff productivity would suffer dramatically due to inability to access needed documents and information.</p> <p>DBS - Tallahassee LAN would impact 340 users unable to provide services to 12000 clients. Local office LAN impacts users and clients local to that office. The WAN provides backbone connectivity between the department facilities throughout the state and allows access to central applications that support strategic services. Significant downtime during work hours would reduce affected field offices' ability to answer inquiries about their accounts.</p> <p>VR - Service provision to customers is interrupted.</p>
DOR	<p>Taxpayers and recipients of child support will not receive server/information needed. Movement of money in and out of the agency could be disrupted.</p>
DOS	
DOT	<p>The WAN provides backbone connectivity between the department facilities throughout the state. Department employees would not be able to access critical and strategic applications and services. This would result in a significant impact to the department's business processes.</p>
Elder Affairs	<p>Loss of Productivity, disruption of business and service delivery</p>

Strategic Planning for Florida Governmental Broadband Capabilities
 Volume 2—Appendix IV: MFN Critical Applications and TRW Schedule IV-C, Agency Impacts of Downtime

Source: TRW FY 2010-11 Schedule IV-C: Information Technology Costs & Service Requirements

Agency	Exceeded Downtime impacts
FDLE	<p>FDLE productivity is severely curtailed if LAN is inoperable. There is also a wider impact to both criminal justice officer and public safety if investigative, intelligence, and domestic security information is not available. Florida's most critical criminal justice systems operate through the FDLE WAN (known as the CJNet). These systems impact both criminal justice officer and public safety. If the WAN is inactive, criminal justice operations statewide are effected. For example:</p> <ul style="list-style-type: none"> - An officer on the street has no way to access vehicle license plates, driver's licenses, criminal history or wanted files for individuals encountered. - Booking stations have no way to fingerprint, identify and enter information on individuals arrested - or to determine the prior criminal history or active warrants for an individual. - Agencies / companies have no way to perform criminal history checks for assorted licenses and occupations.
Fish and Wildlife	<p>Staff will not have access to critical Law Enforcement, strategic and non-strategic data. This lack of access will impair our ability to conduct Law Enforcement operations and to provide service to citizens.</p>
Gov. Office	<p>No productivity; loss of connection to network resources</p>
Health Department	<p>Communications and administrative support services are interrupted</p>
Juvenile Justice	<p>Mission critical business data cannot be updated and available online/real time to all authorized DJJ, Law Enforcement, and Provider staff. The Juvenile Justice Information System is a web based on-line real-time system that processes data on juveniles through the entire juvenile justice continuum. Without the availability of the desktop service, staff and providers cannot access and update juvenile data and criminal justice partners will not have access to current juvenile data. This can result in juvenile, staff and public safety issues.</p>
Lottery	<p>Network provides access to all gaming monitoring, auditing and management functions. Any downtime could impact sales or gaming integrity. Note that service is available 24/7 but maintenance can be scheduled and performed, if needed, between 0030 and 0530.</p>

Strategic Planning for Florida Governmental Broadband Capabilities
 Volume 2—Appendix IV: MFN Critical Applications and TRW Schedule IV-C, Agency Impacts of Downtime

Source: TRW FY 2010-11 Schedule IV-C: Information Technology Costs & Service Requirements

Agency	Exceeded Downtime impacts
Military Affairs	All facets of the agency's business would be impacted, to include agency communication, pay,
Public Service Commission	Most agency activity stops when the LAN service is unavailable. PSC staff require access to email / calendaring, agency specific applications, shared data files and the Internet. All of these services are delivered using the LAN.
State Courts	Problems could occur with the criminal justice system process (e.g., delay in video and 1st appearance hearings, legal research access, criminal history searches), court judgments and opinions could be delayed resulting in postponement of sentencing in the courtroom.
Veterans Affairs	Loss of access to vital healthcare information, loss of access to veterans' claims processing information, decreased staff productivity, possible interruption of Medicaid/Medicare and federal per diem reimbursement billing

27 Appendix V: Florida Network Technical Attributes

Table 27-1 compares the various technical attributes of Florida’s networks and capabilities provided through MFN, FLRNet, FLR Wave, and GRU. To be clear, none of these attributes are cost-free. The capabilities and the services provided by each network cost the providing entity and the end user real money. None of the comparative points should be taken to indicate that one of the networks is the “best network” for all users. Each of the described networks could be “the best” network for a particular set of end user needs.

Table 27-1. Florida Network Technical Attributes

Index	Network	MFN	FLRNet	FLR Wave	GRU	GRU Carrier’s Carrier	GRU Legacy Carrier
1	Description	Backbone Network+access+CPE	Backbone Network	Customer facilitated network	Backbone Network	Service network for carrier	Traditional Carrier Services
1.1	Topology	statewide optical network	1540 miles of fiber optic cable	same	Approximately 300 miles of network.(fiber optic cable, copper)	Towers, Copper	Provides High speed SONET based services. Point to Point. Carrier Services and Public Safety Trunked Radio on network
1.11	Geography	State	State (dependent on distance to FLR POP)	State	County and local	County and local	County and local
1.12	Architecture						

Index				Network	MFN	FLRNet	FLR Wave	GRU	GRU Carrier's Carrier	GRU Legacy Carrier
			1.121	Core	dual carrier class Juniper M320 routers in each LATA-based node	Single core	single core	unknown	unknown	unknown
			1.122	Port	port 56k - 10gig	2 ports, 100meg and 1 gig	1gig - 10gig	port but no detail	port but no detail	n/a
			1.123	Access	Included in bundle or customer can provide	Local Loop provided by Equity members, and affiliates Secured from local carrier.	Each customer is responsible for connectivity to the network infrastructure	Customer provide	customer provided	part of basic service
			1.1231	Frame Relay	Yes					
			1.1232	Ethernet	Yes	Yes		Yes		
			1.1233	Private Line	Yes			Yes		
			1.1234	DSL	Yes			Yes		
			1.124	CPE	Rental purchase or customer provided	customer provided	customer provided	Customer provided	customer provided	customer provided

Index				Network	MFN	FLRNet	FLR Wave	GRU	GRU Carrier's Carrier	GRU Legacy Carrier
			1.125	Attributes	99.999% (“five nines”) availability guaranteed with SLA	The Network has target of 99.999% Availability	The Network has target of four 9's Availability	designed for “five nines”	Designed for “five nines”	Carrier quality “five nines”
			1.126	Characteristics	Multiple access services from 56k to 1 gig.	Dynamic bandwidth allocation	Dynamic bandwidth allocation	General shared Fiber Network	General shared optical network	Traditional carrier SONET
			1.127	Survivability	Very good/Mission critical	good	good	very good	good	good
			1.1271	Node interconnection	a combination of redundant OC-48 (2.4 Gbps) and OC-12 (622 Mbps) packet	1Gbps	1-Gbps&10-Gbps	OC-48 (2.4 Gbps)	Est. 1gig	unknown
			1.12711	Redundant?	yes 4 rings	yes 2 rings	yes 2 rings & peering points	Yes	yes	yes
			1.12712	Speed/Capacity	26 backbone circuits all 10 Gbps	The Network capacity 20 Gbps	Each university has 1 Gbps&10 Gbps lambda wave	at least I gig	at least 2.4 gig	DS1 - DS3

Index					Network	MFN	FLRNet	FLR Wave	GRU	GRU Carrier's Carrier	GRU Legacy Carrier
				1.1272	Links	SONET, Ethernet, MPLS and IP over optical Fiber	Ethernet, MPLS and IP over optical fiber	Lambda, MPLS and IP over optical fiber	Ethernet, MPLS and IP over fiber and Microwave	Optical, lambda, MPLS and IP	unknown
				1.128	SLAs	Yes and penalty for misses	SLA but no penalty	SLA but no penalty	SLA's with each customer. Each type of service will have a different SLA, depending on customer parameters	SLA's with each customer. Each type of service will have a different SLA, depending on customer parameters	SLA's with each customer. Each type of service will have a different SLA, depending on customer parameters
				1.1281	Core	Included dual core	Included Single Core	Core and Peering point for Lambda service	Single core/ dual core	single/dual core	SONET
				1.1282	Access	Included	Provided by Customer	provided by customer	provided by customer	provided by customer	Unknown
				1.1283	CPE	Included in Package or bring your own supported CPE	customer provided CPE	Customer provided	Customer provided	Customer provided	customer provided
				1.1284	Operations	Included	Scaled down version is included	can be provided	yes	yes	yes

Index				Network	MFN	FLRNet	FLR Wave	GRU	GRU Carrier's Carrier	GRU Legacy Carrier
			1.1285	Issue Resolution Standard	4 Hours	Best effort	Best effort	Included metric is unknown	included Metric is Unknown	Unknown
			1.13	Technology	MPLS Network, Broadband optical Network	MPLS Network, Broadband Optical Network	dedicated FLR Wave, Broadband Optical Network	Optical, ETHERNET, MPLS backbone network	dedicated lambda broadband optical network	broadband optical network, trunk radio
			1.131	Transport	multiple transport			Multiple transport		
			1.132	Nodes						
			1.1321	Routers	Dual Carrier class Juniper M320 core routers	Cisco Carrier Class	Included in common network elements	Cisco 6509 multi-layered switches	unknown or N/A	unknown or N/A
			1.1322	Locations	10 LATA-based locations	See FLR Network	See FLR Network			
			1.133	Rings	4rings	2 Rings	2 rings	1 or 2 rings	1 or 2 rings	1 or 2 rings
			1.1331	Type	Dual Core Counter-rotating	Single core counter rotating	single core counter rotating	single core	single core	single core
			1.1332	Trunks						
			1.13321	Speed	622 mbps or 2.4 gig	100 Mbps to 1gig	1gig - 10gig	1 gig	1 gig	1 gig
			1.13322	Number	26					
			1.133	Planned Trunk Upgrade?	Yes, all to 10 gig	Yes, to 10 gig	Yes to 40g	Yes to 10gig	Yes to 10gig	Yes to 10gig

Index				Network	MFN	FLRNet	FLR Wave	GRU	GRU Carrier's Carrier	GRU Legacy Carrier
			1.134	Rings, Core Access	5 options					
			1.135	NMS/NOC						
			1.1351	Dedicated?	Yes	yes - outsources to UF	yes - outsourced to UF	Yes	Yes	Yes
			1.1352	Mirrored?	Yes	No	No	Yes	Yes	Yes
			1.1353	Is Mirrored Live?	Yes	No	No	Yes	Yes	Yes

Source: Public Utility Research Center Compilation from Interviews and Research

Comparative observations and conclusions from Table 27-1 include:

1. MFN provides end-to-end Quality of Service enforced by strong SLA agreements. The other networks do not. SLA's for the other networks take the form of goals and targets, not commitments that if missed, carry financial penalties.
2. All networks except MFN depend on designed under-utilization for their ability to provide high capacity networks.
3. All networks except MFN depend on their ability to increase capacity to provide converged services that drive increased network utilization. The MFN network is designed to ensure that converged services and applications will have no effect on network performance.
4. FLR is the only network that offers lambdas
5. MFN and FLR are statewide networks, while GRUCom is more local.
6. MFN includes local access in its service offering. The others do not.
7. MFN has published pricing for services. The other networks price through contracts that are considered proprietary.
8. MFN and GRUCom allow several access technologies to be used to connect to their networks. GRUCom allows custom connections.
9. MFN allows network connections at speeds ranging from to 56kbps to 1Gbps.
10. FLR uses access speeds of 100 Mbps or 1 Gbps, reflecting the needs of universities.
11. MFN and GRUCom have NOCs with the tools to provide performance monitoring and fault isolation without having to dispatch technicians.
12. The MFN NOC provides network management capabilities to users.
13. The FLR NOC only manages the backbone network because FLR does not include access as part of its service.

28 Appendix VI: Health Information Technology

David Brown⁷⁴⁷

FCC Chairman Kevin Martin notes, “In order to receive the benefits of telemedicine, electronic health care records, and other health care benefits, health providers must have access to underlying broadband infrastructure. Without this underlying infrastructure, efforts to implement these advances in health care cannot succeed.”⁷⁴⁸

28.1 Introduction

Improving America’s health care industry is essential in order to control the rising cost, face the increasing demand with improved life-saving care and mitigate the negative effects of physician shortages. National Health Expenditures already account for 17 percent of U.S Gross Domestic Product and by 2020 it is expected to top 20 percent.⁷⁴⁹ The “rising costs would be less of a concern if there were results. But Americans are not healthy.”⁷⁵⁰ For example, 68 percent of adults are overweight or obese, leading to medical complications⁷⁵¹ and the nation has 670,000 new cases of congestive heart failure each year, many of them fatal.⁷⁵² To reign in these costs and meet the growth in demand, the health care industry needs to couple 21st-century medicine with 21st-century communication technology.

Broadband is not a panacea. Rather, implementing Information Technology in the health care industry, often called Health Information Technology (HIT), offers the potential to improve the quality of care while reducing costs and extending the reach of the limited pool of physicians.⁷⁵³ Furthermore, future innovations will certainly increase the applications of HIT systems. However, there exist several barriers to wide-spread adoption of HIT systems. It is essential that policymakers remove these barriers in order to extract the potential benefits of HIT systems.

The focus of this study is to analyze current and future opportunities for HIT in the US health care industry. In particular, implementing these systems into Florida’s health care industry to improve the states’ quality of care and reduce the escalating health care costs. The section below focuses on the current and future benefits of *wide-spread* HIT adoption. However, the reluctance to adopt HIT systems suggests that there exists barriers to *wide-spread* implementation. The

⁷⁴⁷ Graduate Student, Department of Economics, University of Florida.

⁷⁴⁸ Statement of Chairman Kevin J. Martin, Re: In the Matter of Rural Health Care Support Mechanism, WC Docket No. 02-60.

⁷⁴⁹ Center for Information Technology Leadership, *National Health Expenditure Projections 2009-2019*.

⁷⁵⁰ Federal Communications Commission, *National Broadband Plan*, Chapter 10, Health Care, 1.

⁷⁵¹ Ogden and Carroll, *Prevalence of Overweight, Obesity, and Extreme Obesity among Adults*.

⁷⁵² Center for Disease Control, “Chronic Diseases and Health Promotion.”

⁷⁵³ Federal Communications Commission, *National Broadband Plan*, Chapter 10, Health Care.

following section uncovers the characteristics that are barriers to or facilitators of adoption. This section reveals two main issues: (1) physicians lack the incentive to adopt HIT systems and (2) large investment costs of implementation and management HIT systems. In particular, this is a major barrier in rural regions facing weak broadband infrastructures. Then, section 1.4 focuses on the initiatives for *wide-spread* HIT systems in Florida. Establishing a statewide robust broadband infrastructure is essential in order to construct Florida’s Health Information Network.

28.2 Benefits of HIT

In a recent study by RAND Health, they projected the productivity growth as a result of *wide-spread* implementation of HIT systems to be between 1.5 percent (low-end) and 4 percent (high-end).⁷⁵⁴ The lower improvement implies an annual spending decrease of \$346 billion, and an upper-end decrease of \$813 billion.⁷⁵⁵ In order to realize these productivity gains, wide-spread implementation is essential as a result of the interoperability of these systems.

“By connecting health care providers via broadband, we begin the process of laying the foundation for a digitally integrated health care system. Such an outcome would enable the implementation of a vision that ensures every health care facility, 911 call center, and emergency responder is connected both to each other and to a vast array of life-saving information and expertise.”⁷⁵⁶ *Wide-spread* adoption of HIT systems will lead to substantial innovations in preventive care, chronic disease management, care coordination, and medication management.⁷⁵⁷ This section provides a summary of several important applications and potential benefits of HIT systems.⁷⁵⁸

28.2.1 Preventive Care

Preventive care services are underperformed in the US by as much as 45 percent.⁷⁵⁹ This deficiency is induced by the lack of a “reminder” system which keeps track of the services the patient needs. HIT systems can equip providers and patients with relevant clinical reminders displayed for the provider and patient via dashboards or reports to the provider and automated calls, texts messages, or emails to the patient. Implementation of HIT systems in preventive care will generate substantial improvements in quality, patient health, and lead to cost reductions. For example, “about 54 percent of Americans get appropriate screenings for colorectal cancer, 69

⁷⁵⁴ They predict the benefits to fall on the low-end due to the inherent complexities in the health care industry.

⁷⁵⁵ Hillestad, et al., “Can Electronic Medical Record Systems Transform Health Care?” 1103–1117.

⁷⁵⁶ Federal Communications Commission, *Joint Advisory Committee on Communications*, 60.

⁷⁵⁷ Park and Basch, *Historic Opportunity*.

⁷⁵⁸ Due to the plethora of HIT applications, we are unable to reflect all the applications of HIT in this survey. For a full analysis on all HIT applications see Federal Communications Commission, *National Broadband Plan*, Chapter 10, Health Care; Park and Basch, *Historic Opportunity*; and Federal Communications Commission, *Joint Advisory Committee on Communications*.

⁷⁵⁹ McGlynn, et al., “Quality of Health Care Delivered to Adults,” 2635–2645.

percent for breast cancer, and 81 percent for cervical cancer. Bringing these rates closer to 100 percent would save up to 45,000 lives per year. Bringing influenza and pneumococcal vaccination closer to 100 percent would save up to an additional 39,000 lives per year.”⁷⁶⁰

The use of Electronic Medical (Health) Record (EMR) systems enables consistent delivery of up-to-date information to patients and providers. This system proactively reminds the provider and patient about any current gaps in the patients preventative care regimen. In order to implement such a system, both providers and patients require wide-spread broadband access.⁷⁶¹ It is essential that the patient’s prior providers used EMR systems in order to have a complete view of the patient’s current needs. EMR systems will provide the physician with the life-saving information necessary in implementing the appropriate preventative care.

28.2.2 Chronic Disease Management

More than 75 percent of health care dollars are spent on chronic diseases such as diabetes, hypertension, heart disease, stroke, cancer, pulmonary conditions, and mental disorders.⁷⁶² “This is the area of the U.S. health care system that requires significant improvements more than any other.”⁷⁶³ The use of EMR systems can improve chronic disease management through provider reminders of the patient’s status. Such reminders can lead to improved care and a reduction in avertable complications. For instance, for chronic conditions such as asthma, congestive heart failure, chronic obstructive pulmonary disease, diabetes, hypertension, and coronary artery disease, as much as 40 cents on every dollar are spent on potentially avertable complications.⁷⁶⁴ A patient’s EMR “dashboard” can track their status to determine the optimal course of action.⁷⁶⁵ Also, such EMR systems can be equipped with performance feedback on how the providers are managing their patient’s chronic disease providing them with a rank against their peers.⁷⁶⁶ This creates an incentive structure to improve chronic disease management leading to enhanced life-saving care.

This level of “data visibility” is not possible in an environment where each patient’s data is in a paper chart.⁷⁶⁷ *Wide-spread* HIT-powered chronic disease management will generate substantial

⁷⁶⁰ Park and Basch, *Historic Opportunity*.

⁷⁶¹ Hillestad, et al., “Can Electronic Medical Record Systems Transform Health Care?” 1103–1117.

⁷⁶² Center for Disease Control, “Chronic Diseases and Health Promotion.”

⁷⁶³ Park and Basch, *Historic Opportunity*, 10.

⁷⁶⁴ Francois de Brantes, Prometheus Payment Initiative, Interview 2009.

⁷⁶⁵ Such “dashboards” can provide specific information dependent on the patient’s needs. For example, if the patient has diabetes, the “dashboard” can summarize past test values, show patient blood pressure to alert if it’s too high, show if the patient’s body mass index is too high, etc. The annual savings for improved diabetes care has been estimated to be up to \$6.1 billion. Clark, “Take Two Digital Pills.”

⁷⁶⁶ Park and Basch, *Historic Opportunity*.

⁷⁶⁷ Approximately “90% of health care transactions are conducted by paper, fax, and phone calls - putting the medical system radically out of synch with the way business is conducted in every other sector of the economy ”

improvements in patient care through increased information to providers and patients. A recent pilot program by Kaiser Permanente of Colorado used HIT-powered capabilities in cardiovascular care teams improving the number of patients achieving targeted cholesterol goals by 26 percent to 73 percent of patients. Also in this pilot study, heart attacks fell by 73 percent.⁷⁶⁸ These preventions lead to significant cost savings through a reduction in emergency interventions. This transparency in patient care allows the patient to become more interactive in their chronic disease management and improves providers' care through EMR reminders and evaluation metrics.

28.2.3 Care Coordination

“The fragmentation of the U.S. health care delivery system is well documented.”⁷⁶⁹ Approximately 75 percent of Medicare spending is on beneficiaries with at least five chronic conditions who visit, on average, 14 different physicians per year.”⁷⁷⁰ Each provider acts on their own, leading to inefficiencies through redundancy in care, and sometimes providers make decisions that interact negatively with prior decisions made by a colleague. Thus, increasing coordination between providers can lead to improved care, cost reduction, and life-saving treatment decisions.

Modern broadband communication networks enable physicians to collaborate through EMR systems that include “specific decision-support and connectivity tools to enable consensus and coordinated action among care providers and patients.”⁷⁷¹ Geisinger Health Systems in Pennsylvania uses EMR systems to standardize and automate care processes. Their cardiovascular surgeons developed a best-practice process. The result has increased the percent of patients discharged directly to home to 93 percent from 81 percent⁷⁷² and reduced hospital readmission for bypass surgery 44 percent.⁷⁷³

Also, with sufficient broadband infrastructure, physicians can transfer bandwidth-intense information through video, pictures, and graphics fast and reliably. Such Telemedicine systems are particularly useful in rural regions that are often under-staffed with specialists.⁷⁷⁴

Federal Communications Commission, *Joint Advisory Committee on Communications*, 13.

⁷⁶⁸ Kaiser Permanente, “Kaiser Pilot Results in Reduction of Heart Attack Deaths.”

⁷⁶⁹ Park and Basch, *Historic Opportunity*, 12.

⁷⁷⁰ Congressional Budget Office, *Budget Options, Volume I: Health Care*.

⁷⁷¹ Park and Basch, *Historic Opportunity*, 13.

⁷⁷² Walker and Carayon, “From Tasks to Processes,” 467-77.

⁷⁷³ Connolly, “For This Health System, Less Is More.”

⁷⁷⁴ It is estimated that 37% of rural residents in the US do not have access to a primary care physician.

“Telemedicine is a broad term within (HIT) that encompasses methods for electronically transmitting medical information to sustain and/or improve a patient's health status.” Hein, *Telemedicine: An Important Force in the Transformation of Healthcare*, 4.

Telemedicine offers the opportunity for remote diagnoses, monitoring, and treatment of rural patients. In particular, moving information through broadband networks reduces the need for physical transportation of patients to see specialists. The cost savings for reduction in patient transportation could be as much as \$1.2 billion annually.⁷⁷⁵ By connecting rural patients and specialist, telemedicine can be used to close the current provider shortage and geography gaps. Thus, implementation of a wide-spread broadband network could prompt fast “real-time” collaboration between providers leading to more efficient care, life-saving diagnoses, and reduction in costs through a reduction in redundancy and patient transportation.

28.2.4 Medication Management

“Paper-based prescribing is at best an accurate reflection of the best thinking of the prescribing physician at that moment in time.”⁷⁷⁶ Transition from paper-based methods to electronic methods that are connected to EMR systems will yield substantial improvements in care and prevention of Adverse Drug Events (ADEs) reducing unnecessary health care expenditures and saving lives.⁷⁷⁷ “ADEs are injuries “resulting from an intervention related to a drug” and can be classified as preventable or non-preventable” and are preventable if “errors can be identified in any part of the medication process - prescribing, transcribing, dispensing, consuming, or monitoring.”⁷⁷⁸ The use of electronic prescribing (e-prescribing) systems can optimize prescribing by providing: safety “checks” on drug-to-drug, drug-to-condition, drug-to-age, and drug-to-allergies; cost-effectiveness by switching from brand-name to generic and a reduction in admissions due to ADEs; and more appropriate drug utilization.⁷⁷⁹

In a study by the Center for Information Technology Leadership, it’s estimated that the adoption of e-prescribing methods will reduce more than two million ADEs per year. This will, “avoid nearly 1.3 million visits, more than 190,000 admissions, and more than 130,000 life-threatening ADEs” per year. This reduction in ADEs will lead to annual savings of \$44 billion (in 2002 dollars).⁷⁸⁰ However, their estimates are based upon “advanced” adoption of these systems. Implementation costs rapidly increase with system sophistication, advanced systems cost \$29, 000 (per provider) more than five times as much as basic systems \$4, 500 (per provider) but produce 12 times greater financial returns.⁷⁸¹ Thus, to realize the potential gains from electronic prescribing methods, providers require significant investment, broadband access, and wide-spread adoption of EMR systems.

⁷⁷⁵ Cusack, et al., *Value of Provider to Provider Telehealth Technologies*.

⁷⁷⁶ Park and Basch, *Historic Opportunity* 14.

⁷⁷⁷ Schiff and Bates, “Can Electronic Clinical Documentation Help Prevent Diagnostic Errors?” 1066–69.

⁷⁷⁸ Johnston, et al., *Value of Computerized Provider Order Entry*, 6.

⁷⁷⁹ Shores, et al., “Evolving E-prescribing Landscape.”

⁷⁸⁰ Johnston, et al., *Value of Computerized Provider Order Entry*, 6-7.

⁷⁸¹ Johnston, et al., *Value of Computerized Provider Order Entry*.

28.2.5 Emergency Medical (Health) Records

As discussed above, EMR systems play an integral role in the future of HIT systems. Wide-spread EMR adoption will establish an interconnected nation-wide network providing physicians with an efficient exchange of patient and treatment information. In a 2005 study by RAND, it's estimated that the cumulative potential benefits of wide-spread (90 percent) adoption of EMR systems. "Over fifteen years, the cumulative potential net efficiency and safety savings from hospital systems could be nearly \$371 billion; potential cumulative savings from physician practice EMR systems could be \$142 billion."⁷⁸² While there has been a general consensus that EMR systems will yield dramatic benefits to the health care industry, there has been less agreement on the actual adoption rates of such systems. Dependent on the definition used to define an EMR system, basic and comprehensive EMR system adoption rates range from 7.6 percent to 13 percent and 1.5 percent to 4 percent respectively.⁷⁸³ These adoption rates are far from the wide-spread adoption necessary to observe the interoperability benefits of EMR systems. Also, many local/regional EMR systems are incompatible with neighboring EMR networks. Therefore, it is essential that there exists wide-spread universal EMR systems that will eliminate the current balkanized networks and allow providers to realize the interoperability benefits of EMR systems.

28.3 Broadband Requirements

The adoption of interoperable HIT systems has the potential to substantially improve the health care industry and reduce the escalating costs of care. However, these systems require significant access to broadband networks. The required broadband connectivity depends upon the size and services provided by the health care facility. For instance, the estimated "sufficient" broadband connectivity of a single physician practice is 4 Mbps, while an academic/large medical center requires at least 1,000 Mbps⁷⁸⁴. These broadband needs are intensified by the increasing amount of data files that are collected and transferred via broadband, see Figure 8. "A single video consultation session can require a symmetric 2 Mbps connection with a good quality of service."⁷⁸⁵ Applications that integrate real-time images and live-video stimulates demand for more broadband. For example, real-time video from EMS vehicles to the emergency room can anticipate the patient's needs before arrival greatly improving their chances of survival.⁷⁸⁶ Such IT innovations will improve the U.S. health care system, but a robust broadband infrastructure is necessary to support such systems.

⁷⁸² Hillestad, et al., "Can Electronic Medical Record Systems Transform Health Care?" 1114.

⁷⁸³ Jha, et al., "Use of Electronic Health Records," 1628–1637 and DesRoches, et al., "Electronic Health Records," 50–57.

⁷⁸⁴ Federal Communications Commission, *National Broadband Plan*, Chapter 10, Health Care.

⁷⁸⁵ Federal Communications Commission, *National Broadband Plan*, Chapter 10, Health Care, 209.

⁷⁸⁶ Federal Communications Commission, *Joint Advisory Committee on Communications*.

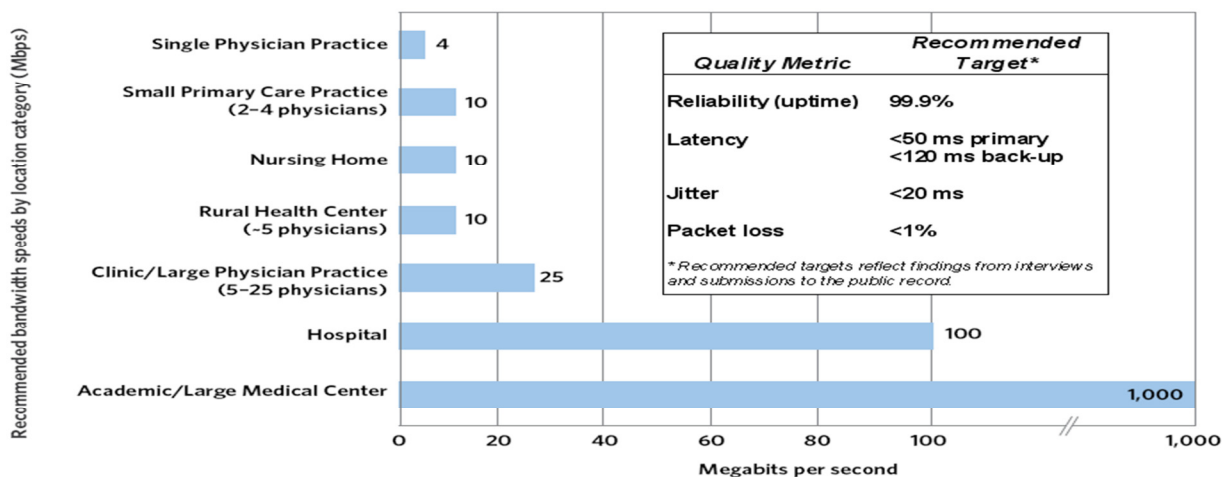

Figure 1. Required Broadband Connectivity and Quality Metrics

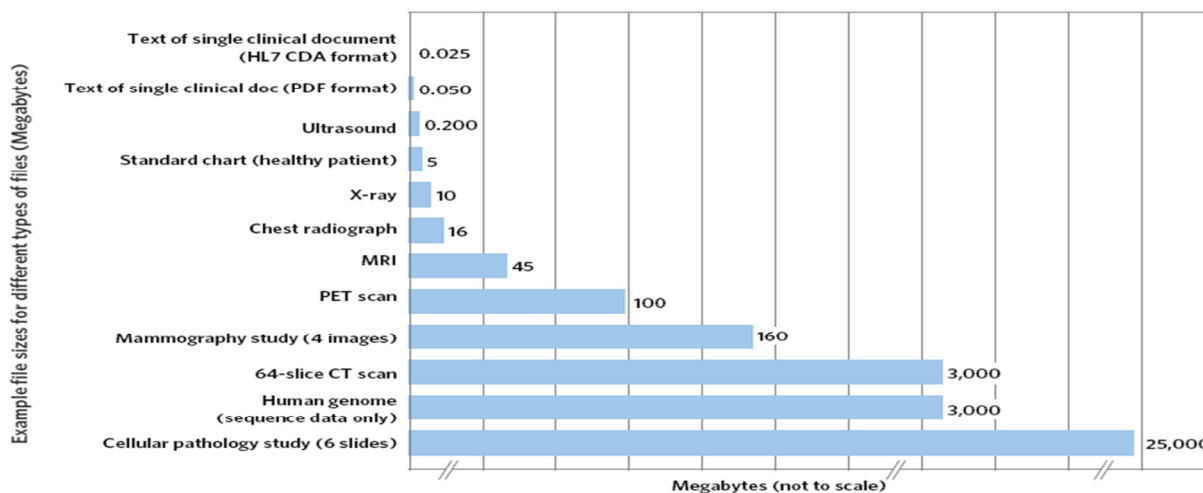

Figure 2. Health Data File Sizes

Source: FCC, 2010

This section discusses the characteristics that encourage and impede HIT adoption: in particular, how insufficient broadband infrastructure and inadequate incentives hinder wide-spread adoption HIT systems. Broadband availability is particularly scarce in rural regions where infrastructure is inadequate and rural providers lack the financial capital and incentive to invest in broadband infrastructure. In order to persuade providers to invest in HIT systems, multiple funding programs have been implemented to remove the high capital costs of infrastructure investment.

28.3.1 Hospital Characteristics

As discussed above, the 10 to 17 percent EMR adoption is far from the wide-spread rates necessary to realize the interoperability benefits of such systems. These low levels of adoption suggest that policymakers face substantial obstacles in achieving wide-spread HIT adoption. A recent study surveyed all acute care and surgical member hospitals analyzing the “hospital characteristics and factors that were reported to be barriers to or facilitators of adoption.”⁷⁸⁷ The most commonly cited factors were:

- Barriers of adoption: inadequate capital for purchase (74 percent), concerns about maintenance costs (44 percent), resistance on the part of physicians (36 percent), unclear return on investment (32 percent), and inadequate expertise in information technology (30 percent).⁷⁸⁸
- Contributing characteristics: reimbursement for EMR use (82 percent), financial incentives (75 percent), availability of technical support (47 percent), and objective third-party evaluations of EMR products (35 percent). Also, those hospitals that were larger, major teaching hospitals, or located in urban areas were more likely to have EMR systems due to economies-of-scale and existence of robust broadband infrastructures.

This analysis provides policymakers with evidence of the obstacles of implementing HIT systems and possible solutions. These factors can be segmented into two main issues: (1) designing an incentive structure that rewards physicians for adoption and use of HIT systems and (2) eliminating the high investment costs of implementing and maintaining such systems.

28.3.2 Value-Based Payment Systems

As noted in FCC’s National Broadband Plan, “those who benefit most from use of these technologies are often not the same as those who shoulder the implementation costs.”⁷⁸⁹ Providers who pay for equipment and training are likely to lose money through HIT investments, while payers/patients extract the benefits.⁷⁹⁰ Currently, physicians are compensated by a volume-based system. The use of HIT systems will reduce admissions through electronic-prescribing, preventive care, non-visit-based care, and overall better management of patient conditions. Such a reduction in admissions will take away from visit-based care “that is the financial lifeblood of

⁷⁸⁷ Jha, et al., “Use of Electronic Health Records,” 1628.

⁷⁸⁸ Hospitals who adopted were less likely to cite four out of five of these as barriers (still cited physician resistance problems).

⁷⁸⁹ Federal Communications Commission, *National Broadband Plan*, Chapter 10, Health Care, 204.

⁷⁹⁰ Hillestad, et al., “Can Electronic Medical Record Systems Transform Health Care?” 1103–1117.

the practice.”⁷⁹¹ Such a payment system reduces the physician’s incentive to adopt HIT systems.

Thus, providing rewards and financial incentives (top two “contributing characteristics”) for adoption and use of HIT systems will reduce resistance by physicians and “clear-up” concerns about returns on investment (both significant “barriers to adoption”). However, “the fundamental solution to this dilemma is to change market incentives for health care providers to reward the delivery of higher-quality, more efficient care.”⁷⁹² The establishment of a value-based payment system that ties “payments to proven, measurable expenditure reductions and health improvements” is essential.⁷⁹³ However, the lack of large-scale HIT adoption cripples the ability to institute a value-based payment regime that would incentivize providers to adopt HIT systems. This is known as the “vicious cycle.” Therefore, providing reimbursements and financial rewards for HIT adoption is crucial in order to establish the framework for a robust HIT network. This foundation will support the construction of a value-based payment regime spurring further investment in HIT systems. This is known as the “virtuous cycle.”⁷⁹⁴

As part of the American Recovery and Reinvestment Act of 2009, the Health Information Technology for Economic and Clinical Health Act delegates \$19.2 billion to reward “meaningful use” of HIT systems with payments ranging from \$44, 000 to \$64,000 per physicians and up to \$11 million per hospital.⁷⁹⁵ Such funding programs will help accelerate adoption of HIT systems in order to establish value-based payment systems and spur the “virtuous cycle” further accelerating HIT adoption. However, simply providing financial incentives is not enough to induce the required wide-spread adoption of HIT systems necessary in implementing a new payment regime. The large investment costs in providing the necessary broadband infrastructure creates a hindrance to wide-spread HIT adoption. This is particularly a problem in rural regions with weak broadband infrastructures.

28.3.3 Rural Broadband Access

The capital costs required to invest in HIT systems in addition to the cost of maintaining such systems is a major concern for rural providers. While urban physicians benefit from economies-of-scale, existing HIT hardware, and broadband infrastructures, rural providers generally do not have access to such networks.⁷⁹⁶ Health providers in rural communities face additional

⁷⁹¹ Park and Basch, *Historic Opportunity*, 16.

⁷⁹² Park and Basch, *Historic Opportunity*, 2.

⁷⁹³ Federal Communications Commission, *National Broadband Plan*, Chapter 10, Health Care, 203.

⁷⁹⁴ Park and Basch, *Historic Opportunity*. “Research suggests that physicians react to market forces that affect earnings by changing the way they practice medicine” U.S. Department of Health and Human Services, *Physician Workforce*, 82.

⁷⁹⁵ Health Information Technology for Economic and Clinical Health (HITECH) Act; Federal Register Vol. 74 No. 79, April 2009, Rules and Regulations.

⁷⁹⁶ It is estimated that 29% of Rural Health Clinics are without Mass-Market Broadband. Mass-Market Broadband

challenges to HIT adoption due to a shortage in IT-trained employees, limited broadband connectivity, and insufficient access to financing.⁷⁹⁷ Therefore, in order to induce small rural providers to adopt HIT systems, funding programs have been implemented to reduce the financial burden of constructing the necessary broadband infrastructure, implementing and maintaining HIT systems, and subsidizing the necessary employee training in IT systems.

In 1997, the FCC created the Rural Health Care Program, funded through the Universal Service Fund. This is the most extensive rural funding program. It is broken up into three types of subsidies to public and non-profit health care providers. First, the program subsidizes the rates paid by rural providers to eliminate the urban- rural rate inequalities.⁷⁹⁸ Second, to “support advanced telecommunications and information services the program provides a 25% flat discount on monthly Internet access for rural health care providers and a 50% discount for health care providers in states that are entirely rural.”⁷⁹⁹ Lastly, in 2006 the program adopted the Rural Pilot Program that provides up to 85 percent of the infrastructure costs and all recurring capital and operation costs over the first five years. In total, FCC’s Rural Pilot Program offers \$417 million funds to an eligible 62 projects nationwide serving 6,000 health care facilities.⁸⁰⁰

Each subsidy plays an integral role in decreasing the “barriers to adoption” for rural providers. However, “less than 25% of the approximately 11,000 eligible institutions are participating in the program, and many are not acquiring connections capable of meeting their needs.”⁸⁰¹ Those who don’t participate claim either the subsidy is too low or the application process is too complex. Large gaps in broadband access suggests that reforms to the current program are needed. In particular, restriction on funding to for-profit entities may limit the wide-spread implementation of broadband networks and HIT systems. “In rural areas alone, for-profit eligibility restrictions exclude more than 70% of the 38,000 health care providers; many face the same disadvantages in securing broadband as the eligible providers.”⁸⁰²

The Rural Pilot Program, represents an important step in motivating rural broadband investment

are “small business” packages with at least 4 Mbps capacity. Bandwidth lower than 4Mbps constrains these providers “from achieving full adoption of video consultation, remote image diagnostic and Emergency Health (Medical) Record technology.” Federal Communications Commission, *National Broadband Plan*, Chapter 10, Health Care, 211.

⁷⁹⁷ National Advisory Committee on Rural Health and Human Services, *2006 Report to the Secretary*.

⁷⁹⁸ Rural providers face significant price inequalities compared to urban regions. Rural providers’ broadband prices average three times the price of urban benchmarks Federal Communications Commission, *National Broadband Plan*, Chapter 10, Health Care.

⁷⁹⁹ Federal Communications Commission, *National Broadband Plan*, Chapter 10, Health Care, 214.

⁸⁰⁰ Federal Communications Commission, *Rural Telemedicine Program Funds 16 More Broadband Telehealth Networks*.

⁸⁰¹ Federal Communications Commission, *National Broadband Plan*, Chapter 10, Health Care, 213.

⁸⁰² *Ibid.*, 214.

and extending HIT systems. This program connects rural communities and providers to “broadband backbone” networks by collaborating with existing urban networks and HIT systems offering costs savings through economies-of-scale in HIT infrastructure costs, telemedicine opportunities, existing EMR networks, and urban Regional Health Care Information Organizations (RHIOs).⁸⁰³ In the past two years the pilot program has funded more than 22 projects with funding support up to \$191.2 million. The success of Rural Pilot Program exemplifies the importance of eliminating “barriers of adoption” in rural regions in order to establish wide-spread HIT adoption.

28.4 Florida Health IT

In May 2004 the Florida Legislature passed the Affordable Health Care for Floridians Act, which authorized Florida’s Agency for Health Care Administration (AHCA) to develop a strategy to implement extensive Health Information Exchange (HIE) networks in Florida. The Florida Health Information Network (FHIN), as set out by AHCA, is a framework “to strengthen Florida’s health care system through the timely, secure and authorized exchange of patient health information among health care stakeholders.”⁸⁰⁴ The FHIN can be separated into two components: (1) establishment of Regional Health Information Organizations (RHIOs) and (2) construction of a statewide broadband infrastructure sufficient to support transfer of bandwidth-intensive information connecting RHIOs.⁸⁰⁵ In order to establish such a capital-intensive system, extensive state and federal funding programs have been implemented to support the construction of Florida’s HIE network.

During the past five years, FHIN grants and other state/federal funding programs worth \$5.5 million have assisted in starting-up ten RHIOs. When funding ended, nearly half of the proposed RHIOs were engaged in some degree of HIE (Tallahassee, Jacksonville, Pensacola, Tampa, and Orlando), while several more RHIO efforts are currently underway (Ocala, Sarasota, Melbourne, Miami, and Brevard).⁸⁰⁶ It has been estimated that 16 RHIOs are necessary to cover Florida’s population of 18 million, each with a start-up cost of \$3 million, with an estimated total cost of \$51 million.⁸⁰⁷ These RHIOs play a crucial role in implementing HIE networks and other HIT

⁸⁰³ An (RHIO) is an organization “that brings together health care stakeholders within a defined geographic area and governs health information exchange (HIE) among them for the purpose of improving health and care in that community.” With HIE being a subsystem within HIT systems and is “the electronic movement of health-related information among organizations according to nationally recognized standards.” Source: National Alliance for Health Information Technology HIT definitions.

⁸⁰⁴ Agency for Health Care Administration, *Florida Health Information Exchange*, 39.

⁸⁰⁵ Gionfriddo, “Florida’s Health Information Network.” FHIN is a virtual transportation system in which RHIOs create the “local roadway” system and statewide broadband infrastructure represent the “highways” connecting RHIOs who aggregate local information.

⁸⁰⁶ Agency for Health Care Administration, *Florida Health Information Exchange*.

⁸⁰⁷ Gionfriddo, “Florida’s Health Information Network.” However, RHIOs may exhibit economies-of-scale due to

systems. RHIOs allow local providers to “access pertinent health information and share data with other providers treating the same patient. The RHIO will be responsible for merging the data from providers at the local level.”⁸⁰⁸ If the patient leaves their local area, the state’s broadband infrastructure “kicks-in” by connecting local RHIOs, establishing interoperability statewide.⁸⁰⁹ However, due to inadequate funding, most RHIOs are in their early stages. Future funding projects are required to establish robust RHIOs supporting a comprehensive Florida Health Information Network.⁸¹⁰

In order to realize all the possible benefits of RHIOs and HIE systems, significant broadband infrastructure investments are necessary to establish statewide connectivity. Similar to other states, Florida encounters connectivity issues in rural regions. For example, only 68.4 percent of system-affiliated rural hospitals have access to local area networks compared to 89.7 percent of system-affiliated urban hospitals in Florida.⁸¹¹ Therefore, substantial investments in rural broadband infrastructure is necessary to eliminate this connectivity gap. There are several rural funding programs established by state and federal organizations that set out to connect rural communities to RHIO networks and Florida’s LambdaRail. In particular, in November 2007 the FCC awarded \$9.6 million from the Rural Pilot Program to the Big Bend RHIO and Florida’s AHCA to build a Health Information Network in the Florida Panhandle. This project set out to build a gigabit fiber optical network from the FLR interface points, connecting nine rural hospitals and establishing a broadband wireless network providing broadband access to non-profit clinics in rural communities (see Figure 3).⁸¹² Once the project is complete, the nine rural hospitals can connect to the Big Bend RHIO providing them access to the Tallahassee Private Medical Area Network (pMAN). Also, the broadband wireless network installed in each county provides connectivity to other health facilities and clinics in the region expanding broadband availability and connectivity to HIT systems.⁸¹³ Such rural funding programs will establish broadband infrastructure in rural regions to modernize health care technology and lead to overall economic growth.⁸¹⁴

their large fixed (start-up) costs. Thus, fewer more geographically expansive RHIOs may be optimal.

⁸⁰⁸ Gionfriddo, “Florida’s Health Information Network,” 2.

⁸⁰⁹ More broadly, AHCA requires Florida’s RHIOs to adhere to National Health Information Network (NHIN) standards. This network allows Florida to exchange data on a national level. This is especially beneficial in Florida due to the amount of tourism and temporary residents during the winter Agency for Health Care Administration, *Florida Health Information Exchange*.

⁸¹⁰ Agency for Health Care Administration, *Florida Health Information Exchange*.

⁸¹¹ Menachemi, et al., “Information Technologies in Florida’s Rural Hospitals,” 263-68.

⁸¹² Recall, for-profit entities cannot receive funding from the Rural Pilot Program, but they are able to access this infrastructure for a fee dependent upon their usage.

⁸¹³ Connecting Florida’s Rural Health Care Providers to a Broadband Information Network; Application for Rural Health Care Support Mechanism. WC Docket No. 02-60.

⁸¹⁴ In a recent study on analyzing the economic benefits of broadband network investment. Every dollar invested in



Figure 3. Big Bend RHIO Rural Pilot Program Hospitals

Source: Agency for Health Care Administration, 2010

Establishing connections from rural regions to urban RHIOs will allow Florida to construct a statewide Health Information Network. The Florida Health Information Network (FHIN) will eliminate the balkanization of the health care industry in Florida and move towards a nationwide information network that supports the implementation of wide-spread HIT systems. Such systems provide Florida with a reduction in health care costs, improved life-saving care, and better emergency response capacity to events such as hurricanes and disease outbreaks. However, establishing operational RHIOs and sufficient broadband infrastructure involves high capital costs. Therefore, it is essential that Florida organizations and federal authorities continue to fund such investments in order to establish an extensive Health Information Network.⁸¹⁵

28.5 Conclusion

HIT has the capacity to greatly improve the health care industry. However, the barriers to wide-spread adoption must be eliminated to extract all of the possible gains. Hence, it is up to local, state, and federal funding programs to establish a robust broadband infrastructure, assist in training employees in IT systems, and introduce a new payment regime to incentivize providers

broadband, the economic activity due to the additional connectivity generates three dollars. The county under study “experienced 128% growth over its peers since the municipal broadband network was built.” Ford and Koutsky, “Broadband and Economic Development,” 216–229.

⁸¹⁵ Florida’s AHCA received up to \$20.7 million in funding through the Cooperative Agreement Program as part of the American Recovery and Reinvestment Act of 2009. This funding is in the process of choosing a vendor to design and construct further Health Information Networks Agency for Health Care Administration, *Florida Health Information Exchange*.

to implement such systems.

The benefits from the resulting infrastructure and HIT investments are not limited to improved day-to-day health care services. Rather, robust broadband networks that support wide-spread HIT systems can play a crucial role in emergency situations. In particular, it is essential that the state of Florida establishes wide-spread HIT systems and broadband infrastructure in order to have the capacity to respond to an unexpected emergency event such as a hurricane. For instance, during Hurricane Katrina, “a fundamental communications disaster unfolded - knocking out the 9-1-1 network; cutting off hospital communications; highlighting an inability of emergency medical workers to communicate with each other.”⁸¹⁶ Such an event highlighted the need for improved health communications. HIT systems reveal endless opportunities for health care improvements and innovations, but collaboration between government authorities is essential in order to eliminate the barriers to wide-spread adoption.

⁸¹⁶ Federal Communications Commission, *Joint Advisory Committee on Communications*, 6.

29 Appendix VII: Technical Comparison of State Networks

Figure 29-1. Technical Comparison of State Networks

Index	Network	Illinois	Illinois (Other)	New York	New York (Other)	Ohio	Ohio (Other)	Pennsylvania	Pennsylvania (Other)
1	Name	ICN	IWIN,IVN	NYeNet	NYSERNET, Statewide Interoperable Network	OARnet	MARCS, OPLIN, OAKS	Net COPA	Penn's TNS, PA-STARNET, PAIUNet, PennREN
1.1	Administering agency/ Operated by	Bureau of communication and Computer Services (BCCS)	BCCS(IWIN)	Office of Technology		Office of Information Technology Department of administrative services		Office of Administration information Technology	Telecommunications and Networking Services (Penn's TNS)
2	Description	A Telecommunications Backbone	Wireless and public safety network (IWIN)	A unified, statewide communications system with a bridge (OneNetNYS)	Education and Research Backbone Network(NYSERNET) Public Safety network(Statewide Interoperable Network)	A merger of Ohio.gov and OarNet,the higher education network	Public Safety network(MARCS), Library network(OPLIN)	Fiber Optic Backbone Network	University Integrated Backbone (Penn's TNS) ,Public Safety(PA-STARNET),library and school network(PAIUNet), education network (PennREN)
2.1	Topology								

Index		Network	Illinois	Illinois (Other)	New York	New York (Other)	Ohio	Ohio (Other)	Pennsylvania	Pennsylvania (Other)
	2.11	Geography	State (Schools, libraries, local government, state)	State (Federal, State, County and local government)	Connecting State and Local Governments	State, Universities	State, Local governments, Local Rings and K-12	State	State	State, Local, Education
	2.12	Architecture								
	2.121	Port	port DS1&DS3, Ethernet	Ethernet	port DS1(T1)&DS3, Ethernet	100M-10G(NYSERN ET) Ethernet	port DS1(T1)&DS3, Ethernet	800MHZ wireless(MARCS)	N/A	
	2.122	Access								
	2.1221	Frame Relay	No		Yes		Yes		Yes	
	2.1222	Ethernet	Yes		Yes	Yes	Yes	Yes	Yes	

Strategic Planning for Florida Governmental Broadband Capabilities
 Volume 2—Appendix VII: Technical Comparison of State Networks

Index				Network	Illinois	Illinois (Other)	New York	New York (Other)	Ohio	Ohio (Other)	Pennsylvania	Pennsylvania (Other)
			2.1223	ATM	Yes		No		Yes		Yes	
			2.1224	DSL	N/A	No	No	No	No	No	Yes	Yes
			2.123	Attributes	N/A	N/A	Target level 99.999% availability and actual performance in the prior year was 99.97 percent	N/A	99.99% availability		99.999% reliability and availability	
			2.124	Node interconnection	a combination of redundant OC-48 (2.5 Gbps) and OC-12 (600 Mbps)	N/A	N/A	unknown	N/A	N/A	N/A	
			2.125	Speed/Capacity	OC-48 (2.5 Gbps) & OC-12 (600 Mbps) & Peering (1-10Gb)		N/A		OC-192 (SONET) transport or 10 gigabit speed		10 Gbps	10 Gbps up to 40 Gbps 1Gbps for Wavelength
			2.126	Technology	Ethernet, MPLS and IP over optical Fiber		Ethernet, MPLS and IP over fiber and DWDM	Fiber Optic, DWDM (NYSERNet)	Ethernet, MPLS and IP over fiber and DWDM		Ethernet, MPLS and IP over fiber and DWDM	MPLS and DWDM

Strategic Planning for Florida Governmental Broadband Capabilities
 Volume 2—Appendix VII: Technical Comparison of State Networks

Index			Network	Illinois	Illinois (Other)	New York	New York (Other)	Ohio	Ohio (Other)	Pennsylvania	Pennsylvania (Other)
		2.127	SLAs	Yes	Yes	Yes	Yes	Yes, The standards are specified in individual contracts.		Yes	
		2.1271	Issue Resolution Standard	N/A		4 hours but there is a provision for more flexibility depending on the magnitude of the problem		4 hours		4 hours of an outage, but the maximum time is 24 hours	
		2.1272	NMS/NOC	Yes		Yes		Yes		Yes	
		2.1273	CPE	Discounted pricing on Cisco equipment through AT&T		Customer provided		Customer provided		Customer provided	
		2.1274.	QOS	Yes		Yes		Yes		Yes	
		2.1275	Support	24x7x365		24*7*365		24*7*365		24*7*365	24*7*365

Strategic Planning for Florida Governmental Broadband Capabilities
 Volume 2—Appendix VII: Technical Comparison of State Networks

Index	Network	Illinois	Illinois (Other)	New York	New York (Other)	Ohio	Ohio (Other)	Pennsylvania	Pennsylvania (Other)
3	Business Model	Centralized management/operations		Decentralized management	Research education network	Centralized management	Centralized management/operations	Centralized management	Consolidation of IT functions has been underway since 2004.
3.1	Purpose (Markets Served)	High speed access to data,video,audio in school, libraries, museum, local government and state	For wireless user(IWIN)	To serve the current and future needs of New York’s state and local governments.	To satisfy needs common to the institutions comprising New York State’s Research and education community(NY SERNET)	To provide Internet connectivity or redundancy to institutions already connected to the local rings	Public Safety	To provide scalable high-speed bandwidth that can meet both current and future business requirements.	Research education,K-12,Library
3.11	State Agencies	Yes	Yes	Yes	No(NYSERNET)	Yes	Yes	Yes	Yes
3.12	Local Agencies	Yes	Yes(IWIN) No(IVN)	Yes	No(NYSERNET)	Yes	Yes	Yes	No
3.13	Schools	Yes	No	No	Yes(with BOCES For NYSERNET)	Yes	No	No	No
3.14	Libraries	Yes	No	No	N/A	Yes	No	No	Yes

Index	Network	Illinois	Illinois (Other)	New York	New York (Other)	Ohio	Ohio (Other)	Pennsylvania	Pennsylvania (Other)
3.15	Universities	Yes	No	No	Yes(NYSERNET)	Yes	No	No	Yes
3.16	Private Sector	Yes	No	No	N/A(NYSERNET)	N/A		No	
3.2	Source - Network								
3.21	Outsourced, In-sourced, or Hybrid? Just Network	Out-sourced network but plan to state owned network	In-sourced	In-sourced but there is some private sector provisioning of services	In-sourced	In-sourced	In-sourced	Mixed The Commonwealth has replaced leased data circuits with its own fiber optic connectivity in the Harrisburg capitol complex. That state-owned facility is managed under the central contract through which network services are provided to state agencies and local units that choose to use the contract. However, the main network is currently provided via a	Hybrid

Index	Network	Illinois	Illinois (Other)	New York	New York (Other)	Ohio	Ohio (Other)	Pennsylvania	Pennsylvania (Other)
								contract with Level3 that will expire in 2011.	
3.22	Provider or Partner?	AT&T	Verizon Wireless and Motorola(IWIN)	OneNetNYS	N/A	AT&T,TW Telecom, Qwest	N/A	TelCove until 2011, Verizon	Variety of commercial provider
3.23	Reasoning	Economies of Scale	Technology and Redundancy	Economies of Scale and serve customer demand	Variety provider	Economies of Scale and serve customer demand	Multiple supply and Redundancy	Economies of Scale and serve customer demand	Technology and geography
4	Funding	A mix of appropriations and cost recovery revenue		Fee collected from agencies	Federal Grant(Statewide Interoperable Network)	Fee collected from agencies and State general fund appropriation for 2008-2009	Annual operating budget(MARCS)	State General Fund and Fee collected from agencies	State General Fund and the Motor License Fund(PA-STARNET)
4.1	Federal Grant	Yes	No	N/A	Yes(Statewide Interoperable Network)	Yes	No	No	Yes
4.2	Tax	No		No		No		No	

Strategic Planning for Florida Governmental Broadband Capabilities
 Volume 2—Appendix VII: Technical Comparison of State Networks

Index	Network	Illinois	Illinois (Other)	New York	New York (Other)	Ohio	Ohio (Other)	Pennsylvania	Pennsylvania (Other)
4.3	State Budget Line Item	Yes		Yes	No	Yes	Yes(MARCS)	Yes and get some funds from Commonwealth's Productivity Bank	Yes(PA-STARNET)
4.4	Sales Revenues	Yes		Yes		Yes		Yes	Yes
5	Analysis								
5.1	Pricing	AT&T and ICN		NYenet,OneNet NYS		OARnet,AT&T,TW Telecom, Qwest		TelCove, Verizon	
5.11	Levels of Service, Pricing	“Cost Recovery” mechanism Services, in addition to primary constituents paid for by the appropriation, are charged to the participant at a rate based on actual costs that are determined annually		Connectivity and NOC included. Ethernet: Its Pricing makes a distinction between capital district and outside the district. Frame relay: Beginning with \$195 per month for 56K to \$1405 for T1 Point-to-point purchases of circuits cost \$650		Ohio state agencies pay a connection fee based on bandwidth requirement and pay for individual circuits which can purchased through state's contract with AT&T at discounted rates. Pricing is on a case by case basis		Main contract The commonwealth is transitioning voice, data and network security services from the current provider (Level 3) to Verizon. The current contract with Level 3 expires on	Wireless Access (PA-starnet)

Strategic Planning for Florida Governmental Broadband Capabilities
 Volume 2—Appendix VII: Technical Comparison of State Networks

Index	Network	Illinois	Illinois (Other)	New York	New York (Other)	Ohio	Ohio (Other)	Pennsylvania	Pennsylvania (Other)
					per circuit but a reverse auction cost \$600. Internet connectivity: pricing is set by port speed E-port: 2Mbps-1Gbps \$250-1200 per month		based on speed for local access and port. (\$806 per port Mb monthly) Management fee of 5 percent is charged by AT&T, TW telecom. Ethernet access, SONET (1.5 Mbps-1Gbps)	February 18, 2011. Ethernet access:	

30 Appendix VIII: Comparison States' Pricing Network Service Information

We include in this section price data from other states. However, we note that this price data cannot be legitimately compared with prices in Florida without adjusting for differences in service quality, demographics, costs, and a host of technical issues. Because of the danger of misinterpreting price data taken out of context, we recommend that careful and rigorous benchmark comparisons be performed on a regular basis so that policymakers can assess the performance of the Florida approach to broadband procurement.

30.1 Illinois

Table 30-1. Cost Recovery Data FY 2008-2009

Cost Recovery Data FY 2008 – 2009

Mb	Current Total	Current Per/Mb	Mb	Current Total	Current Per/Mb	Mb	Current Total	Current Per/Mb	Mb	Current Total	Current Per/Mb
1	\$170.00	\$170.00	51	\$5,279.95	\$103.53	101	\$8,763.06	\$86.76	151	\$11,611.23	\$76.90
2	\$340.00	\$170.00	52	\$5,358.70	\$103.05	102	\$8,825.17	\$86.52	152	\$11,663.51	\$76.73
3	\$510.00	\$170.00	53	\$5,436.98	\$102.58	103	\$8,887.03	\$86.28	153	\$11,715.63	\$76.57
4	\$663.94	\$165.99	54	\$5,514.80	\$102.13	104	\$8,948.66	\$86.04	154	\$11,767.58	\$76.41
5	\$802.55	\$160.51	55	\$5,592.16	\$101.68	105	\$9,010.05	\$85.81	155	\$11,819.38	\$76.25
6	\$936.22	\$156.04	56	\$5,669.08	\$101.23	106	\$9,071.21	\$85.58	156	\$11,871.02	\$76.10
7	\$1,065.78	\$152.25	57	\$5,745.56	\$100.80	107	\$9,132.13	\$85.35	157	\$11,922.50	\$75.94
8	\$1,191.83	\$148.98	58	\$5,821.61	\$100.37	108	\$9,192.83	\$85.12	158	\$11,973.83	\$75.78
9	\$1,314.80	\$146.09	59	\$5,897.24	\$99.95	109	\$9,253.30	\$84.89	159	\$12,025.00	\$75.63
10	\$1,435.04	\$143.50	60	\$5,972.45	\$99.54	110	\$9,313.54	\$84.67	160	\$12,076.01	\$75.48
11	\$1,552.82	\$141.17	61	\$6,047.25	\$99.14	111	\$9,373.57	\$84.45	161	\$12,126.87	\$75.32
12	\$1,668.36	\$139.03	62	\$6,121.65	\$98.74	112	\$9,433.37	\$84.23	162	\$12,177.58	\$75.17
13	\$1,781.86	\$137.07	63	\$6,195.65	\$98.34	113	\$9,492.95	\$84.01	163	\$12,228.14	\$75.02
14	\$1,893.47	\$135.25	64	\$6,269.26	\$97.96	114	\$9,552.31	\$83.79	164	\$12,278.55	\$74.87
15	\$2,003.33	\$133.56	65	\$6,342.50	\$97.58	115	\$9,611.46	\$83.58	165	\$12,328.81	\$74.72
16	\$2,111.54	\$131.97	66	\$6,415.35	\$97.20	116	\$9,670.40	\$83.37	166	\$12,378.92	\$74.57
17	\$2,218.23	\$130.48	67	\$6,487.83	\$96.83	117	\$9,729.12	\$83.15	167	\$12,428.88	\$74.42
18	\$2,323.47	\$129.08	68	\$6,559.94	\$96.47	118	\$9,787.63	\$82.95	168	\$12,478.70	\$74.28
19	\$2,427.34	\$127.75	69	\$6,631.70	\$96.11	119	\$9,845.94	\$82.74	169	\$12,528.36	\$74.13
20	\$2,529.93	\$126.50	70	\$6,703.10	\$95.76	120	\$9,904.04	\$82.53	170	\$12,577.89	\$73.99
21	\$2,631.29	\$125.30	71	\$6,774.15	\$95.41	121	\$9,961.94	\$82.33	171	\$12,627.27	\$73.84
22	\$2,731.47	\$124.16	72	\$6,844.85	\$95.07	122	\$10,019.63	\$82.13	172	\$12,676.50	\$73.70
23	\$2,830.55	\$123.07	73	\$6,915.21	\$94.73	123	\$10,077.12	\$81.93	173	\$12,725.60	\$73.56
24	\$2,928.55	\$122.02	74	\$6,985.23	\$94.40	124	\$10,134.41	\$81.73	174	\$12,774.55	\$73.42
25	\$3,025.53	\$121.02	75	\$7,054.93	\$94.07	125	\$10,191.51	\$81.53	175	\$12,823.36	\$73.28
26	\$3,121.54	\$120.06	76	\$7,124.30	\$93.74	126	\$10,248.40	\$81.34	176	\$12,872.03	\$73.14
27	\$3,216.59	\$119.13	77	\$7,193.34	\$93.42	127	\$10,305.11	\$81.14	177	\$12,920.56	\$73.00
28	\$3,310.74	\$118.24	78	\$7,262.06	\$93.10	128	\$10,361.62	\$80.95	178	\$12,968.95	\$72.86
29	\$3,404.01	\$117.38	79	\$7,330.48	\$92.79	129	\$10,417.94	\$80.76	179	\$13,017.21	\$72.72
30	\$3,496.44	\$116.55	80	\$7,398.58	\$92.48	130	\$10,474.06	\$80.57	180	\$13,065.32	\$72.59
31	\$3,588.04	\$115.74	81	\$7,466.37	\$92.18	131	\$10,530.00	\$80.38	181	\$13,113.31	\$72.45
32	\$3,678.86	\$114.96	82	\$7,533.86	\$91.88	132	\$10,585.76	\$80.20	182	\$13,161.15	\$72.31
33	\$3,768.91	\$114.21	83	\$7,601.05	\$91.58	133	\$10,641.32	\$80.01	183	\$13,208.86	\$72.18
34	\$3,858.21	\$113.48	84	\$7,667.95	\$91.29	134	\$10,696.70	\$79.83	184	\$13,256.44	\$72.05
35	\$3,946.80	\$112.77	85	\$7,734.55	\$90.99	135	\$10,751.90	\$79.64	185	\$13,303.88	\$71.91
36	\$4,034.68	\$112.07	86	\$7,800.86	\$90.71	136	\$10,806.92	\$79.46	186	\$13,351.19	\$71.78
37	\$4,121.88	\$111.40	87	\$7,866.89	\$90.42	137	\$10,861.76	\$79.28	187	\$13,398.37	\$71.65
38	\$4,208.42	\$110.75	88	\$7,932.64	\$90.14	138	\$10,916.41	\$79.10	188	\$13,445.42	\$71.52
39	\$4,294.31	\$110.11	89	\$7,998.11	\$89.87	139	\$10,970.89	\$78.93	189	\$13,492.33	\$71.39
40	\$4,379.57	\$109.49	90	\$8,063.30	\$89.59	140	\$11,025.20	\$78.75	190	\$13,539.12	\$71.26
41	\$4,464.22	\$108.88	91	\$8,128.22	\$89.32	141	\$11,079.33	\$78.58	191	\$13,585.78	\$71.13
42	\$4,548.27	\$108.29	92	\$8,192.87	\$89.05	142	\$11,133.28	\$78.40	192	\$13,632.31	\$71.00
43	\$4,631.74	\$107.71	93	\$8,257.26	\$88.79	143	\$11,187.06	\$78.23	193	\$13,678.71	\$70.87
44	\$4,714.63	\$107.15	94	\$8,321.38	\$88.53	144	\$11,240.67	\$78.06	194	\$13,724.99	\$70.75
45	\$4,796.97	\$106.60	95	\$8,385.24	\$88.27	145	\$11,294.11	\$77.89	195	\$13,771.13	\$70.62
46	\$4,878.76	\$106.06	96	\$8,448.84	\$88.01	146	\$11,347.38	\$77.72	196	\$13,817.16	\$70.50
47	\$4,960.02	\$105.53	97	\$8,512.18	\$87.75	147	\$11,400.48	\$77.55	197	\$13,863.05	\$70.37
48	\$5,040.76	\$105.02	98	\$8,575.28	\$87.50	148	\$11,453.42	\$77.39	198	\$13,908.83	\$70.25
49	\$5,120.99	\$104.51	99	\$8,638.12	\$87.25	149	\$11,506.18	\$77.22	199	\$13,954.47	\$70.12
50	\$5,200.71	\$104.01	100	\$8,700.71	\$87.01	150	\$11,558.79	\$77.06	200	\$14,000.00	\$70.00

Cost Recovery Data FY 2008 – 2009

Baseline Modifications Current Baseline

FTE Count	Baseline Current
1 – 999	8
1000 – 1999	8
2000 – 2999	8
3000 – 3999	8
4000 – 4999	10
5000 – 5999	12
6000 – 6999	14
7000 – 7999	16
8000 – 8999	18
9000 – 9999	20
10000 – 10999	22
11000 – 11999	24
12000 – 12999	26
13000 – 13999	28
14000 – 14999	30
15000 – 15999	32
16000 – 16999	34
17000 – 17999	36
18000 – 18999	38
19000 – 19999	40
20000 – 20999	42
21000 – 21999	44
22000 - +	45

30.2 New York

Table 30-2. Summary of Rates for IT Shared Services

APPENDIX B: LISTING OF CIO/OFT IT SHARED SERVICES RATES PER COST UNIT

Table 11: Summary of Rates for IT Shared Services		
<i>(Note: *Additional one time charges or credits may be applicable where indicated with an asterisk.) (Current rates are available at www.cio.ny.gov)</i>		
CIO/OFT IT Shared Service	FY 10-11 Monthly Rate	Cost Unit or Additional Information
Customer Care Center Services		
Security Support Tickets	\$15.29	Per Incident
Desktop Software Support	\$23.91	Per Incident
Application Support Tickets	\$26.37	Per Incident
Hardware Support/Dispatch Tickets	\$30.07	Per Incident
NYS Directory Services		
Authentication to Web Applications	\$0.00	No Charge
Authorization for Web Applications	\$0.00	No Charge
Delegated Administration	\$0.00	No Charge
Self-Care	\$0.00	No Charge
Enterprise 2.0 Web Services		
Website Design and Hosting	\$Varies	Per server and estimated bandwidth
Website Content Management	\$Varies	Per size of site
Enterprise Data Center Operations and Services		
Mainframe - Unisys 2200	\$0.000534	Per Standard Processing Unit (SUP)
Mainframe - Unisys A	\$0.020650	Per CPU Second
Mainframe - IBM	\$0.0539	Per CPU Second
on - demand	\$2,230.89	Monthly Administration/Maintenance Charge
IBM Mainframe DR Set-up	\$10,556.65	New Customer Initial Setup Charge
IBM Mainframe DR Test	\$30,985.15	Not Applicable FY 2010-11 (Included in CPU Charge)
Print	\$0.03495	Per Image (One printed side of page)
Manual Tape	\$9.6484	Per Tape Mount
Robotic Tape	\$0.6683	Per Tape Mount
Tape Ejection	\$5.8164	Per Tape
Data Storage - Tier 1	\$1.9126	Per Gigabyte (GB)
Data Storage - Tier 3C	\$2.1659	Per Gigabyte (GB)
Data Storage - Tier 3I	\$1.0062	Per Gigabyte (GB)
IBM storage Staffing Only	\$0.6143	Per Gigabyte (GB)
Data Storage -EMC	\$3.70	Per Gigabyte (GB)
Enterprise Shared SQL (new service in 2010/11)	\$324.93	Per Instance
Open Systems (Servers)	See Turnkey	Per Server
Open Systems Field Servers	\$139.72	Per Server
Open Systems Backup	\$1.04	Per Gigabyte (GB)
Open System backup Staff Only	\$0.38	Per Gigabyte (GB)
Reverse Proxy	\$194.69	Per URL
Avamar Backup for Field servers	\$2.71	Per GB of Protected Data
Rack Install	\$5,250.00	Per Rack
ITCAM for WAS	\$222.69	Per JVM (JAVA Virtual Machine)
ITCAM for Transactions (new service in 2010/11)	\$187.29	Per Collector
Server Install	\$350.00	Per Server

Table 11: Summary of Rates for IT Shared Services

(Note: *Additional one time charges or credits may be applicable where indicated with an asterisk.) (Current rates are available at www.cio.ny.gov)

CIO/OFT IT Shared Service	FY 10-11 Monthly Rate	Cost Unit or Additional Information
CD Writers	\$13.56	Per CD
Turnkey Server- Silver	\$202.72	Per Server
Turnkey Server - Gold	\$309.70	Per Server
Turnkey Server - Platinum	\$411.57	Per Server
NYSeMail Services		
NYSeMail Mailbox	\$5.95	Per User
Additional Storage	\$1.00	Per Additional 100MB
NYSeMail Blackberry	\$10.20	Per Device
Customer Managed Network Solutions		
Network Operating System (NOS) Authentication	\$2.75	Per User
NOS File and Print Central	\$5.24	Per Gigabyte
NOS File and Print Remote	\$294.22	Per Device
Internet Access	\$2.56	Per User
Workstation	\$6.78	Per Device
Layer 2 Devices per 24-ports	\$96.70	Per Device
Small/Medium Layer 3 Devices	\$194.47	Per Device
Large Layer 3 Devices	\$2,819.87	Per Device
Secure Individual Remote Access (SIRA)	\$3.59	Per Device
SharePoint Collaboration Tool Hosting	\$1.65	Per Device
NYeNet Services		
ePort		Per Circuit. See www.cio.ny.gov/Services/Networking/index.htm
Low Speed - Frame Relay	Varies	
Low Speed - Point-to-Point T1	Varies	
High Speed - Ethernet	Varies	
iPort		
Internet Access via Ethernet	Varies	
Domain Name Services (DNS)		No Charge for ny.gov addresses
Network Operations Center (NOC)	\$0.00	No Charge - Included with NYeNet Connection
Technology Academy		
Empire Knowledgebank		Annually Per User License (Effective 1/1/10-12/31/10)*
Basic Course Library	\$15.96	
Books 24x7 Full Library	\$43.25	
Books 24x7 Business & Desktop Library	\$34.95	
Red Vector Library	\$359.00	
Care2Learn Library	\$55.00	
Mainframe Library	\$795.00	
Environment, Safety, & Health Library	\$30.90	
Compliance Library License	\$12.35	Annually Per User License (Effective 1/1/10-12/31/10)* \$5.00 when bundled with basic course library License; Mid-term Pricing Available
eLearnNY	\$0.00	No Charge -Customer Care Center charges do apply for password reset calls received.

Table 11: Summary of Rates for IT Shared Services

(Note: *Additional one time charges or credits may be applicable where indicated with an asterisk.) (Current rates are available at www.cio.ny.gov)

CIO/OFT IT Shared Service	FY 10-11 Monthly Rate	Cost Unit or Additional Information
Computer Classrooms Usage	\$0.00	No Charge
Training Coordination Services	\$0.00	No Charge
Telecommunications Services		
Labor - Avaya Dedicated Technician	\$115.93	Per Hour
Labor - AVAYA Switch Tech	\$125.20	Per Hour
Labor - Fronrunner Tech	\$91.67	Per Hour
Labor - RONCO Technician	<i>Labor rates per hour vary by Location. For individual rates visit: www.cio.ny.gov/telecom/rates.cfm</i>	
Labor AVAYA Overtime Switch Tech	\$187.80	Per Hour
Labor AVAYA Overtime Dedicated Tech	\$173.89	Per Hour
Verizon Line Installation Charge (Analog or Digital)	\$50.05	Per Hour
Call Center Agent - Per group of 10	\$2.20	Per Each Group
Call Center Vector	\$460.00	Per Vector
Call Center Link Carrier Verizon CKT Charge	\$358.18	Per Circuit
Call Center ACD Agent Login Number	\$4.00*	\$15 Per Number
Buffalo Call Center ACD Agent Login Number	\$4.00*	\$81 Per Number
CAPNET Call Center ACD Agent Login Number	\$4.00*	\$15.00 Per Number
Call Center ACD Announcement	\$46.00*	\$250 Per Announcement
Call Center ACD Skill	\$75.00*	\$250 Per Skill
Call Center ACD Vector Change to Add, Modify or Delete	\$50.00	Per Vector
Call Center CENTRE VU Supervisor License	\$30.00	\$300 Per License
T1 Full AT&T	\$314.47	\$592.57 Per T1
T1 Full CAPNET-Multiple Uses-Line Side Transport	\$504.35	Per T1
Cable TV Service	Varies	\$15.25 to 29.90 per user based on service (Analog, HDTV, Digital, DVR, etc). See www.cio.ny.gov/telecom/rates.cfm
Line Charge Extension, Physical Port Not Required	\$2.00	Per Device - All Locations
Line Charge Extension, Physical Port Required	\$17.00	Per device - All PBX Locations Except CAPNET
Line Charge Extension, Physical Port Required	\$18.00	Per Device - METRONET
Line Charge Extension, Physical Port Require	\$15.00	Per Device - CAPNET
Voice Mail 5 MIN - MAC Labor or as Vendor Invoiced	\$2.75	or more per user, based on service selected and location. For OCC Per User visit: www.cio.ny.gov/telecom/rates.cfm
Voice Mail 15 Minute Mailbox	\$3.25	\$37.26 OCC Per User for Binghamton \$35.00 OCC Per User for all other locations
Voice Mail 20 MIN COS 5	\$3.82	\$ 25.00 OCC Per User – All Locations
Voice Mail 30 Minute Mailbox	\$4.00	\$37.26 OCC Per User – Binghamton \$35.00 OCC Per User for all other locations
Voice Mail 33 MIN COS 4	\$5.85	\$25.00 OCC Per User - CAPNET
Voice Mail – All Additional Offerings	For monthly recurring and OCC charges per user, visit www.cio.ny.gov/telecom/rates.cfm	
Video Teleconferencing	\$50.00	Per Hour, Per Site
Station and other telephone equipment	For monthly recurring and OCC charges, visit www.cio.ny.gov/telecom/rates.cfm	
Visit www.cio.ny.gov/telecom/rates.cfm for additional information. Rates are updated annually.		

31 Bibliography

2009 Local Broadband Inventory Survey Conducted by the Department of Management Services.

2010 Local Broadband Inventory Survey Conducted by Magellan Advisors, LLC.

Agency for Enterprise Information Technology, *2010 Enterprise Information Technology Services Strategic Plan*, October 1, 2010, accessed January 25, 2011, <https://aeit.myflorida.com/sites/default/files/files/Enterprise%20Services%20Strategic%20Plan.pdf>.

Agency for Enterprise Information Technology, *2010 Enterprise Information Technology Services Strategic Plan*, “A Message from Florida’s CIO.”

Agency for Enterprise Information Technology, “Data Center Consolidation,” <https://aeit.myflorida.com/datacenterconsolidation>, Accessed September 30, 2009.

Agency for Health Care Administration, “Florida Health Information Exchange (HIE) Infrastructure,” Solicitation Number: AHCA ITN 002-10/11, July 15, 2010, accessed January 26, 2011, http://myflorida.com/apps/vbs/vbs_www.ad.view_ad?advertisement_key_num=88737.

Agency for Health Care Administration, Bid/Proposal, *Florida Health Information Exchange (HIE) Infrastructure*, Solicitation Number: AHCA ITN 002-10/11, September 2010, http://www.fha.org/acrobat/AHCA_Advertisement.pdf.

Agency for Health Care Administration, *State Health Information Exchange Cooperative Agreement Program*, accessed November 30, 2010, <http://www.fhin.net/FHIN/StateHealthInformationExchange/CombinedApplication.pdf>.

Amendment 5 to MyFloridaNet Contract dated 9/18/06 (the “Contract”) (ITN No.: 14-973-800-R).

AT&T Inc., *2009 Annual Report*, accessed February 22, 2011, http://www.att.com/Common/about_us/annual_report/pdfs/ATT2009_Full.pdf.

- Bischoff, Glenn, "Florida County Makes Transition to NG 911," *Urgent Communication*, October 21, 2010, <http://urgentcomm.com/psap/news/charlotte-county-ng911-transition-20101021/>.
- Bloomberg, Database, T US <Equity> <Go>, "WACC Analysis," accessed November 8, 2010, Bloomberg LP, <http://businesslibrary.uflib.ufl.edu/bloomberg>.
- Bloomberg, "Market Data," accessed December 19, 2010, <http://www.bloomberg.com/markets/rates-bonds/government-bonds/us/>.
- Boards of Cooperative Educational Services, "BOCES of New York State," accessed September 22, 2010, <http://www.boces.org/wps/portal/BOCESofNYS>.
- Brennan, Charles, "Pennsylvania Statewide Radio Network: PA-STARNet Project Update" presented January 29, 2009, accessed September 25, 2010, http://www.portal.state.pa.us/portal/server.pt?open=space&name=Dir&psname=SearchResult&psid=5&cached=true&in_hi_userid=2&control=OpenSubFolder&subfolderID=146678&DirMode=1.
- Brown, David, "Health Information Technology," University of Florida, Department of Economics, Public Utility Research Center Working Paper, 2010.
- Casey, Robert P. Jr., Pennsylvania Auditor General, *A Special Audit of the Telecommunications Services Contract Between the Governor's Office of Administration and Adelphia Business Solutions of Pennsylvania, Inc., September 23, 1998 through October 4, 2002*, December 20, 2004, accessed August 21, 2010, <http://www.auditor.gen.state.pa.us/archives/StateAgencies/Departmental/Adelphia.pdf>.
- Catalanello, Rebecca, "Florida High School Ditches Textbooks for E-readers," *The Bismarck Tribune*, June 7, 2010, http://www.bismarcktribune.com/lifestyles/fashion-and-style/article_6d9ec60c-6ebd-11df-93a0-001cc4c002e0.htm.
- Cavanaugh, John, and Jeffery Kuhns, "KINBER/PennREN Overview," presentations to the Pennsylvania Stimulus Oversight Commission, June 17, 2010, accessed February 2, 2011, http://www.pasenatepolicy.com/PDF_Files/KINBER.pdf.
- Center for Disease Control, "Chronic Diseases and Health Promotion," accessed 2008, last updated December 2009, <http://www.cdc.gov/chronicdisease/overview/index.htm>.

Center for Information Technology Leadership, *National Health Expenditure Projections 2009-2019*, 2009.

Cisco Systems, "OARnet Builds Statewide Optical DWDM Network to Meet Exploding Bandwidth Demand of Universities," accessed September 23, 2010,
http://www.cisco.com/en/US/prod/collateral/optical/ps5724/ps2006/prod_case_study0900aecd80278c47.html.

Cisco, *Cisco Visual Networking Index: Forecast and Methodology, 2009-2014*, June 2, 2010,
http://www.cisco.com/en/US/solutions/collateral/ns341/ns525/ns537/ns705/ns827/white_paper_c11-481360_ns827_Networking_Solutions_White_Paper.html.

Clark, Don, "Take Two Digital Pills and Call Me in the Morning," *Wall Street Journal*, August 4, 2009.

Commonwealth of Pennsylvania, "Telecommunications Managed Services Update," presented November 17, 2009, accessed online September 15, 2010,
http://www.portal.state.pa.us/portal/server.pt/document/698905/telecomcontractupdate_ppt.

Commonwealth of Pennsylvania, *2010 NASCIO Awards, Improving State Operations, COPANET*, accessed January 3, 2011,
<http://www.nascio.org/awards/nominations/2010/2010PA7-PA-CoPANet-Improving%20Operations.pdf>.

Commonwealth of Pennsylvania, *2010 NASCIO Awards, Information Communications Technology Innovation, Pennsylvania STARNet*, accessed September 24, 2010,
<http://www.nascio.org/awards/nominations/2010/2010PA8-PA%20-%20StarNET%20-%20Info.%20Communications%20Technology%20Innovation.pdf>.

Commonwealth of Pennsylvania, *2010-11 Spending Reductions, General Fund - State Funds, August 2010*, accessed February 11, 2011,
http://www.portal.state.pa.us/portal/server.pt/document/938102/10-08-31_2010-11_enacted_tr_wtih_10-11_freeze_web_version_pdf?qid=59602566&rank=1.

Commonwealth of Pennsylvania, *Governor's Executive Budget 2010-2011*, February 9, 2010, accessed September 21, 2010,
http://www.portal.state.pa.us/portal/server.pt/document/768989/2010-11_budget_document_cd_pdf.

- Commonwealth of Pennsylvania, Governor's Office, *Enterprise Information Technology Governance Board*, "Executive Order 2004-8, as amended," accessed September 15, 2010, http://www.portal.state.pa.us/portal/server.pt/gateway/PTARGS_0_2_785_708_0_43/http%3B/pubcontent.state.pa.us/publishedcontent/publish/global/files/executive_orders/2000_2009/2004_8_as_amended.pdf.
- Commonwealth of Pennsylvania, Office of Public Safety Radio Services, *Statewide Communications Interoperability Plan (SCIP)*, Version 1.1, March 12, 2008, accessed September 24, 2010, <http://www.portal.state.pa.us/portal/server.pt?open=18&objID=337341&mode=2>.
- Commonwealth of Pennsylvania, *Schedule E, Critical Services*, accessed September 1, 2010, http://contracts.patreasury.org/Admin/Upload/69699_12-Sched_E-0_FINAL_20091016.pdf.
- Commonwealth of Pennsylvania, *Schedule F, Service Level Methodology*, accessed September 1, 2010, http://contracts.patreasury.org/Admin/Upload/69699_14-Sched_F-0_FINAL_20091016.pdf.
- Commonwealth of Pennsylvania, Office of Administration/Information Technology. Request for Proposals, *General Description of Documents*, "Schedule O," accessed September 3, 2010, http://contracts.patreasury.org/Admin/Upload/69699_29-B_RFP_Pt1.pdf.
- Congressional Budget Office, *Budget Options, Volume I: Health Care*, December 2008, <http://www.cbo.gov/ftpdocs/99xx/doc9925/12-18-HealthOptions.pdf>.
- Connect Florida, *Connect Florida Business Technology Overview in Compliance with State and NTIA Requirements*, No Date.
- Connect Florida, *Connect Florida Residential Technology Assessment, March 2010*.
- Connolly, Ceci, "For This Health System, Less Is More: Program That Guarantees Doing Things Right the First Time, for Flat Fee, Pays Off," *Washington Post*, March 31, 2009.
- Corcoran, Daniel J., New York State, Chief Information Officer, Office for Technology, "NYS Office of General Services Telecommunications Symposium," December 9, 2009, accessed September 12, 2010, <http://www.ogs.state.ny.us/purchase/snt/awardnotes/OftSymposium.pps>.
- Crabbe, Nathan, "Board Awards UF Grants Worth \$2.45M," *The Gainesville Sun*, November 15, 2010, <http://www.gainesville.com/article/20101115/articles/101119599>.

- Cubbin, John, and Jon Stern. "The Impact of Regulatory Governance and Privatization on Electricity Industry Generation Capacity in Developing Economies," *The World Bank Economic Review* 20, no. 1 (2006): 115-41.
- Cuervo, Alvaron and Belén Villalonga. "Explaining the Variance in the Performance Effects of Privatization," *The Academy of Management Review* 25, no. 3 (2000): 581-590.
- Cusack, Caitlin, Eric Pan, Julie Hook, Adam Vincent, David Kaelber, David Bates, and Blackford Middleton, *The Value of Provider to Provider Telehealth Technologies*, Massachusetts: Center for Information Technology Leadership, 2007.
- Dahl, Robert A., "The Science of Public Administration: Three Problems," *Public Administration Review* 7, no. 1, (1947): 1-11.
- De Haes, Stephen, and William Van Grembergen, "Moving from IT Governance to Enterprise Governance of IT," *ISACA Journal* 3, (2009), accessed January 24, 2011, <http://www.isaca.org/Journal/Past-Issues/2009/Volume-3/Documents/jpdf0903-moving-from-it-gov.pdf>.
- Department of Central Management Services, Bureau of Communications and Computer Services, *Telecommunications Service Intervals: Target Timelines*, October 27, 2010, accessed November 22, 2010, http://bccs.illinois.gov/pdf/Wire_Service_Intervals_Targets.pdf.
- Department of Management Services, "3G/4G Unlimited Connect Plan," accessed January 7, 2011, http://dms.myflorida.com/suncom/suncom_products_and_pricing/wireless_services/wireless_data_services_aircard/rate_schedule/3g_4g_connect_unlimited_plan.
- Department of Management Services, "Data Transport Services," accessed August 29, 2010, http://dms.myflorida.com/suncom/suncom_products_and_pricing/data_transport_services.
- Department of Management Services, "Erate Contract for Internet Access and Telecommunications Services (FIRN)," accessed January 5, 2011, http://dms.myflorida.com/suncom/suncom_products_and_pricing/data_transport_services/erate_contract_for_internet_access_and_telecommunications_services_firn.
- Department of Management Services, "FIN Implementation," accessed January 9, 2011, http://dms.myflorida.com/suncom/public_safety_bureau/radio_communications/florida_interoperability_network_fin/florida_s_interoperability_strategy/fin_implementation.

Department of Management Services, “Florida’s Interoperability Strategy,”
http://dms.myflorida.com/suncom/public_safety_bureau/radio_communications/florida_interoperability_network_fin/florida_s_interoperability_strategy.

Department of Management Services, “MyFloridaNet,” accessed August 29, 2010,
http://dms.myflorida.com/suncom/suncom_products_and_pricing/data_transport_services/myfloridanet .

Department of Management Services, “Rate Schedule,”
http://dms.myflorida.com/suncom/suncom_products_and_pricing/data_transport_services/myfloridanet/rate_schedule.

Department of Management Services, “Statewide Law Enforcement Radio System (SLERS),”
accessed January 9, 2011,
http://dms.myflorida.com/suncom/public_safety_bureau/radio_communications/statewide_law_enforcement_radio_system_slers.

Department of Management Services, “SUNCOM Products and Pricing,” accessed August 29,
2010, http://dms.myflorida.com/suncom/suncom_products_and_pricing.

Department of Management Services, “System Description,” accessed January 9, 2011,
http://dms.myflorida.com/suncom/public_safety_bureau/radio_communications/statewide_law_enforcement_radio_system_slers/system_description.

Department of Management Services, “Wireless Data Services: AirCard,” accessed January 7,
2011,
http://dms.myflorida.com/suncom/suncom_products_and_pricing/wireless_services/wireless_data_services_aircard.

Department of Management Services, “Wireless Data Services: AirCard Features/Options,”
accessed January 7, 2011,
http://dms.myflorida.com/suncom/suncom_products_and_pricing/wireless_services/wireless_data_services_aircard/features_options.

Department of Management Services, *Comments on the FCC 700 Waiver Order Filing Questions, In Re: 700 MHz Interoperable Broadband Public Safety Network*, October 18, 2010.

- Department of Management Services, Division of Human Resource Management, *Telecommuting: A Guide for Managers and Employees Considering a Voluntary Telecommuting Program*, December 2008, accessed November 13, 2010, http://dms.myflorida.com/index.php/content/download/1831/7810/version/5/file/Telecommuting_Gde-Final_12-04-08.doc.
- Department of Management Services, *Division of Telecommunications Business Model and Value 1st Edition*, White Paper, January 2011.
- Department of Management Services, Enterprise Information Technology Services, *MyFloridaSUNCOM Services, Portfolio*, revised August 24, 2006.
- Department of Management Services, *Invitation to Negotiate for Mobile Communication Services*, ITN No. DMS-10/11-008, Released September 2, 2010.
- Department of Management Services, *Long-Range Program Plan, Fiscal Years 2009-2010 through 2013-2014*, “Trends and Conditions Statement,” accessed January 30, 2011, http://dms.myflorida.com/agency_administration/planning_and_budget/long_range_program_plan_archive/2009_2010_through_2013_2014_long_range_program_plan.
- Department of Management Services, *Request for Proposal for NG-911 Statewide Routing Development*, RFP No.: DMS-10/11-013, Released January 7, 2011.
- Department of Management Services, *Request for Quotes, State Broadband Planning Initiative*, Short Term Contract No. 973-001-06-1, Management Consulting Services.
- Department of Management Services, *Request for Waiver of the Commission’s Rules to Allow Establishment of a 700 MHz Interoperable Mobile Public Safety Broadband Network*, PS Docket No. 06-229, August 3, 2010.
- DesRoches, Catherine, Eric Campbell, Sowmya Rao, Karen Donelan, Timothy Ferris, Ashish Jha, Rainu Kaushal, Douglas Levy, Sara Rosenbaum, Alexandra Shields, and David Blumenthal, “Electronic Health Records in Ambulatory Care - A National Survey of Physicians,” *The New England Journal of Medicine* 359 (2008): 50–57.
- DiNapoli, Thomas P., Office of the New York State Comptroller, Division of State Government Accountability, *New York State Office of General Services: Interagency Consolidation of Administrative and Support Services*, Report 2009-S-31, accessed August 2, 2010, <http://osc.state.ny.us/audits/allaudits/093010/09s31.pdf>.

- DrPeering International, "Tier 1 ISP," accessed January 30, 2011, <http://drpeering.net/white-papers/Ecosystems/Tier-1-ISP.html>.
- Edwards, Geoff, and Leonard Waverman. "The Effects of Public Ownership and Regulatory Independence on Regulatory Outcomes: A Study of Interconnect Rates in EU Telecommunications," *Journal of Regulatory Economics* 29, no. 1 (2006): 23-67.
- eTech Ohio, "eTech Ohio Eligibility for the Ohio K-12 Network Connectivity Subsidy," accessed September 22, 2010, <http://www.etech.ohio.gov/ohio-k-12-network/eligibility-k-12-network-connectivity-subsidy.dot>.
- Feasey, Richard, "Tools to Optimize Use of Current Supply," panel discussion, Columbia Institute for Tele-Information, The State of Telecom – 2010 Matching Supply and Demand for the Next Generation of Broadband, October 15, 2010, <http://www4.gsb.columbia.edu/citi/events/telecom2010>.
- Federal Communications Commission, *Joint Advisory Committee on Communications Capabilities of Emergency Medical and Public Health Care Facilities*, Report to Congress, February 4, 2008, http://www.general-devices.com/files/learning_pdf/JAC-Report_FINAL_Jan_3_2008.pdf.
- Federal Communications Commission, News Release, "FCC Enables High-Speed, Affordable Broadband for Schools and Libraries," September 23, 2010, accessed November 19, 2010, http://www.fcc.gov/Daily_Releases/Daily_Business/2010/db0923/DOC-301649A1.pdf.
- Federal Communications Commission, OBI Technical Paper No. 4: *Broadband Performance*, accessed July 2010, http://www.fcc.gov/Daily_Releases/Daily_Business/2010/db0813/DOC-300902A1.pdf.
- Federal Communications Commission, *Rural Telemedicine Program Funds 16 More Broadband Telehealth Networks: \$145 Million Provided To Connect Hundreds of Hospitals in Seventeen States*, February 2010.
- Federal Communications Commission, *Schools and Libraries Universal Service Support Mechanism a National Broadband Plan for Our Future*, CC Docket No. 02-6, GN Docket No. 09-51, FCC 10-175, *Sixth Report and Order*, Rel. September 28, 2010. Final Rule, Federal Register, Vol. 75, No. 232, p. 75393, Friday, December 3, 2010.

Federal Communications Commission, *The Broadband Availability Gap*, OBI Technical Paper No. 1, April 2010, <http://download.broadband.gov/plan/the-broadband-availability-gap-obi-technical-paper-no-1.pdf>.

Federal Communications Commission, *The National Broadband Plan, Connecting America*, <http://www.broadband.gov/plan/>.

Federal Communications Commission, *The National Broadband Plan, Connecting America*, Chapter 10, Health Care, accessed January 24, 2011, <http://www.broadband.gov/plan/10-healthcare/>.

Federal Communications Commission, *The National Broadband Plan, Connecting America*, Chapter 10, Health Care, <http://www.broadband.gov/plan/10-healthcare/>, citing, footnote 23, Center for Information Technology, Leadership, Health Care Information and Management Systems Society (HIMSS), “The Value of Provider-to-Provider Telehealth Technologies,” 2007, accessed January 24, 2011, <http://telehealth.utmb.edu/presentations/CITL%20-%202007%20-%20The%20Value%20of%20Provider-to-Provider%20Telehealth%20Technologies.pdf>.

Federal Communications Commission, *The National Broadband Plan, Connecting America*, Chapter 10, Health Care, <http://www.broadband.gov/plan/10-healthcare/>, citing, among others, footnote 27, Adam Darkins et al., “Care Coordination/Home Telehealth: The Systematic Implementation of Health Informatics, Home Telehealth, and Disease Management to Support the Care of Veteran Patients with Chronic Conditions,” *Telemedicine and e-Health*, 14, no. 10 (2008): 1118-1126, accessed January 24, 2011, <http://www.liebertonline.com/doi/abs/10.1089/tmj.2008.0021>.

Federal Communications Commission, *The National Broadband Plan, Connecting America*, Chapter 10, Health Care, “Health Care Providers’ Broadband Needs,” accessed January 24, 2011, http://www.broadband.gov/plan/10-healthcare/#_ifr078.

Federal Communications Commission, *The National Broadband Plan, Connecting America*, Chapter 10, Health Care, <http://www.broadband.gov/plan/10-healthcare/>, citing footnote 17, Richard Hillestad et al., “Can Electronic Medical Record Systems Transform Healthcare? Potential Health Benefits, Savings, and Costs,” *Health Affairs*, 24, no. 5 (2005): 1103-1117, accessed January 24, 2011, <http://content.healthaffairs.org/content/24/5/1103.full>.

Federal Communications Commission, *The National Broadband Plan, Connecting America*, Chapter 11, Education, Recommendation 11.15: The FCC Should Initiate a Rulemaking to Set Goals for Minimum Broadband Connectivity for Schools and Libraries and Prioritize Funds Accordingly, accessed July 2010, <http://www.broadband.gov/plan/11-education/>.

Federal Communications Commission, *The National Broadband Plan, Connecting America*, Chapter 14, Government Performance, <http://www.broadband.gov/plan/14-government-performance/>, citing footnote 91, U.S. Government Accountability Office (GAO), Report to the Chairman, Committee on Agriculture, Nutrition, and Forestry, U.S. Senate, *Food Stamp Program: Use of Alternative Methods to Apply for and Maintain Benefits Could be Enhanced by Additional Evaluation and Information on Promising Practices*, GAO-07-573 (2007), accessed November 13, 2010, <http://www.gao.gov/new.items/d07573.pdf>.

Federal Communications Commission, *The National Broadband Plan: Connecting America*, “Broadband and Public Safety,” accessed September 24, 2010, <http://www.broadband.gov/issues/public-safety.html>.

Federal Communications Commission, *The National Broadband Plan, Connecting America*, Chapter 16, Public Safety.

Federal Communications Commission, *The National Broadband Plan, Connecting America*, Chapter 16, Public Safety, quoting material preceding footnote 20, accessed November 13, 2010, http://www.broadband.gov/plan/16-public-safety/#_ednref20.

Federal Communications Commission, *Universal Service Monitoring Report CC Docket N. 98-202, 2010*, Table 1.12 “Universal Service Support Mechanisms by State: 2009,” accessed January 24, 2011, http://www.fcc.gov/Daily_Releases/Daily_Business/2010/db1230/DOC-303886A1.pdf.

Fiber-to-the-Home Council, *Consumer Usage Patterns and Attitudes of U.S. FTTH and Broadband Consumers*, Prepared by RVA LLC, August 2010, accessed February 9, 2011, http://s.ftthcouncil.org/files/rva_2010_consumer_study_report_0.pdf.

Florida College System, *Florida Smart Net*, “Executive Summary,” National Communications Information Administration, Broadband Technology Opportunity Program, Florida College System, Independent Colleges and Universities of Florida, and Florida Public Broadcasting Service, http://www.fldoe.org/board/meetings/2010_06_15/coversmart.pdf.

Florida Department of Education, *2011-2012 Legislative Budget Request, As Amended* September 21, 2010.

Florida Department of Education, *A Report to the Joint Library Planning Committee from the Technical Support Workgroup in Response to Section 81 Proviso, 2009 General Appropriations Act*, November 12, 2009, accessed January 31, 2011, <http://www.fldoe.org/cc/pdf/20091104JLPCReport-2.pdf>.

Florida Department of Education, *Florida Education Finance Program 2010-11, Third Calculation*, School Business Services, Office of Funding and Financial Reporting, December 22, 2010, accessed January 2, 2011, <http://www.fldoe.org/feftp/pdf/10-11-3rd-part1.pdf>.

Florida Department of Education, Press Release, November 18, 2009, e.Republic's Center for Digital Education, "National Survey Finds Substantial Increase in Online Education," accessed November 13, 2010, http://www.fldoe.org/news/2009/2009_11_18.asp.

Florida Department of Environmental Protection, *Progress Report: Office of Technology and Information Services Strategic Plan 2007-2012*, accessed November 13, 2010, http://www.dep.state.fl.us/resource/docs/2009_Strategic_Plan_Progress_Report.pdf.

Florida Department of Law Enforcement, *2010 Florida Data Sharing Status*, 2010 Florida CJIS Training Symposium, July 2010, accessed February 2, 2011, <http://www.fdle.state.fl.us/Content/getdoc/c26220a6-1f47-45b7-83d5-8e8a091393e4/2010CJIS---Florida-Data-Sharing-Final.aspx>.

Florida Department of Law Enforcement, *Statement of Agency Organization and Operation*, October 2010, <http://www.fdle.state.fl.us/Content/getdoc/ed464270-a6c5-4737-8680-bae4518d8fea/StatementOfAgencyOrganization.aspx>.

Florida Department of Law Enforcement, "Welcome to the Florida Law Enforcement Exchange (FLEX) Project," accessed February 2, 2011, <http://www.fdle.state.fl.us/content/getdoc/84fc2ffe-93ba-4b57-8c93-8ff4ac4a31b8/Flex-Home.aspx>.

Florida Department of Transportation, *Intelligent Transportation Systems Program Annual Report Fiscal Year 2008-2009*, accessed January 24, 2011, http://www.dot.state.fl.us/trafficoperations/ITS/Projects_Deploy/AnnualReports/Annual_Report-FY2008-09.pdf

Florida Department of Transportation, *Intelligent Transportation Systems Program Annual Report Fiscal Year 2009-2010*, accessed January 30, 2011, http://www.dot.state.fl.us/trafficoperations/ITS/Projects_Deploy/AnnualReports/Annual_Report-FY2009-10.pdf.

Florida House of Representatives, "House Broadcasts," accessed November 9, 2010, <http://www.myfloridahouse.gov/Sections/HouseCalendar/broadcast.aspx>.

Florida LambdaRail, "Florida LambdaRail Governance," accessed January 30, 2011, <http://www.flrnet.org/governance.cfm>.

Florida LambdaRail, "Infrastructure," accessed November 18, 2010, <http://www.flrnet.org/infrastructure.cfm>.

Florida LambdaRail, *Bi-Annual Report 2008 & 2009*, No date.

Florida LambdaRail, *Case Study* as prepared by The Quilt, White Paper, April 4, 2007.

Florida LambdaRail, *The Florida LambdaRail: Florida's Research and Education Network*, 2005, http://www.flrnet.org/docs/FLRCorpBrochure_Tabloid_FINAL.pdf.

Florida LambdaRail. *FLR: Cyber-Infrastructure for the New Economy*, 2009.

Florida League of Cities, *Municipal Officials' Manual*, 2008, accessed October 13, 2010, http://www.floridaleagueofcities.com/Assets/Files/Publications/Municipal_Officials_Manual.pdf

Florida Legislature, Office of Program Policy Analysis & Government Accountability, Government Program Summaries, "Department of Law Enforcement, Criminal Justice Information Services," accessed January 25, 2011, <http://www.oppaga.state.fl.us/profiles/1069>.

Florida Senate, "Video Broadcasts," accessed November 9, 2010, <http://www.flsenate.gov/Session/index.cfm?Mode=Video%20Broadcasts&Submenu=8&Tab=session>.

Florida Senate, *The Florida Senate, Interim Report 2011-115*, Committee on Education Pre-K-12, "School District Information Technology Procurement," October 2010, http://www.flsenate.gov/data/Publications/2011/Senate/reports/interim_reports/pdf/2011-115ed.pdf.

Florida Virtual School, accessed November 13, 2010, <http://www.flvs.net/Pages/default.aspx>.

Ford, George, and Thomas Koutsky, "Broadband and Economic Development: A Municipal Case Study from Florida," *Review of Urban and Regional Development Studies* 17 (2005): 216–229.

Gainesville Regional Utilities, *Annual Report 2008-2009*, 2010.

Ghini, Charles, *Renewal versus Rebid of the MyFloridaNet Contract: An Analysis*, Tallahassee: Division of Telecommunications, Department of Management Services, August 9, 2010.

Ghini, Charles, *Strategic Plan 2009-2014* (draft), Tallahassee: Division of Telecommunications, Department of Management Services, April 2010.

Gionfriddo, Paul, "Florida's Health Information Network: What Will It Cost to Develop?" *Florida Health Policy Center*, February 2007.

Gross, Donald, and Carl M. Harris. *Fundamentals of Queuing Theory*. Third Edition, New York, NY: John Wiley & Sons, Inc., 1998.

GRUCom Response to 2009 Local Broadband Inventory Survey Conducted by the Department of Management Services, August 2009.

Halstead, Phillip J., "Florida's Infrastructure Needs: Adequate Broadband Capacity is Essential in the New Economy," *The Journal of the James Madison Institute*, Fall (2010): 57-62, http://jamesmadison.org/wp-content/uploads/pdf/materials/Journal_Fall2010.pdf.

Hansell, Saul, "Verizon's FiOS: A Smart Bet or a Big Mistake?" *The New York Times*, August 18, 2008, <http://www.nytimes.com/2008/08/19/technology/19fios.html>.

Harvard University, Ash Center for Democratic Governance and Innovation, "New Bright Ideas Recognizes Innovative Government," accessed November 19, 2010, <http://ash.harvard.edu/Home/News-Events/Press-Releases/New-Bright-Ideas-Program-Recognizes-Innovative-Government-Programs>.

Hayes e-Government Resources, Inc., *Hayes, IT Consulting Technology Assessment Report, Florida Broadband Capacity Planning Project, State Library and Archives of Florida*, August 2010, accessed January 31, 2011, http://dlis.dos.state.fl.us/bld/Library_Tech/pdfs/HayesStateLibraryReportAugust2010.pdf.

- Hein, Matthew, *Telemedicine: An Important Force in the Transformation of Healthcare*, U.S. Department of Commerce, International Trade Administration, June 25, 2009, http://www.ita.doc.gov/td/health/telemedicine_2009.pdf.
- Heinisz, W., and B.A. Zelner. "The Institutional Environment for Telecommunications Investment," *Journal of Economics and Management Strategy* 10, no. 1 (2001): 123-147.
- Hillestad, Richard, James Bigelow, Anthony Bower, Federico Girosi, Robin Meili, Richard Scoville, and Roger Taylor, "Can Electronic Medical Record Systems Transform Health Care? Potential Health Benefits, Savings, and Costs," *Health Affairs* 24, no. 5, (2005): 1103–1117.
- Holt, Lynne, and Theodore Kury. 2009. "Florida's Plans to Finance New Nuclear Plants," *Bulletin of the Atomic Scientists* 65, no. 4 (2009): 31-40.
- Hrdinová, Jana, Natalie Helbig, and Anna Raup-Kounovsky, *Enterprise IT Governance in State Government: State Profiles*, Center for Technology in Government, University at Albany, SUNY, 2009, accessed September 28, 2010, http://www.ctg.albany.edu/publications/reports/itgov_profiles/itgov_profiles.pdf.
- Illinois Bureau of Communication and Computer Services, *Pulse Newsletter* 3, no. 3, Fall 2009, accessed November 9, 2010, http://bccs.illinois.gov/pdf/bccs_pulse_fall_2009.pdf.
- Illinois Century Network, *Illinois Century Network Service Agreement*, "ICN/CMS and the Champaign County Courthouse," May 2010, accessed August 7, 2010, <http://www.co.champaign.il.us/contracts/IllinoisCenturyNetworkServiceAgree.pdf>.
- Illinois Century Network, *Network Services Participation Agreement*, accessed November 12, 2010, <http://www.illinois.net/pdf/Participation%20agreement%20Final.pdf>.
- Illinois Century Network, *Provisions for Universal Service ("E-Rate") Program for Schools and Libraries – Letter of Agency*, accessed September 24, 2010, <http://www.illinois.net/pdf/ICN%20E%2%80%90rate%20LOA%20year9%E2%80%9011.pdf>.
- Illinois Century Network, *Regional Meetings*, October 2010, accessed November 9, 2010, http://www.illinois.net/IBOP/IBOP_EastCentral/ICN_2010RegionalMtgs.pdf.
- Illinois Department of Central Management Services, "Regional Technology Centers," accessed November 18, 2010, <http://www.illinois.net/rtc/default.htm>.

Illinois Department of Central Management Services, Bureau of Communication and Computer Services, “BCCS Services: Wireless - Illinois Wireless Information Network (IWIN),” accessed November 18, 2010, http://bccs.illinois.gov/BCCScatalog/services/Wire_iwin.htm.

Illinois Department of Central Management Services, Bureau of Communication and Computer Services, *IWIN Subscriber List – Municipalities*, accessed November 18, 2010, http://bccs.illinois.gov/pdf/iwin/IWIN_User_List.pdf.

Illinois Department of Central Management Services, Bureau of Communication and Computer Services, *State of Illinois - IT Guiding Principles*, August 2008, accessed September 24, 2010, http://bccs.illinois.gov/governance/documents/State_of_Illinois_Guiding_Principles.pdf.

Illinois Department of Central Management Services, Bureau of Communication & Computer Services, *Server Consolidation & Virtualization*, accessed September 10, 2010, <http://www.nascio.org/awards/nominations/2010/2010IL7-BCCSServerConsolidation%20final%20submission.pdf>.

Illinois Department of Central Management Services, *The Next Illinois Century Network: A Vision and Strategic Plan*, May 2007, accessed July 22, 2010, <http://www.illinois.net/pdf/Next%20Century%20Report/May%202007/Next%20Century%20Report%205.07.pdf>.

Illinois Wireless Infrastructure for Research and Education, “The State of Illinois I-Wire Project,” accessed November 1, 2010, <http://www.iwire.org/>.

Indiana University, Pervasive Technology Institute, “Facilities-based Regional Optical Networks,” revised May 19, 2010, accessed October 30, 2010, http://paintsquirl.ucs.indiana.edu/RON/archive/fiber_map_current.pdf.

Information Please Database, “Per Capita Personal Income by State,” citing U.S. Department of Commerce, Bureau of Economic Analysis, “Survey of Current Business” accessed January 21, 2011, <http://www.infoplease.com/ipa/A0104652.html>.

Intelligent Transportation Society of Florida, *Intelligent Transportation Systems: The Future Has Arrived for Florida*, pamphlet, October 2005.

Intelligent Transportation Society of Florida, *ITS Florida* pamphlet, No Date.

ISACA, "IT Professional Networking and Knowledge Center,"
<http://www.isaca.org/Knowledge-Center/Pages/default.aspx>.

IT Governance Institute, *IT Governance Roundtable: IT Governance Trends*, 2007, accessed September 15, 2010,
http://www.itgi.org/AMTemplateebff.pdf?Section=ITGI_Research_Publications&Template=/ContentManagement/ContentDisplay.cfm&ContentID=40353.

Jamison, Mark A. "Cost Concepts for Utility Regulators." University of Florida, Department of Economics, Public Utility Research Center Working Paper, 2006.

Jamison, Mark A. "Regulation: Rate of Return." In *Encyclopedia of Energy Engineering and Technology Vol. 3*, edited by Barney Capehart, 1252-57. New York: CRC Press, Taylor and Francis, 2007.

Jamison, Mark A. "The 1st Academic Conference on the Auspicious Occasion of His Majesty the King's 80th Birthday Anniversary: The Importance of Telecommunications Development." In *NTC Annual Review Vol. 1*, 58-87. Bangkok: National Telecommunications Commission of Thailand, 2007.

Jamison, Mark A. "The Role of Costing as a Ratemaking Tool in an Environment of Dynamic Change." In *The Institutional Approach to Public Utilities Regulation*, edited by Edythe Miller and Warren J. Samuels, 250-75. East Lansing: Michigan State University Press, 2002.

Jha, Ashish, Catherine DesRoches, Eric Campbell, Karen Donelan, Sowmya Rao, Timothy Ferris, Alexandra Shields, Sara Rosenbaum, and David Blumenthal, "Use of Electronic Health Records in U.S. Hospitals," *The New England Journal of Medicine* 360, no. 16, (2009): 1628–1637.

Johnston, Douglas, Eric Pan, Blackford Middleton, Janice Walker, and David Bates, *The Value of Computerized Provider Order Entry in Ambulatory Settings*, Center for Information Technology Leadership, Executive Preview, 2002.

Kahn, Alfred E., *The Economics of Regulation, Volume I: Principles*. Cambridge, MA: The MIT Press, 1995.

Kaiser Permanente, "Kaiser Pilot Results in Reduction of Heart Attack Deaths by 73 Percent." *Health IT News*, 2009.

- Kansas Legislative Post Audit Committee, *Performance Audit Report, Agency Data Centers: A K-GOAL Audit Assessing the Potential Savings of Consolidation*, Prepared by the Kansas Legislative Division of Post Audit, July 2010, accessed February 2, 2011, http://www.kansas.gov/postaudit/audits_perform/09pa06a.pdf.
- Keystone Initiative for Network Based Education and Research, “Draft By-Laws of KINBER,” accessed January 30, 2011, https://www.kinber.org/index.php?option=com_content&view=article&id=51&Itemid=65.
- Keystone Initiative for Network Based Education and Research, “KINBER and PennREN Overview,” accessed August 19, 2010, https://www.kinber.org/index.php?option=com_content&view=article&id=52:about-pennren&catid=36:kpublicdocuments&Itemid=62.
- Laffont, Jean-Jacques, and David Martimort. *The Theory of Incentives: The Principal-Agent Model*. Princeton, New Jersey: Princeton University Press, 2002.
- Laffont, Jean-Jacques, and Jean Tirole. *A Theory of Incentives in Procurement and Regulation*. Cambridge, MA: The MIT Press, 1994.
- Le, Phong, “Tools to Optimize Use of Current Supply,” panel discussion, Columbia Institute for Tele-Information, The State of Telecom – 2010 Matching Supply and Demand for the Next Generation of Broadband, October 15, 2010, <http://www4.gsb.columbia.edu/citi/events/telecom2010>.
- Magellan Advisors, LLC, *Local Government Communications Use and Municipal Broadband Development, December 18, 2010*.
- McGlynn, Elizabeth, Steven Asch, John Adams, Joan Keese, Jennifer Hicks, Alison DeCristofaro, and Eve Kerr, “The Quality of Health Care Delivered to Adults in the United States,” *The New England Journal of Medicine* 348 (2003):2635–2645.
- Menachemi, Nir, Darrell Burke, Art Clawson, and Robert Brooks, “Information Technologies in Florida’s Rural Hospitals: Does System Affiliation Matter?” *The Journal of Rural Health* 21, no. 3, (2005): 263-68.
- Monegain, Bernie, “Kaiser Pilot Results in Reduction of Heart Attack Deaths by 73 Percent,” *Health IT News*, March 27, 2009.

Moore, Mark H., *Creating Public Value: Strategic Management in Government*, Cambridge, MA: Harvard University Press, 1995.

Multi-Agency Radio Communications System, *MARCS Task Force Report*, April 1, 2010
<http://www.das.ohio.gov/LinkClick.aspx?fileticket=JlQ6gnAbyJY%3d&tabid=538>.

MyFloridaNet Contract, an IP Core Routed Network; ITN No. 14-973-800-R, 9-15-2006;
Contract by and between the State of Florida Acting through the Department of Management Services and BellSouth Telecommunications, Inc.

National Advisory Committee on Rural Health and Human Services, *The 2006 Report to the Secretary: Rural Health and Human Services Issue*, January 2006, accessed January 27, 2011, <ftp://ftp.hrsa.gov/ruralhealth/NAC06forweb.pdf>.

National Association of State Chief Information Officers, *IT Governance and Business Outcomes – A Shared Responsibility between IT and Business Leadership*, March 2008, accessed September 15, 2010, <http://www.nascio.org/publications/documents/NASCIO-ITGovernanceBusinessOutcomes.pdf>.

National Association of State Chief Information Officers, “Publications and Research,”
<http://www.nascio.org/publications/>.

National Association of State Chief Information Officers, “Awards and Recognition, 2001 Awards: Information Architecture,” accessed September 17, 2010,
<http://www.nascio.org/awards/2001awards/architecture.cfm>.

National Center for Supercomputing Applications, University of Illinois Urbana-Champaign, NCSA press release, July 16, 2002, “I-WIRE Activation First Step toward National TeraGrid Network,” accessed January 31, 2011,
http://access.ncsa.illinois.edu/Releases/02Releases/07.16.02_I-WIRE_Act.html.

National Conference of State Legislatures, *2010 Legislation on Telecommuting, Flexible Schedules or Alternative Work Weeks*, accessed December 6, 2010,
<http://www.ncsl.org/default.aspx?tabid=21268>.

National Conference of State Legislatures, *State and Regional Telecommuting Coordinating Agencies*, accessed December 6, 2010,
<http://www.ncsl.org/Portals/1/documents/employ/telecommuteagencies.pdf>.

National Conference of State Legislatures, *State Telecommuting Statutes*, Updated 01/22/2008, accessed November 13, 2008,

<http://www.ncsl.org/Portals/1/documents/employ/telecommutestatutes.pdf>.

National LambdaRail, “Services Map by Point-of Presence,” accessed September 23, 2010,

<http://www.nlr.net/services-map.php>.

National Telecommunications and Information Administration, “State Broadband Data and Development Grant Program,” Notice of Funds Availability and Solicitation of Applications, Federal Register, Vol. 74, No. 129, Wednesday, July 8, 2009, accessed January 25, 2011,

http://www.ntia.doc.gov/frnotices/2009/FR_BroadbandMappingNOFA_090708.pdf.

National Telecommunications and Information Administration, *Broadband USA Applications Database*, accessed January 22, 2011,

<http://www.ntia.doc.gov/broadbandgrants/applications/summaries/7380.pdf>.

National Telecommunications and Information Administration, Broadband USA, “Grants Awarded,” <http://www2.ntia.doc.gov/awards>.

National Telecommunications and Information Administration, BroadbandUSA, Connecting America’s Communities, “Illinois,” accessed September 27, 2010,

<http://www2.ntia.doc.gov/illinois>.

National Telecommunications and Information Administration, *Broadband USA Applications Database*, “Illinois Broadband Opportunity Partnership East Central Region,” accessed August 5, 2010,

<http://www.ntia.doc.gov/broadbandgrants/applications/summaries/4243.pdf>.

National Telecommunications and Information Administration, *Broadband USA Applications Database*, “Illinois Broadband Opportunity Partnership Northwest Region,” accessed October 4, 2010,

<http://www.ntia.doc.gov/broadbandgrants/applications/summaries/6681.pdf>.

National Telecommunications and Information Administration, *Broadband USA Applications Database*, “DeKalb Advancement of Technology Authority Broadband,” accessed October 5, 2010,

<http://www.ntia.doc.gov/broadbandgrants/applications/summaries/2823.pdf>.

National Telecommunications and Information Administration, BroadbandUSA, Connecting America’s Communities, “New York,” accessed September 28, 2010,

<http://www2.ntia.doc.gov/>.

National Telecommunications and Information Administration, BroadbandUSA, Connecting America's Communities, "Ohio," accessed September 27, 2010, <http://www2.ntia.doc.gov/ohio>.

National Telecommunications and Information Administration, BroadbandUSA, Connecting America's Communities, "Pennsylvania," accessed September 27, 2010, <http://www2.ntia.doc.gov/pennsylvania>.

New York State, Chief Information Officer, Office for Technology, "Managed Network Services, OneNetNYS Network Integration," accessed February 11, 2011, http://www.cio.ny.gov/managed_network_services.

New York State, Chief Information Officer, Office for Technology, *Service Level Agreement for Enterprise IT Shared Services*, Revised October 7, 2010, accessed February 11, 2011, http://www.cio.ny.gov/assets/documents/SLA/GENERIC_SLA.pdf.

New York State, Chief Information Officer, Office for Technology, *Enterprise IT Shared Services, Service Level Agreement: Customer Networking Solutions Details*, Revision Date: September 15, 2010, accessed November 17, 2010, <http://www.cio.ny.gov/assets/documents/SLA/NYSManagedNetworkingFeatures.pdf>

New York State, Chief Information Officer, Office for Technology, *Enterprise IT Shared Services, Service Level Agreement: Enterprise Data Center Service Details*, September 15, 2010, accessed January 31, 2011, <http://www.cio.ny.gov/assets/documents/SLA/NYSEnterpriseDataCenterFeatures.pdf>.

New York State, Chief Information Officer, Office for Technology, *Enterprise IT Shared Services, Service Level Agreement: NYeNet Service Details*, September 15, 2010, accessed September 20, 2010, <http://www.cio.ny.gov/assets/documents/SLA/NYeNetfeatures.pdf>.

New York State, Chief Information Officer, Office for Technology, *Performance Dashboard of Service Level Performance Measurements by Service Delivery Type*, September 15, 2010, accessed September 20, 2010, <http://www.cio.ny.gov/assets/documents/SLA/AppendixA.pdf>.

New York State, Chief Information Officer, Office for Technology, *Connecting New York to the World for Sustainable Adoption*, New York State Universal Broadband Strategic Roadmap, New York State Council for Universal Broadband, June 2009, accessed September 21, 2010, http://www.cio.ny.gov/assets/documents/Final_Broadband_Strategy_June2009.pdf.

New York State, Chief Information Officer, Office for Technology, “FCC Grants Conditional Approval of New York State’s Interoperable Public Safety Waiver,” May 13, 2010, accessed September 29, 2010, <http://www.cio.ny.gov/news/051310-1.htm>.

New York State, Chief Information Officer, Office for Technology, *Transforming Information Technology Delivery: New York State Enterprise Information Technology Strategic Plan 2009-2012*, accessed February 7, 2011, <http://www.cio.ny.gov/assets/documents/ITStrategicPlan072909.pdf>.

New York State, Chief Information Officer, Office for Technology, *New York State Strategic I.T. Clusters Charter*, Revision Date July 29, 2010, accessed September 20, 2010, <http://www.cio.ny.gov/assets/documents/ITClusterCharter.pdf>.

New York State, Division of the Budget, *Request for Proposals, IT Management Consulting Services*, accessed November 16, 2010, <http://www.budget.state.ny.us/contract/itMgtConsulting/ITManagementConsultingRFP.pdf>.

New York State, Education Department, “E-Rate Resource Center,” accessed September 24, 2010, <http://www.e-ratecentral.com/us/nys/default.asp>.

New York State, Office of Homeland Security, *Annual Report 2008*, accessed September 25, 2010, http://www.security.state.ny.us/publications/OHS_Annual_Report_2008.pdf.

New York State Library, “E-Rate (Universal Service for Telecommunications Discounts Program) for Libraries,” accessed September 26, 2010, <http://www.nysl.nysed.gov/libdev/univsvc/>.

Newbery, David M. “Privatising Network Industries.” CESifo Working Paper No. 1132, CESifo Working Paper Series, Cambridge University, 2004.

North Florida Broadband Authority, *North Florida Broadband Authority Interim Business Plan*, April 2010, <http://www.nfba-fl.org/documents/NFBAInterimBusinessPlan.pdf>.

North Florida Economic Development Partnership, *North Florida Rural Area of Critical Economic Concern (RACEC) Broadband Feasibility Study*, Prepared by Government Services Group, No Date.

Office of Program Policy Analysis and Government Accountability, *Strategic Plan Developed to Enhance FIRN2 Services; Contract Awarded to New Provider*, Report No. 09-23, April 2009.

Ogden, Cynthia, and Margaret Carroll, *Prevalence of Overweight, Obesity, and Extreme Obesity among Adults: United States, Trends 1976-1980 through 2007-2008*, Center for Disease Control: National Center for Health Statistics, June 2010, accessed January 27, 2011, http://www.cdc.gov/NCHS/data/hestat/obesity_adult_07_08/obesity_adult_07_08.pdf.

Ohio Board of Regents, *FY 09 Budget Reductions*, January 2, 2009, accessed September 27, 2010, http://www.rpia.ohio-state.edu/committees/senfiscal/docs/01-06-09/FY09%20Budget%20Reductions%20Memo_1-2-09.pdf.

Ohio Broadband Council, *Ohio Broadband Council Minutes*, September 16, 2008.

Ohio Supercomputer Center, "Grant Funds Simulation & Modeling Study at Youngstown Firm," accessed September 23, 2010, http://www.osc.edu/press/releases/2010/EAGER_grant.shtml.

Ohio.gov., *Amendment 1 to Service Attachment 1, Opt-E-Man and CSME Service* between the Office of Information Technology and SBC Global Services, Inc. dba AT&T Global Services, accessed January 30, 2011, <http://www.das.ohio.gov/LinkClick.aspx?fileticket=2%2fshhTgW8d0%3d&tabid=361>.

Ohio.gov, Department of Administrative Services, Information Technologies. "Information Technology, Unified Network Services," accessed September 21, 2010, <http://www.das.ohio.gov/Divisions/InformationTechnology/UnifiedNetworkServices/tabid/125/Default.aspx>.

Ohio.gov., Department of Administrative Services, Information Technologies, "MARCS Services," accessed September 25, 2010, <http://das.ohio.gov/Divisions/InformationTechnology/MARCSServices/tabid/124/Default.aspx>.

Ohio.gov, "OARnet Network Partners," accessed September 24, 2010, <http://www.oar.net/network/partners.shtml>.

Ohio.gov, "Ohio Receives Additional \$111.3 Million in Broadband Recovery Act Awards." August 18, 2010, accessed September 24, 2010, http://www.oar.net/press/releases/2010/ommc_2.shtml.

Ohio.gov., "Ohio's Information Technology: Statewide IT Strategic Plan," accessed September 27, 2010, <http://it.ohio.gov/index.html>.

- Ohio.gov., *Service Attachment 5*, September 22, 2009, accessed September 27, 2010, <http://www.das.ohio.gov/LinkClick.aspx?fileticket=6hBdB4bw1yY%3d&tabid=361>.
- Organisation for Economic Co-operation and Development, *Broadband Portal*, Penetration Table 11, “Percentage of Fibre Connections in Total Broadband among Countries Reporting Fibre Subscribers,” December 2009, http://www.oecd.org/document/54/0,3343,en_2649_34225_38690102_1_1_1_1,00.html.
- Palm Beach County, News Release, “County’s Information Technology Services Rank Third in U.S. Among Large Counties,” July 20, 2010, accessed January 24, 2011, http://www.pbcgov.com/newsroom/0710/07-20-10_ISS_Rank.htm.
- Pardo, Theresa A., and G. Brian Burke, *IT Governance Capability: Laying the Foundation for Government Interoperability*, Center for Technology in Government, University at Albany, SUNY, October 2009, accessed September 28, 2010, http://www.ctg.albany.edu/publications/reports/it_gov_capability/it_gov_capability.pdf.
- Park, Todd, and Peter Basch, *A Historic Opportunity: Wedding Health Information Technology to Care Delivery Innovation and Provider Payment Reform*, Center for America Progress, May 2009, http://www.americanprogress.org/issues/2009/05/pdf/health_it.pdf.
- Pennsylvania Department of Education, *E-Fund Enabling 21st Century Connectivity for Learning: 2010 Program Background, Guidelines and Application Instructions*, August 2010, accessed February 11, 2011, http://www.portal.state.pa.us/portal/server.pt/document/1040519/2010efundguidelines_pdf.
- Pennsylvania Department of Education, Office of Commonwealth Libraries, *Technology Component Grant Application Guidelines*, 2011, Accessed September 24, 2010, http://www.portal.state.pa.us/portal/http://www.portal.state.pa.us;80/portal/server.pt/gateway/PTARGS_0_123484_887170_0_0_18/Application_2011_Technology_Components.pdf.
- Pennsylvania Office of Administration, *A Broadband Strategy for the 21st Century: High Speed Access to Digital Information for All Pennsylvanians*, July 2009, accessed September 21, 2010, http://www.recovery.pa.gov/portal/server.pt/gateway/PTARGS_0_2_50166_6052_506683_4_3/http%3B/pubcontent.state.pa.us/publishedcontent/publish/marketing/sites/recovery_pa_gov/content/hcigsm/hcigsm_content/pabroadbandplan_2009.pdf.

- Pennsylvania Statewide Radio Network, "Overview and Fact Sheet," accessed February 11, 2010, http://www.portal.state.pa.us/portal/http://www.portal.state.pa.us:80/portal/server.pt/gateway/PTARGS_0_151058_932295_0_0_18/PA-STARNet%20overview%20and%20fact%20sheet.pdf.
- Pepper, Robert, "Next Generation (Ultra Broadband) Demand," panel discussion, Columbia Institute for Tele-Information, The State of Telecom – 2010 Matching Supply and Demand for the Next Generation of Broadband, October 15, 2010, <http://www4.gsb.columbia.edu/citi/events/telecom2010>.
- Pittsburgh Supercomputing Center, "Pittsburgh Supercomputing Center Receives \$980,000 Software Development Award," accessed September 23, 2010, http://www.psc.edu/publicinfo/news/2010/090710_web10gig.php.
- Public Safety Spectrum Trust, "A Brief History of Public Safety Communications," accessed January 9, 2011, <http://psst.org/history.jsp>.
- Quilt, National Regional Networks Consortium, "Quilt Participants," accessed September 24, 2010, <http://www.thequilt.net/participants.html>.
- Reel, Jeff, "Keystone Initiative for Network Based Education and Research," presentation, Internet2 Member's Meeting, April 26-28, 2010, accessed September 24, 2010, https://www.kinber.org/index.php?option=com_docman&task=doc_download&gid=6&Itemid=53.
- Ross, Joe, "The Truth about LTE," *Public Safety Technology*, November-December 2010.
- Savedoff, William, and Pablo Spiller. "Government Opportunism and the Provision of Water." In *Spilled Water: Institutional Commitment in the Provision of Water Services*, edited by William Savedoff and Pablo Spiller, 1-34. Washington: Inter-American Development Bank, 1999.
- Schiff, Gordon, and David Bates, "Can Electronic Clinical Documentation Help Prevent Diagnostic Errors?" *New England Journal of Medicine* 362, no. 12, (2010):1066–69.
- Shores, Todd, Tony Obey, and Ryan Boal, "The Evolving E-prescribing Landscape," *Deloitte* 2010.

Smith, Aaron, *Government Online*, Pew Internet & American Life Project, Pew Research Center, April 27, 2010,
http://pewinternet.org/~media/Files/Reports/2010/PIP_Government_Online_2010_with_top_line.pdf.

Smith, Aaron, *Mobile Access 2010*, Pew Internet & American Life Project, Pew Research Center, July 7, 2010,
http://www.pewinternet.org/~media/Files/Reports/2010/PIP_Mobile_Access_2010.pdf.

Sorenson, Lori, “The Illinois Century Network Perspective,” presentation, National LambdaRail, 2010 All Hands Meeting, May 11-12, 2010, accessed November 29, 2010,
<http://www.nlr.net/ahm/speakers.php>.

South Florida Shared Fiber Initiative, “Position Paper,” Submitted to Ms. Elizabeth Birriel, Florida Department of Transportation, State Traffic Engineering and Operations Office, July 19, 2010.

Spiller, Pablo T. “Institutional Changes in Emerging Markets: Implications for the Telecommunications Sector.” In *Handbook of Telecommunications Economics: Volume 2*, edited by Sumit K. Majumdar, Ingo Vogelsang, and Martin E. Cave, 621-655. Amsterdam: North-Holland, 2005.

Standard & Poor’s, *Telecommunications, Wireless Industry Survey*, September 23, 2010.

State of Florida, Technology Review Workgroup, *Schedule Iv-C: Information Technology Costs & Service Requirements*, FY 2010-11.

State of Illinois, *Contract Approval Sheet*, “Cisco Equipment and Services RFP,” accessed September 21, 2010,
http://www.illinois.net/services/cisco/Cisco%20Equipment%20Services%20RFP_9.24.16.pdf.

State of Illinois, Department of Central Management Services, Bureau of Communications and Computer Services, *Customer Service Center: A Telecom Coordinator Guide to CSC Services*, Revised August 2009, accessed July 22, 2010,
<http://bccs.illinois.gov/pdf/telecom/TelecomGuide.pdf>.

State of Illinois, *Illinois Century Network Fiber Migration*, July 13, 2009, accessed July 22, 2010, <http://www.Illinois.net/FiberMigration09/FiberMigration7.09.pdf>.

- State of Illinois, *Statewide Communications Interoperability Plan, Illinois: A State of Interoperability*, Version 2.0, June 2010, accessed September 25, 2010, <http://www.state.il.us/iema/SCIP/SCIP.pdf>.
- State of Ohio, Office of Information Technology, *State of Ohio IT Policy: Authority of the State Chief Information Officer to Establish Policy Regarding the Acquisition and Use of Computer and Telecommunications Products and Services*, March 22, 2007, <http://www.das.ohio.gov/LinkClick.aspx?fileticket=r1HjIU0Md94%3d&tabid=107>.
- State of Ohio, Office of the Governor, Executive Order 2007- 24S, *Establishing the Ohio Broadband Council and Broadband Ohio Network*, issued July 26, 2007, accessed September 21, 2010, <http://www.ohiobroadbandcouncil.org/vision/ExecutiveOrder2007.pdf>.
- State of Ohio, Office of the Governor, *Specifying Revised Responsibilities for State Information Technology Governance*, Executive Order 2004-02T, January 2004, accessed September 16, 2010, http://media.centerdigitalgov.com/GT_Art/Ohio_IT_Responsibility.pdf.
- State of Ohio, *Statewide Communications Interoperability Plan*, March 2008, <http://das.ohio.gov/LinkClick.aspx?fileticket=Hs0knjHg9wA%3d&tabid=124>.
- State University of New York, “SUNYNet Services: SUNYNet Technology Services Overview,” accessed September 25, 2010, <http://www.suny.edu/sunynet/overview.cfm?navLevel=2>.
- Statewide Wireless Network Advisory Council, *2009 New York State Statewide Wireless Network Annual Report*, accessed September 24, 2010, <http://www.cio.ny.gov/assets/documents/2009SIPOAnnualReport.pdf>.
- Tofel, Kevin G., “T-Mobile Extends HSPA+ Ahead of the Data Demand Wave,” *GigaOM*, June 15, 2010, <http://gigaom.com/2010/06/15/t-mobile-extends-hspa-ahead-of-the-data-demand-wave>.
- Top 500 Supercomputer Sites, “Top500 List – June 2010,” accessed September 23, 2010, <http://www.top500.org/list/2010/06/100>.
- U.S. Census Bureau, “Population Finder,” accessed January 27, 2011, <http://www.census.gov/>.
- U.S. Department of Agriculture, Rural Development, “Telecommunications Loans and Grants,” accessed January 28, 2011, http://www.rurdev.usda.gov/UTP_Programs.html.

- U.S. Department of Education, National Center for Education Statistics, “State Education Data Profiles,” accessed January 21, 2011, <http://nces.ed.gov/programs/stateprofiles/>.
- U.S. Department of Health and Human Services, Health Resources and Services Administration, Bureau of Health Professions, *The Physician Workforce: Projections and Research into Current Issues Affecting Supply and Demand*, December 2008.
- U.S. Department of Homeland Security, “Interoperability,” accessed September 25, 2010, <http://www.safecomprogram.gov/SAFECOM/interoperability/default.htm>.
- U.S. Department of Homeland Security, *National Summary of Statewide Communication Interoperability Plans (SCIPs)*, February 2009, accessed September 25, 2010, http://www.safecomprogram.gov/NR/rdonlyres/C6C0CD6A-0A15-4110-8BD4-B1D8545F0425/0/NationalSummaryofSCIPs_February2009.pdf.
- U.S. General Accounting Office, Testimony before the Committee on Small Business, U.S. House of Representatives, *Facilities Location: Progress and Barriers in Selecting Rural Areas and Using Telework*, September 4, 2003, accessed November 14, 2010, <http://www.gao.gov/new.items/d031110t.pdf>.
- United States Unified Community Anchor Network, “National Research and Education Partnership Awarded \$62.5 Million Recovery Act Grant for 100 Gigabit Community Anchor Backbone Network,” July 2, 2010, accessed September 24, 2010, <http://www.usucan.org/news.html>.
- Universal Service Administrative Company, *2009 Annual Report*, accessed February 11, 2011, http://www.usac.org/_res/documents/about/pdf/usac-annual-report-2009.pdf.
- Universal Service Administrative Company, Database, accessed December 10, 2010, <http://www.usac.org/default.aspx>.
- Vajha, Phani Sasank, Sandeep Chelliboina, and Hyder Aga, *IT/Telecom Rationalization*, Department of Central Management Services, State of Illinois, Report Prepared for the 2006-2007 MBA/MS-MIS Class “Information Systems Strategies and Management” in the Department of Information & Decision Sciences, Liataud Graduate School of Business, University of Illinois at Chicago, accessed August 7, 2010, http://www.state.il.us/cms/download/pdfs/UIC_IT_Rationalization.pdf.

- Van der Berg, Rudolph, "How the Net Works: An Introduction to Peering and Transit," *Ars Technica*, September 2, 2008, <http://arstechnica.com/old/content/2008/09/peering-and-transit.ars/4>.
- Villalonga, Belén. "Privatization and Efficiency: Differentiating Ownership Effects from Political, Organizational, and Dynamic Effects," *Journal of Economic Behavior & Organization* 42, no. 1 (2000): 43-74.
- Walker, James, and Pascale Carayon, "From Tasks to Processes: The Case For Changing Health Information Technology To Improve Health Care," *Health Affairs* 28 (2009): 467-77.
- WellFlorida Council, Inc., *Florida Health Information Technology Environmental Scan*, Unpublished Draft, January 2011.
- Wieck, Reinhard, "Tools to Optimize Use of Current Supply," panel discussion, Columbia Institute for Tele-Information, The State of Telecom – 2010 Matching Supply and Demand for the Next Generation of Broadband, October 15, 2010, <http://www4.gsb.columbia.edu/citi/events/telecom2010>.
- Wilson, James Q., *Bureaucracy: What Government Agencies Do and Why They Do It*, New York, NY: Basic Books, 1989.
- Wyatt, Edward, "9 Years after 9/11, Public Safety Radio Not Ready," *The New York Times*, September 6, 2010.
- Yahoo Finance, "AT&T Inc., Key Statistics," accessed November 8, 2010, <http://finance.yahoo.com/q/ks?s=ATT>.
- Zales, Clare, M., Pennsylvania Department of Education, Office of Commonwealth Libraries, *Library Services and Technology Act Five-Year Plan 2008-2012, A Focused Program for the Improvement of Library Services for the People of Pennsylvania through Federal LSTA Funds*, Accessed September 25, 2010, <http://www.ims.gov/pdf/5yrplans/paplan2012.pdf>.
- Zhao, Houlin, "Telecommunications Services and Latest Development in Regulatory Frameworks," lecture, Multi-Year Expert Meeting on Services, Development and Trade: The Regulatory and Institutional Dimension, March 2010, http://www.unctad.org/sections/wcmu/docs/cImem3_2nd_ZHAO_en.pdf.
- Zurier, Steve, "Ohio's Higher Ed Engine," *EdTech*, <http://www.edtechmag.com/higher/september-october-2010/ohios-highered-engine-2.html>.